

MiLlennium GPSCard Software Versions 4.503 and 4.52

Command Descriptions Manual

```

ASCII Records [derv]
$POSA,908,138048.50,51.11642702,-114.03838505,1019.509,-16.271,61,24.753,19.492,57.948,0*2

Command Console [derv]
? -Online Command Help
ANTENNAPOWER -Antenna Power Control
CLOCKADJUST -Adjust lpps
COM2 -Initialize Port 2
COM2_DTR -DTR Control on Port 2
COM2_RTS -RTS Control on Port 2
CRESET -Factory Config Reset
DATUM -Choose a DATUM Type
DIFF_PROTOCOL -Diff. protocol control
ECUTOFF -Elevation Cutoff Angle
FIX -Set Antenna Coord.
FREQUENCY_OUT -Variable Freq. Output
LOCKOUT -Lock Out Satellite
MAGVAR -Set Magnetic Variation
POSAVE -Position Averaging
RESETHALTH -Reset PRN Health
RESETRT20 -Reset rt20 algorithm
RINEX -RINEX Configuration
RTCMRULE -Rtcm Bit Rule
SAVECONFIG -Save User Config.
SENDHEX -Send hex to a port
SETHALTH -Override PRN Health
SETHAV -Set a Destination
UNASSIGN -Un-Assign a Channel
UNDULATION -Choose Undulation
UNLOCKOUT -Restore Satellite
UNLOG -Kill a Data Log
USERDATUM -User Defined DATUM
Com> log com1 posa once
Com>
log com1 posa once
  
```

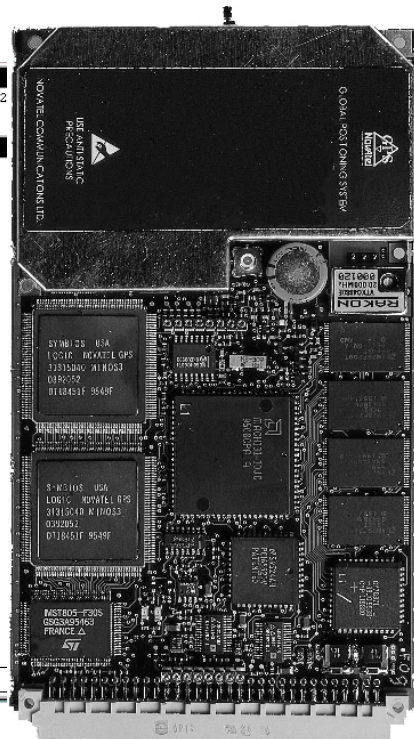

MiLLennium Command Descriptions Manual

Publication Number: OM-20000053

Revision Level: 2 2001/01/16

This manual reflects Software Versions 4.503 and 4.52

Proprietary Notice

Information in this document is subject to change without notice and does not represent a commitment on the part of NovAtel Inc.. The software described in this document is furnished under a licence agreement or non-disclosure agreement. The software may be used or copied only in accordance with the terms of the agreement. It is against the law to copy the software on any medium except as specifically allowed in the license or non-disclosure agreement.

No part of this manual may be reproduced or transmitted in any form or by any means, electronic or mechanical, including photocopying and recording, for any purpose without the express written permission of a duly authorized representative of NovAtel Inc.

The information contained within this manual is believed to be true and correct at the time of publication.

MiLLennium, NovAtel, Narrow Correlator, RT-20 and RT-2 are registered trademarks of NovAtel Inc.

GPSCard, GPSAntenna, GPSolution and Pinwheel are trademarks of NovAtel Inc.

All other brand names are trademarks of their respective holders.

© Copyright 2001 Novatel Inc. All rights reserved.

Unpublished rights reserved under International copyright laws.

Printed in Canada on recycled paper. Recyclable.



Table of Contents

Software License	10
Software Support	11
Foreword	12
Congratulations!.....	12
Scope.....	12
Prerequisites	12
What's New In This Manual?	12
1 Quick Start	13
1.1 Installation.....	13
Graphical Interface	13
1.2 Data Logging.....	14
1.3 Differential Operation.....	16
Establish a Data Link	16
Initialization - Reference Station.....	17
1.4 RTK Mode	18
Data Communications Link.....	18
System Initialization.....	19
Monitoring Your RTK Output Data.....	21
Options for Logging Differential Corrections.....	21
Initialization - Rover Station	22
2 Command Descriptions	24
2.1 General.....	24
Optional Calculation Of The Checksum	25
2.2 Standard Command Tables	26
2.3 WAAS.....	30
2.3.1 WAAS GPSCard.....	31
2.4 Special Data Input Commands.....	31
2.4.1 Almanac Data	31
2.4.2 Differential Corrections Data	33
3 Data Logs	35
3.1 Output Logging	35
3.2 NovAtel Format Data Logs.....	36
General	36
ASCII Log Structure	36
Binary Log Structure	36
3.3 RTK.....	37
3.4 NMEA Format Data Logs.....	38
General	38
3.5 GPS Time vs. Local Receiver Time.....	38
3.6 Standard Log Tables	39
3.7 WAAS.....	43
3.7.1 WAAS GPSCard Logs	43
3.8 Pass-Through Logs	43
3.8.1 Command Syntax	44
3.8.2 ASCII Log Structure	44
3.8.3 Binary Log Structure	45

4 Message Formats 46

4.1 RTCA-Format Messages.....	46
RTCA Standard Logs	47
4.2 RTCM-Format Messages.....	48
RTCM General Message Format	49
RTCM Standard Commands	50
RTCM Standard Logs	50
4.3 CMR Format Messaging.....	56
Using RT-2 or RT-20 with CMR Format Messages	57
4.4 RINEX Format.....	57
4.4.1 Commands.....	58
4.4.2 Logs.....	59

APPENDICES

A GPS Overview 63

A.1 GPS System Design	63
The Space Segment	63
The Control Segment.....	64
The User Segment	64
A.2 Height Relationships	64
A.3 GPS Positioning	65
Single-point vs. Relative Positioning	66
Static vs. Kinematic Positioning	67
Real-time vs. Post-mission Data Processing	67
Differential Positioning	67
Pseudorange Algorithms	68
Pseudorange Differential Positioning.....	68
Dual Station Differential Positioning.....	71
A.4 Carrier-Phase Algorithms.....	73

B Multipath Elimination Technology 75

B.1 Multipath	75
Why Does Multipath Occur?.....	75
Consequences of Multipath Reception.....	76
B.2 Hardware Solutions For Multipath Reduction	76
Antenna Site Selection	76
Antenna Designs.....	77
Antenna Ground Planes.....	78
NovAtel's Internal Receiver Solutions for Multipath Reduction.....	79

C Commands Summary 81

ACCEPT.....	81
ANTENNAPOWER.....	83
ASSIGN.....	84
CLOCKADJUST.....	85
COMn.....	86
COMn_DTR.....	86
COMn_RTS.....	87
CONFIG	88
CRESET	89
CSMOOTH	90
DATUM	91
DGPSTIMEOUT.....	92
DIFF_PROTOCOL	93

DYNAMICS.....	94
ECUTOFF.....	95
EXTERNALCLOCK.....	96
EXTERNALCLOCK FREQUENCY.....	98
FIX HEIGHT.....	99
FIX POSITION.....	100
FIX VELOCITY.....	101
FREQUENCY_OUT.....	102
FRESET.....	103
HELP.....	104
IONOMODEL.....	105
LOCKOUT.....	106
LOG.....	107
MAGVAR.....	108
MESSAGES.....	110
POSAVE.....	111
RESET.....	112
RESETHEALTH.....	113
RESETHEALTHALL.....	113
RINEX.....	114
RTCM16T.....	115
RTCMRULE.....	116
RTKMODE.....	117
SAVEALMA.....	121
SAVECONFIG.....	122
SEND.....	123
SENDHEX.....	124
SETDGPSID.....	125
SETHEALTH.....	126
SETL1OFFSET.....	127
SETNAV.....	128
SETTIMESYNC.....	130
UNASSIGN.....	131
UNASSIGNALL.....	131
UNDULATION.....	132
UNFIX.....	133
UNLOCKOUT.....	133
UNLOCKOUTALL.....	133
UNLOG.....	134
UNLOGALL.....	134
USERDATUM.....	135
VERSION.....	136
WAASCORRECTION WAAS.....	137

D Logs Summary 138

Log Descriptions.....	138
ALMA/B Decoded Almanac.....	138
BSLA/B Baseline Measurement RTK.....	143
CDSA/B Communication and Differential Decode Status.....	146
CLKA/B Receiver Clock Offset Data.....	149
CLMA/B Receiver Clock Model.....	151
CMR Standard Logs.....	153
COM1A/B and COM2A/B Pass-Through Logs.....	154
DOPA/B Dilution of Precision.....	155
ETSA/B Extended Tracking Status.....	157
FRMA/B Framed Raw Navigation Data.....	159
GGAB Global Position System Fix Data (Binary Format Only).....	160
GPALM Almanac Data.....	161

GPGGA	Global Position System Fix Data.....	162
GPGLL	Geographic Position	163
GPGRS	GPS Range Residuals for Each Satellite	164
GPGSA	GPS DOP and Active Satellites	165
GPGST	Pseudorange Measurement Noise Statistics	166
GPGSV	GPS Satellites in View	167
GPRMB	Navigation Information	168
GPRMC	GPS Specific Information	169
GPVTG	Track Made Good And Ground Speed.....	170
GPZDA	UTC Time and Date	171
GPZTG	UTC & Time to Destination Waypoint	172
MKPA/B	Mark Position.....	173
MKTA/B	Time of Mark Input.....	174
NAVA/B	Waypoint Navigation Data.....	175
PAVA/B	Position Averaging Status.....	178
POSA/B	Computed Position	180
PRTKA/B	Computed Position RTK	181
PVAA/B	XYZ Position, Velocity and Acceleration	183
PXYA/B	Computed Cartesian Coordinate Position.....	185
RALA/B	Raw Almanac.....	188
RASA/B	RAW ALMANAC SET	189
RBTA/B	Satellite Broadcast Data: Raw Bits	191
RCCA	Receiver Configuration	192
RCSA/B	Receiver Status	193
REPA/B	Raw Ephemeris.....	194
RGEA/B/D	Channel Range Measurements	195
RINEX	Receiver-Independent Exchange Format	204
RPSA/B	Reference Station Position and Health	205
RTCA	Standard Logs	206
RTCM	Standard Logs	206
RTKA/B	Computed Position - Time Matched RTK.....	207
RTKOA/B	RTK Solution Parameters RTK	209
RVSA/B	Receiver Status.....	212
SATA/B	Satellite Specific Data	214
SBTA/B	Satellite Broadcast Data: Raw Symbols.....	216
SPHA/B	Speed and Direction Over Ground	217
SVDA/B	SV Position in ECEF XYZ Coordinates with Corrections	218
TM1A/B	Time of 1PPS	220
VERA/B	Receiver Hardware and Software Version Numbers	221
VLHA/B	Velocity, Latency, and Direction Over Ground	222
WALA/B	WAAS Almanac WAAS	224
WEPA/B	WAAS Ephemeris WAAS	226
WRCA/B	Wide Band Range Correction (Grouped Format).....	228
WUTCA/B	UTC Time Parameters WAAS.....	229

E Comparison Of RT-2 And RT-20 231

E.1 RT-2 & RT-20 Performance.....	231
RT-2 Performance	232
RT-20 Performance	234
E.2 Performance Considerations	237
Performance Degradation.....	237

F Standards and References 239

G Geodetic Datums 240

H Some Common Unit Conversions 242

I	Information Messages	244
	Type 1 Information Messages.....	244
	!ERRA.....	244
	!MSGA.....	244
	Type 2 Information Messages.....	245
J	Listing Of Tables	248
K	GPS Glossary of Terms	267
L	GPS Glossary of Acronyms	275

Tables

1-1	GPSCard Pseudorange Differential Initialization Summary	17
1-2	Latency-Induced Extrapolation Error	18
2-1	Commands By Function	26
2-2	GPSCard Command Summary	28
3-1	Logs By Function	39
3-2	GPSCard Log Summary	42
4-1	Positioning Modes	46
C-1	Antenna LNA Power Configuration	83
C-2	Default Values of Process Noise Elements	97
D-1	GPSCard Solution Status	144
D-2	Position Type	145
D-3	RTK Status for Position Type 3 (RT-20)	145
D-4	RTK Status for Position Type 4 (RT-2)	145
D-5	Receiver Self-Test Status Codes	198
D-6	Range Record Format (RGED only)	201
D-7	Channel Tracking Status	203
D-8	Ambiguity Types	211
D-9	Searcher Status	211
D-10	RTK Status	211
D-11	GPSCard Range Reject Codes	215
D-12	GPSCard Velocity Status	223
D-13	Health and Status Bits	225
D-14	Data ID Type (Service Provider)	225
D-15	UTC Standard Identifier	230
E-1	Comparison of RT-2 and RT-20	231
E-2	RTK Messages Vs. Accuracy	231
E-3	RT-2 Performance: Static Mode	232
E-4	RT-2 Performance: Kinematic Mode	232
E-5	RT-2 Degradation With Respect To Data Delay t_d	232
E-6	RT-20 Performance	235
G-1	Reference Ellipsoid Constants	240
G-2	Transformation Parameters (Local Geodetic to WGS84)	240
I-1	Type 1 !ERRA Types	244
I-2	Type 1 !MSGGA Types	245

Figures

2-1	The WAAS Concept.....	30
3-1	Pass-Through Log Data.....	44
A-1	NAVSTAR Satellite Orbit Arrangement.....	63
A-2	Illustration of GPSCard Height Measurements.....	65
A-3	Accuracy versus Precision.....	66
A-4	Example of Differential Positioning.....	67
A-5	Single Point Averaging.....	71
A-6	Typical Differential Configuration.....	72
B-1	Illustration of GPS Signal Multipath.....	75
B-2	Illustration of GPS Signal Multipath vs. Increased Antenna Height.....	77
B-3	Illustration of Quadrifilar vs. Microstrip Patch Antennae.....	78
B-4	Comparison of Multipath Envelopes.....	80
C-1	HELP Command Screen Display.....	104
C-2	Appended Command Screen Display.....	104
C-3	Illustration of Magnetic Variation & Correction.....	109
C-4	Using SEND Command.....	123
C-5	Illustration of SETNAV Parameters.....	129
C-6	Illustration of Undulation.....	132
D-1	Example of Navigation Parameters.....	177
D-2	The WGS84 ECEF Coordinate System.....	187
E-1	Typical RT-2 Horizontal Convergence - Static Mode.....	233
E-2	Typical RT-2 Horizontal Convergence - Kinematic Mode.....	233
E-3	RT-2 Accuracy Convergence.....	234
E-4	Illustration of RT-2 Steady State Performance.....	234
E-5	Typical RT-20 Convergence - Static Mode.....	235
E-6	Typical RT-20 Convergence - Kinematic Mode.....	236
E-7	RT-20 Steady State Performance.....	236
E-8	RT-20 Re-initialization Process.....	238

SOFTWARE LICENSE

BY OPENING THE SEALED DISK PACKAGE YOU ARE AGREEING TO BE BOUND BY THE TERMS OF THIS AGREEMENT. IF YOU DO NOT AGREE TO THE TERMS OF THIS AGREEMENT PROMPTLY RETURN THE UNOPENED DISK PACKAGE AND THE ACCOMPANYING ITEMS TO NOVATEL INC.

1. License: NovAtel Inc. ("NovAtel") grants you a non-exclusive license (not a sale) to use one copy of the enclosed NovAtel software on a single computer, and only with the product whose model number and serial number appear on the envelope.
2. Copyright: NovAtel owns, or has the right to sublicense, all copyright, trade secret, patent and other proprietary rights in the software and the software is protected by national copyright laws, international treaty provisions and all other applicable national laws. You must treat the software like any other copyrighted material except that you may either (a) make one copy of the software solely for backup or archival purposes, or (b) transfer the software to a single hard disk provided you keep the original solely for backup or archival purposes. You may not copy the product manual or written materials accompanying the software.
3. Restrictions: You may not: (1) copy (other than as provided for in paragraph 2), distribute, rent, lease or sublicense all or any portion of the software; (2) modify or prepare derivative works of the software; (3) use the software in connection with computer-based services business or publicly display visual output of the software; (4) transmit the software over a network, by telephone or electronically using any means; or (5) reverse engineer, decompile or disassemble the software. You agree to keep confidential and use your best efforts to prevent and protect the contents of the software from unauthorized disclosure or use.
4. Term and Termination: This Agreement is effective until terminated. You may terminate it at any time by destroying the software, including all computer programs and documentation, and erasing any copies residing on computer equipment. If you do so, you should inform NovAtel in writing immediately. This Agreement also will terminate if you do not comply with any of its terms or conditions. Upon such termination you are obligated to destroy the software and erase all copies residing on computer equipment. NovAtel reserves the right to terminate this Agreement for reason of misuse or abuse of this software.
5. Warranty: For 90 days from the date of shipment, NovAtel warrants that the media (for example, diskette) on which the software is contained will be free from defects in materials and workmanship. This warranty does not cover damage caused by improper use or neglect. NovAtel does not warrant the contents of the software or that it will be error free. The software is furnished "AS IS" and without warranty as to the performance or results you may obtain by using the software. The entire risk as to the results and performance of the software is assumed by you.
6. For software UPDATES and UPGRADES, and regular customer support, contact the NovAtel GPS Hotline at **1-800-NOVATEL** (Canada and the U.S.A. only), or directly for International Customers **1-403-295-4900**, Fax **1-403-295-4901**, e-mail to support@novatel.ca, visit our world wide web site at <http://www.novatel.ca>, or write to:

**NovAtel Inc.
Customer Service Dept.
1120 - 68th Avenue NE
Calgary, Alberta,
Canada
T2E 8S5**

7. Disclaimer of Warranty and Limitation of Liability:

- a. THE WARRANTIES IN THIS AGREEMENT REPLACE ALL OTHER WARRANTIES, EXPRESS OR IMPLIED, INCLUDING ANY WARRANTIES OF MERCHANTABILITY OR FITNESS FOR A PARTICULAR PURPOSE. NOVATEL DISCLAIMS AND EXCLUDES ALL OTHER WARRANTIES. IN NO EVENT WILL NOVATEL'S LIABILITY OF ANY KIND INCLUDE ANY SPECIAL, INCIDENTAL OR CONSEQUENTIAL DAMAGES, INCLUDING LOST PROFITS, EVEN IF NOVATEL HAS KNOWLEDGE OF THE POTENTIAL LOSS OR DAMAGE.
- b. NovAtel will not be liable for any loss or damage caused by delay in furnishing the software or any other performance under this Agreement.
- c. NovAtel's entire liability and your exclusive remedies for our liability of any kind (including liability for negligence) for the software covered by this Agreement and all other performance or nonperformance by NovAtel under or related to this Agreement are limited to the remedies specified by this Agreement.

This Agreement is governed by the laws of the Province of Alberta, Canada. Each of the parties hereto irrevocably attorns to the jurisdiction of the courts of the Province of Alberta.

SOFTWARE SUPPORT

Software *updates* are software revisions to an existing model which improves (but does not increase) basic functionality of the GPS receiver. During the one year warranty coverage following initial purchase, software updates are supplied free of charge. After the warranty has expired, software updates and updated manuals may be subject to a nominal charge.

Software *upgrades* are software releases which increase basic functionality of the receiver from one model to a higher level model type. When available, upgrades can be purchased at a price which is the difference between the two model types on the current NovAtel GPS Price List plus a nominal service charge.

Software *updates* and *upgrades* are obtained through NovAtel authorized dealers or NovAtel Customer Support.

Contact your local NovAtel dealer for more information.

To locate a dealer in your area, contact NovAtel in any of the following ways:

- GPS Hotline at **1-800-NOVATEL** (1-800-668-2835)
(U.S.A. and Canada only; 8 a.m. - 4:30 p.m. Mountain Standard Time)
- telephone: **1-403-295-4900** (8 a.m. - 4:30 p.m. Mountain Standard Time)
- fax: **1-403-295-4901**
- e-mail: support@novatel.ca
- web site: <http://www.novatel.ca>
- postal address:

**NovAtel Inc.
Customer Service Dept.
1120 - 68th Avenue NE
Calgary, Alberta
Canada
T2E 8S5**

FOREWORD

Congratulations!

Thank you for purchasing a NovAtel GPSCard product.

Whether you have bought a stand alone GPSCard or a packaged receiver you will have also received companion documents to this manual. They will help you get the hardware operational. Afterwards, this text will be your primary MiLLennium GPSCard command and logging reference source.

Scope

The *MiLLennium Command Descriptions Manual* describes each command and log that the MiLLennium GPSCard is capable of accepting or outputting. Sufficient detail is provided so that you can understand the purpose, syntax, and structure of each command or log and be able to effectively communicate with the GPSCard, thus enabling the developer to effectively use and write custom interfacing software for specific needs and applications. The manual is organized into chapters which allow easy access to appropriate information about the GPSCard.

This manual does not address in detail any of the GPSCard hardware attributes or installation information. Please consult the appropriate companion manual for hardware or system technical specifications information. Furthermore, should you encounter any functional, operational, or interfacing difficulties with the GPSCard, consult the appropriate hardware manual for NovAtel warranty and customer support information.

Prerequisites

As this reference manual is focused on the GPSCard commands and logging protocol, it is necessary to ensure that the GPSCard has been properly installed and powered up according to the instructions outlined in the companion hardware manual before proceeding.

To use your NovAtel GPS receiver effectively, you should be familiar with the Global Positioning System (GPS) as it applies to positioning, navigation, and surveying applications. For your reference *Appendix A* of this manual provides an overview of the Global Positioning System.

This manual covers the full performance capabilities of all MiLLennium GPSCards. Every MiLLennium can be upgraded through a family of firmware models, each having unique features. Therefore, depending on the software configuration of your MiLLennium, certain commands and logs may not be accessible. Feature-tagging symbols have been created to help clarify which commands and logs are only available with a certain option:

<i>RTK</i>	Features available only with MiLLennium GPSCards equipped with the <u>RT-20 or RT-2 option</u>
<i>WAAS</i>	Features available only on MiLLennium GPSCards equipped with the WAAS/EGNOS option

What's New In This Manual?

This manual includes enhancements that apply to both Firmware 4.503 and 4.52 (Points #1 and #2 below). Points #3 to #6 are enhancements that apply only to Firmware 4.52.

1. Further WAAS/EGNOS capabilities with the additions to the WAASCORRECTION and IONOMODEL commands.
2. New WEPA/B and WUTCA/B logs.
3. Aircraft & Rapid Kinematic Application Optimization. Enhanced satellite tracking ability under demanding high velocity and rapidly changing altitude circumstances, especially applications involving aircraft and photogrammetry.
4. Improvements to L1 / L2 AGC Power Calculations. MiLLennium GPS Cards are now better equipped to handle increased ionospheric activity and atmospheric disturbances caused by the increasing solar activity of the approaching solar maximum.
5. Fixed TM1 log to correctly display the week field.
6. Decreased Sensitivity to RF Interference and Jamming. MiLLennium GPS Cards will now more accurately track L1 and L2 GPS signals through high levels of external RF interference. Examples of RF interference sources include intentional or accidental RF jamming and increased solar activity.

1 QUICK START

This chapter will help you get started quickly regardless of whether you wish to carry out real-time kinematic (RTK) positioning, operate in differential modes or simply log data. Each section references additional sources of information.

1.1 INSTALLATION

For more detailed instructions on the installation and set up of your GPSCard please refer to the accompanying *MiLlennium GPSCard Guide to Installation and Operation*.

The MiLlennium receiver is designed for flexibility of integration and configuration. You are free to select an appropriate data and signal interface, power supply system and mounting structure. This concept allows OEM purchasers to custom-design their own GPS-based positioning system around the MiLlennium GPSCard.

Installing the MiLlennium GPSCard typically consists of the following:

- Mount the GPSCard in a secure enclosure to reduce environmental exposure, RF interference and vibration effects
- Pre-wire the I/O harness and the 64-pin DIN female connector for power and communications, then connecting them to the OEM series GPSCard
- Install the GPSAntenna, then connect to the GPSCard
- (*Optional*) Install an external oscillator if additional precision and stability is required

OPERATION

Once the hardware and software installations have been completed, you are now ready to begin initial operation of the GPSCard receiver.

Communication with the MiLlennium GPSCard consists of issuing commands through the COM1 or COM2 port from an external serial communications device. This could be either a terminal or an IBM-compatible PC that is directly connected to a MiLlennium GPSCard COM port using a null modem cable.

TURNING ON

The initial operating software and firmware of the MiLlennium GPSCard resides in its read-only memory. As such, the unit “self-boots” upon power-up. The green LED indicator should blink about once per second if the unit is operating normally. The red one lights up if an error is detected during a self-test. The self-test status word can be viewed in the RGEA/B/D and RVSA/B data output logs.

If a persistent error develops please contact the NovAtel GPS Customer Service Department for further assistance

COMMUNICATION DEFAULT SETTINGS

COM1 and COM2 for the MiLlennium GPSCards are defaulted to the following RS232 protocol:

- 9600 bps, no parity, 8 data bits, 1stop bit, no handshake, echo off

Graphical Interface

Your GPSCard comes with a disk containing NovAtel’s graphical interface software GPSolution, a Microsoft Windows-based program, enabling you to use your GPSCard without struggling with communications protocol or writing make-do software.

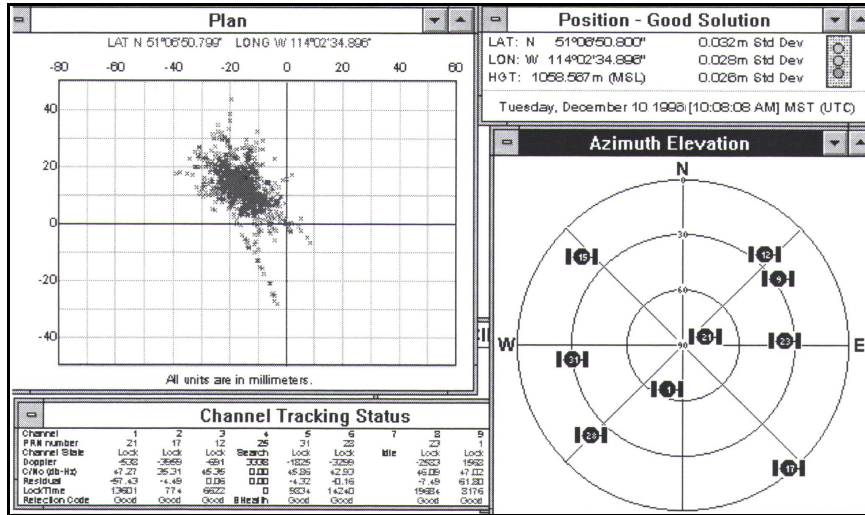

The View menu options allow you to select or de-select various visual aids and display screens. Take a look at all of the options and keep open those you wish to display. To send commands and log data the Command Console screen should be visible. ASCII format logs can be monitored on the ASCII Record screen.

e.g. On the command line of the Command Console screen type: `log com1 posa once`

After you hit the <Enter> key the ASCII Record screen will display the output for your current position. The POSA/B log is described on *Page 180*.

1.2 DATA LOGGING

The GPSCard has four major logging formats:

- NovAtel Format Data Logs (ASCII/Binary)
- NMEA Standard Format Data Logs (ASCII)
- RTCM Standard Format Data Logs (Binary)
- RTCA Standard Format Data Logs (Binary)

All data types can be logged using several methods of triggering each log event. Each log is initiated using the LOG command. The LOG command and syntax are listed following.

Syntax: log [port],datatype,[trigger],[period],[offset},{hold}

Syntax	Description	Example
LOG		LOG
port	COM1 or COM2 Defaults to the port that the command was entered on.	COM1
datatype	Enter one of the valid ASCII or Binary Data Logs (see <i>Chapter 4, Page 35</i> and <i>Appendix D, Page 138</i>)	POSA
trigger	Enter one of the following <i>triggers</i> . ONCE Immediately logs the selected data to the selected port once. Default if trigger field is left blank. ONMARK Logs the selected data when a MARKIN electrical event is detected. Outputs internal buffers at time of mark - does not extrapolate to mark time. Use MKPA/B for extrapolated position at time of mark. ONNEW Logs the selected data each time the data is new even if the data is unchanged. ONCHANGED Logs the selected data only when the data has changed. ONTIME <i>[period], [offset]</i> Immediately logs the selected data and then periodically logs the selected data at a frequency determined by the <i>period</i> and <i>offset</i> parameters. The logging will continue until an UNLOG command pertaining to the selected data item is received (see the <i>UNLOG</i> command, <i>Page 134</i>). CONTINUOUSLY Will log the data all the time. The GPSCard will generate a new log when the output buffer associated with the chosen port becomes empty. The <i>continuously</i> option was designed for use with differential corrections over low bit rate data links. This will provide optimal record generation rates. The next record will not be generated until the last byte of the previous record is loaded into the output buffer of the UART.	ONTIME
period	Use only with the <i>ONTIME</i> trigger. Units for this parameter are seconds. The selected period may be any of the following values: 0.05, 0.10, 0.20, 0.25, 0.50, 1, 2, 3, ... , 3600 seconds but may be limited by the GPSCard model and previously requested logs. Selected data is logged immediately and then periodic logging of the data will start at the next even multiple of the period. If a period of 0.20 sec is chosen, then data will be logged when the receiver time is at the 0.20, 0.40, 0.60 and the next (0.80) second marks. If the period is 15 seconds, then the logger will log the data when the receiver time is at even 1/4 minute marks. The same rule applies even if the chosen period is not divisible into its next second or minute marks. If a period of 7 seconds is chosen, then the logger will log at the multiples of 7 seconds less than 60, that is, 7, 14, 21, 28, 35, 42, 49, 56 and every 7 seconds thereafter.	60
offset	Use only with the <i>ONTIME</i> trigger. Units for this parameter are seconds. It provides the ability to offset the logging events from the above startup rule. If you wished to log data at 1 second after every minute you would set the period to 60 seconds and the offset to 1 second (Default is 0).	1
hold	Will prevent a log from being removed when the UNLOGALL command is issued	HOLD

NOTE: The syntax for a command can contain optional parameters (OPT1, OPT2, ...). OPT2 may only be used if it is preceded by OPT1. OPT3 may only be used if it is preceded by OPT2 and so on. Parameters after and including OPT1 will be surrounded by square brackets.

An optional parameter such as {hold} surrounded by braces may be used with the log command without any preceding optional parameters.

Example:

```
log com1 posa 60 1 hold
log com1 posa hold
```

Example:

```
log com1,posa,ontime,60,1
```

If the LOG syntax does not include a *trigger* type, it will be output only once following execution of the LOG command. If *trigger* type is specified in the LOG syntax, the log will continue to be output based on the *trigger* specification. Specific logs can be disabled using the UNLOG command, whereas all enabled logs will be disabled by using the UNLOGALL command (see *Chapter 2, Page 24* and *Appendix C, Page 81*). All activated logs will be listed in the receiver configuration status log (RCCA), *Page 192*.

The [port] parameter is optional. If [port] is not specified, [port] is defaulted to the port that the command was received on.

COMMONLY USED LOGS

Type	Logs	Trigger
Positioning	PRTKA/B POSA/B	ontime or onmark
Post Processing	RGEA/B/D REPA/B, ALMA/B	ontime onchanged
NMEA Position	GPGLL GPGGA	ontime or onmark

Other useful logs are

- RCCA to list the default command settings
- ETSA to monitor the channel tracking status
- SATA to observe the satellite specific data
- DOPA to monitor the dilution of precision of the current satellite constellation
- RVSA to monitor the receiver status

For further information on output logging see *Chapter 4, Page 35* and the individual logs listed alphabetically in *Appendix D, Page 138*.

Use the HELP command to list all available commands. For more information on sending commands see *Chapter 2, Page 24* and the individual commands listed alphabetically in *Appendix C, Page 81*.

1.3 DIFFERENTIAL OPERATION

The MiLLennium GPSCard is ideal for design into DGPS systems because it is capable of operating as either a reference station or a rover station.

The GPSCard is capable of utilizing various formats of differential corrections. These formats are divided into two primary groups RTCM and RTCA.

For detailed data structure concerning these logs, please see:

Chapter 3, Page 35

Chapter 4, Page 46

Appendix D, Page 138

Establish a Data Link

Operating the GPSCard with a DGPS system requires that the reference station broadcast differential correction data messages to one or more rover receivers. As there are many methods by which this can be achieved, it is up to you to establish an appropriate data link that best suits your user requirements.

Whatever data link is chosen, the operator of the reference station will want to ensure that the bit rate of data transmission is suitable for the anticipated data link and remote users. Use the GPSCard COMn command to the COM port default bit rate (default is 9600 bps, no parity, 8 data bits, 1 stop bit, no handshake, echo off).

Note that the GPSCard COMn_DTR and COMn_RTS commands are available for remote device keying (such as a radio transmitter). These commands allow for flexible control of the DTR and RTS lines to be precisely timed with log transmissions.

Further information may be found in *Appendix A*.

Table 1-1, following, is a GPSCard pseudorange differential initialization summary.

NOTE 1: Entry of the station ID and health are optional. For a CMR correction type the station ID must be ≤ 31 .

NOTE 2: The accuracy of the reference station's FIX POSITION setting will directly affect the accuracy of its computed differential corrections. Good results at the rover station are dependent on the reference station's combined position errors being kept to a minimum (e.g., fix position error + multipath errors).

NOTE 3: The GPSCard performs all computations based on WGS84 and is defaulted as such, regardless of DATUM command setting. The datum in which you choose to operate is converted from WGS84; therefore, all differential corrections are based on WGS84. Ensure that any change in your operating datum is set prior to FIX POSITION.

NOTE 4: When transmitting RTCM type data, the GPSCard has various options for assigning the number of data bits per byte. Please see the GPSCard command RTCMRULE, *Page 116* for further information concerning RTCM data bit rule settings.

NOTE 5: The FIX POSITION "health" field entered will be reported in word 2 of the RTCM message frame header.

Once the GPSCard has its position data fixed and is tracking three or more satellites, it is now ready to transmit differential correction and observation data to the rover stations.

LOG BROADCAST DATA

Assuming that a data link has been established, use the GPSCard log command to send observation and differential corrections data for broadcast to the rover stations.

Syntax:

```
LOG    
```

Example:

```
log com1 rtcml ontime 5
```

NOTE: Ensure that the bit rate of the data link is suitable for the differential type, logging rate and maximum message length of the data type being logged.

1.4 RTK MODE

NovAtel's RTK system utilizes proprietary messaging as well as RTCM Types 18 and 19, and can also receive CMR messages from a non-NovAtel base station. For more information on specific message formats please see *Chapter 4, Page 46*.

NOTE: No guarantee is made that the MiLLennium will meet its performance specifications if non-NovAtel accessories (e.g. antennas, RF cable) are used.

Data Communications Link

It is the user's responsibility to provide a data communications link between the reference station and remote station. The data transfer rate must be high enough to ensure that sufficient reference station messages reach the remote station to keep extrapolation errors from growing too large; see *Table 1-2*.

Table 1-2 Latency-Induced Extrapolation Error

Time since last reference station observation	Typical extrapolation error (CEP)
0-2 seconds	1 cm/sec
2-7 seconds	2 cm/sec
7-30 seconds	5 cm/sec

Generally, a communications link capable of data throughput at a rate of 4800 bits per second or higher is sufficient. However, it is possible to satisfactorily use a lower rate (e.g. 2400 bps) with the RTCA, RTCM59 and CMR formats. RTCM Types 18 and 19 may require a higher rate; see *Chapter 4, Message Formats, Page 46* for additional information. The minimum data transfer rate is based on the following:

1. RT-2 requires that the reference station periodically transmit two RTCA Standard Type 7 messages:

- An RTCAOBS message contains reference station satellite observation information, and should be sent once every 1 or 2 seconds.
- An RTCAREF message contains reference station position information, and should be sent once every 10 seconds.

OR periodically transmit an RTCM Type 18 and RTCM Type 19 (RTCM1819) message together with an RTCM Type 3 message:

- A Type 3 message contains reference station position information, and should be sent once every 10 seconds (although it is possible to send it as infrequently as once every 30 seconds).
- RTCM1819 gives raw measurement information (Type 18 provides carrier phase measurements, while Type 19 provides pseudorange measurements) and should be sent once every 1 or 2 seconds.

NOTE: This message can be sent in RTCM Version 2.1 or Version 2.2 format, controlled with the RTKMODE command.

and, optionally, also periodically transmit an RTCM Type 22 message together with an RTCM Type 3 message:

- A Type 3 message contains reference station position information, and should be sent once every 10 seconds (although it is possible to send it as infrequently as once every 30 seconds).
- A Type 22 message gives extended reference station parameters and should be sent once every 10 seconds.

OR periodically transmit two CMR messages where the station ID, see *Page 100*, must be ≤ 31 when transmitting CMR corrections:

- A CMROBS message contains reference station satellite observation information, and should be sent once every 1 or 2 seconds.
- A CMRREF message contains reference station position information, and should be sent once every 10 seconds.

2. RT-20 requires that the reference station periodically transmit either the RTCA messages listed above (the recommended option), or RTCM 1819 or CMR messages or the RTCM SC-104 Type 3 & 59N messages:

- A Type 3 message contains reference station position information, and should be sent once every 10 seconds (although it is possible to send it as infrequently as once every 30 seconds).
- A Type 59N message contains reference station satellite observation information, and should be sent once every 2 seconds.

Further information on RTCA, RTCM and CMR message formats is contained in *Chapter 6*.

System Initialization

The RTK system is designed for ease of use: you set up the remote station, enter a command so that it accepts RT-2 or RT-20 messages from the reference station, and are ready to go. There are options, however, which can be used to adapt the system to a specific application. Some options apply only to the reference station, while others

apply only to the remote station. Detailed descriptions can be found in *Appendix C, Commands Summary*.

In the following sections, keep the following in mind:

- Dynamics modes. For reliable performance the antenna should not move more than 1-2 cm when in static mode. See the RTKMODE commands in *Chapter 2, Page 24* and *Appendix C, Page 117* for more information.
- When using the FIX POSITION command, the height entered must be in metres above mean sea level; it will be converted to ellipsoidal height inside the receiver. You can enter an undulation value, if desired, using the UNDULATION command; if none is entered, the receiver estimates an undulation with its internal table. The format of the optional *station ID* field depends on whether RTCM or RTCA messages are being used: if RTCM, any number from 0 - 1023 is valid, while if RTCA, any 4-character string of numbers and upper-case letters, enclosed in quotation marks, is valid. See *Appendix C, Page 100* for additional information on the *station id* field.
- The *COMn* field refers to the serial port (either COM1 or COM2) to which data communications equipment is connected. The serial port assignment at the reference and remote stations need not be the same; e.g. a radio transmitter might be connected to COM1 at the reference station, and a radio receiver to COM2 at the remote station.

INITIALIZATION FOR RTCA-FORMAT MESSAGING (RT-2 OR RT-20)

The following commands will enable RTCA-format messaging and allow RT-2 or RT-20 to operate with the remote station either at rest or in motion. Note that the optional *station health* field in the existing FIX POSITION command is not currently implemented in NovAtel's RTCA messages, though it will be in the future.

1. At the reference station:

```
fix position lat,lon,height,station id
log comn,rtcaref,ontime,interval
log comn,rtcaobs,ontime,interval
```

Example:

```
fix position 51.11358042,-114.04358013,1059.4105,"RW34"
log com1,rtcaref,ontime,10
log com1,rtcaobs,ontime,2
```

2. At the remote station:

```
accept comn,rtca
```

Example:

```
accept com2,rtca
```

Congratulations! Your RTK system is now in operation!

INITIALIZATION FOR RTCM59-FORMAT MESSAGING (RT-20 ONLY)

Although RT-20 can operate with either RTCA or RTCM-format messaging, the use of RTCA-format messages is recommended (see *Chapter 4, Page 46* for further information on this topic). Nevertheless, the following commands will enable RTCM59-format messaging and allow RT-20 to operate with the remote station either at rest or in motion:

1. At the reference station:

```
fix position lat,lon,height,station id,station health
log comn,rtcm3,ontime,interval
log comn,rtcm59,ontime,interval
```

Example:

```
fix position 51.11358042,-114.04358013,1059.4105,119,0
log com1,rtcm3,ontime,10
log com1,rtcm59,ontime,2
```

2. At the remote station:

```
accept comn,rtcm
```

Example:

```
accept com2,rtcm
```

Congratulations! Your RT-20 system is now in operation!

Monitoring Your RTK Output Data

At the remote station, you could now select any or all of these output logs for positioning information:

- BSLA/B Baseline Measurement
- NMEA-format logs
- POSA/B Computed Position
- PRTKA/B Best Position
- RPSA/B Reference Station Position & Health
- RTKA/B RTK Output - Time Matched Positions

The POSA/B, PRTKA/B and NMEA-format logs contain the *low-latency* position; the RTKA/B logs contain the *matched* position. The low-latency solution is the recommended one for kinematic users, while the matched solution is the one recommended for stationary users. For a discussion on low-latency and matched positions, see the *Differential Positioning* section of *Appendix A, Page 67*.

Options for Logging Differential Corrections

SET DGPSTIMEOUT

The DGPSTIMEOUT command allows the reference station to set the delay by which it will inhibit utilization of new ephemeris data in its differential corrections. This delay ensures that the remote receivers have had sufficient time to collect updated ephemeris data as well.

A delay of 120 to 130 seconds will typically ensure that the rover stations have collected updated ephemeris. After the delay period is passed, the reference station will begin using new ephemeris data. To enter an ephemeris delay value, you must first enter a numeric placeholder in the DGPS delay field (e.g., 2). When operating as a reference station, DGPS delay will be ignored (see the DGPSTIMEOUT command found in *Chapter 2, Page 24* and *Appendix C, Page 92* for further information on using this command at rover stations.)

Syntax:

```
DGPSTIMEOUT  
```

Command	Option	Description	Default
DGPSTIMEOUT		Command	
dgps delay	min. 2 max. 1000	Maximum age in seconds	60
ephem delay	min. 0 max. 600	Minimum time delay in seconds	120

Example:

```
dgpstimeout 2,300
```

USING RTCM SC-104 LOG TYPES

RTCM SC-104 is a standard for transmitting differential corrections between equipment from different manufacturers. The NovAtel GPSCard is capable of transmitting or receiving RTCM data.

To facilitate transmitting the RTCM data over shared data links, the GPSCard is also capable of sending the RTCM log in NovAtel ASCII format (RTCMA) or with the NovAtel binary header (RTCMB) added to allow synchronous transmission and reception along with other data types.

NOTE: When sending or receiving RTCM log types, it is important to ensure that all connected equipment are using the same RTCMRULE for compatibility.

The easiest method to send RTCM standard logs is from the COM1 or COM2 ports of the reference GPSCard. The easiest method to receive the RTCM data is through the COM1 or COM2 port of the rover GPSCard. The rover GPSCard must issue the “ACCEPT port RTCM” command to dedicate a port before it will accept the RTCM data into that port.

The RTCMA log can be intermixed with other NovAtel ASCII data over a common communication port. It will be directly interpreted by a rover GPSCard as a special data input command (\$RTCM). “ACCEPT port COMMANDS” must be used with this input command. A non-NovAtel rover station will need to strip off the header (\$RTCM) and terminator (*xx), then convert the hexadecimal data to binary before the RTCM standard data can be retrieved.

The RTCMB log can be intermixed with other NovAtel binary data over a common communication port.

REMEMBER: Use the CDSA/B logs to monitor the COM port activity, success, and decoding errors.

USING RTCA LOG TYPES

The RTCA (Radio Technical Commission for Aviation Services) Standard is being designed to support Differential Global Navigation Satellite System (DGNSS) aviation applications. The perceived advantage to using RTCA type messages for transmitting and receiving differential corrections versus using RTCM type messages is that RTCM transmits 30-bit words, and the data is difficult to decode and process because of the parity algorithm and irregular word sizes used. RTCA is transmitted in 8-bit words, which are easier to generate, process and decode. The RTCA messages are therefore smaller, they have a 24 bit CRC that is much more robust than RTCM messages, and they permit the use of a four-alpha-character station ID.

RTCA standard logs can be received through the COM1 or COM2 port of the rover GPSCard. The remote GPSCard must issue the “ACCEPT port RTCA” command to dedicate a port before it will accept the RTCA data input to that port. The RTCA logs cannot be intermixed with other logs.

The RTCAA log can be intermixed with other NovAtel ASCII data over a common communications port. It will be directly interpreted by a rover GPSCard as a special data input command (\$RTCA). “ACCEPT port commands” must be used with this input command. A non-NovAtel rover station will need to strip off the header (\$RTCA) and terminator (*xx), then convert the hexadecimal data to binary before the RTCA standard can be retrieved.

The RTCAB log can be intermixed with other NovAtel binary data. The remote GPSCard identifies the RTCAB log by the message block identifier contained in the message, and will interpret only the RTCA data portion of the log.

NOTE: The CDSA/B logs may be used to monitor the COM port activity and differential data decode success.

Initialization - Rover Station

It is necessary to initialize the rover receiver to accept observation data from the reference station. If the receiver is not correctly initialized, it will proceed to compute solutions in single point positioning mode.

Before initializing, ensure that the data link with the reference station has been properly set up. As well, ensure that the COM port which is to receive the differential data is set up to match the bit rate and protocol settings of the reference station broadcast data.

Establishing differential mode of operation at the rover receiver is primarily a one-step process whereby the accept command is used to enable reception of observation data from the reference station.

ACCEPT COMMAND

The accept command is primarily used to set the GPSCard's COM port command interpreter for acceptance of various data formats (see the ACCEPT command in *Chapter 2, Page 24* and *Appendix C, Page 81*).

Syntax

```
ACCEPT  
```

Example:

```
accept com2 rtm
```

Once initialized, the rover GPSCard receiver will operate in single point mode until the differential messages are received. If the data messages are lost, the GPSCard will revert to single point positioning until the pseudorange correction messages are restored.

NOTE: Ensure that the GPSCard RTCMRULE settings agree with the bit rule being transmitted by the RTCM reference station. Unless otherwise set, all GPSCards default to 6CR.

LOG POSITION DATA AND OTHER USEFUL DATA

The GPSCard remote receiver has many options for information data logging. To monitor position status, the user may find the PRTKA/B logs to be the most informative. Other options exist, such as POSA/B and GPGGA. As well, velocity data can be found in the VLHA/B, SPHA/B and GPVTG logs. It is really up to your specific applications as to the full range of logs you require.

2 COMMAND DESCRIPTIONS

2.1 GENERAL

This section describes all commands accepted by the GPSCard with the exception of the "Special Data Input Commands". They are listed in alphabetical order. For descriptions of output logs using the LOG command, see Chapter 3.

The GPSCard is capable of responding to over 50 different input commands. You will find that once you become familiar with these commands, the GPSCard offers a wide range in operational flexibility. All commands are accepted through the COM1 and COM2 serial ports. See Table 2-1, Page 26 for a complete command listing.

NOTE: You will find the HELP command a useful tool for inquiring about the various commands available.

The following rules apply when entering commands from a terminal keyboard:

- The commands are not case sensitive (*COMMAND* or *command*).

e.g. *HELP* or *help*

e.g. *FIX POSITION* or *fix position*

- All commands and required entries can be separated by a space or a comma (*command,variable* OR *command variable*).

e.g. *datum,tokyo*

e.g. *datum tokyo*

e.g. *fix,position,51.3455323,-117.289534,1002*

e.g. *fix position 51.3455323 -117.289534 1002*

e.g. *com1,9600,n,8,1,n,off*

e.g. *com1 9600 n 8 1 n off*

e.g. *log,com1,posa,unchanged*

e.g. *log com1 posa unchanged*

- At the end of a command or command string, press the <CR> key. A carriage return is what the card is looking for and is usually the same as pressing the <Enter> key.
- Most command entries do not provide a response to the entered command. Exceptions to this statement are the VERSION and HELP commands. Otherwise, successful entry of a command is verified by receipt of the COM port prompt (i.e. COM1> or COM2>).

The syntax for a command can contain optional parameters (OPT1, OPT2, ...). OPT2 may only be used if it is preceded by OPT1. OPT3 may only be used if it is preceded by OPT2 and so on. Parameters after and including OPT1 will be surrounded by square brackets.

An optional parameter such as {hold} surrounded by braces may be used with the log without any preceding optional parameters

Example:

```
log com1 posa 60 1 hold
```

```
log com1 posa hold
```

When the GPSCard is first powered up, or after a FRESET command, all commands will revert to the factory default settings. An example is shown below. The SAVECONFIG command can be used to modify the power-on defaults. Use the RCCA log to reference station command and log settings.

NOTE: All previously stored configurations that were saved to non-volatile memory are erased (including Saved Config, Saved Almanac, and Channel Config).

Example:

```
$RCCA,COM1,57600,N,8,1,N,OFF,ON*10
$RCCA,COM1_DTR,HIGH*70
$RCCA,COM1_RTS,HIGH*67
$RCCA,ACCEPT,COM1,COMMANDS*5B
$RCCA,COM2,9600,N,8,1,N,OFF,ON*28
$RCCA,COM2_DTR,HIGH*73
$RCCA,COM2_RTS,HIGH*64
$RCCA,ACCEPT,COM2,COMMANDS*58
$RCCA,UNDULATION,TABLE*56
$RCCA,DATUM,WGS84*15
$RCCA,USERDATUM,6378137.000,298.257223563,0.000,0.000,0.000,0.000,0.000,0.000*6A
$RCCA,SETNAV,DISABLE*5C
$RCCA,MAGVAR,0.000,30.000*02
$RCCA,DYNAMICS,AIR*4F
$RCCA,UNASSIGNALL*64
$RCCA,UNLOCKOUTALL*20
$RCCA,RESETHEALTHALL*37
$RCCA,UNFIX*73
$RCCA,ANTENNAPOWER ON*1E
$RCCA,SETDGPSID,ALL*1D
$RCCA,RTCMRULE,6CR*32
$RCCA,RTCM16T,*48
$RCCA,CSMOOTH,20.00,20.00*7E
$RCCA,ECUTOFF,0.00*45
$RCCA,FREQUENCY_OUT,DISABLE*12
$RCCA,EXTERNALCLOCK,DISABLE*12
$RCCA,CLOCKADJUST,ENABLE*47
$RCCA,SETTIMESYNC,DISABLE*17
$RCCA,SETL1OFFSET,0.000000*3F
$RCCA,MESSAGES,ALL,ON*67
$RCCA,DGPSTIMEOUT,60.00,120.00*51
$RCCA,SAVEALMA,ONNEW*4E
$RCCA,POSAVE,DISABLE*59
$RCCA,RTKMODE,DEFAULT*16
$RCCA,CONFIG,STANDARD*02
$RCCA,DIFF_PROTOCOL,DISABLED*47
$RCCA,IONOMODEL,CALCULATED*5B
$RCCA,WAASCORRECTION,DISABLE*55
$RCCA,LOG,COM1,PRTKB,ONTIME,10.00*6F
$RCCA,LOG,COM1,MKPB,ONNEW*6E
$RCCA,LOG,COM1,POSB,ONTIME,1.00*0E
$RCCA,LOG,COM1,TM1B,ONTIME,30.00*58
```

Optional Calculation Of The Checksum

When an input command is followed by an optional checksum, the checksum will be verified before the command is executed. The checksum is the result of the logical exclusive-OR operation on all the bits in the message. So, the checksum of a command with parameters will change if the parameters are modified.

NOTE: The command must be typed in uppercase for the proper checksum to be calculated.

As an example, it may be essential to ensure that a receiver has received and executed the correct command from a host computer. If the checksum were calculated by the sender and attached to the command, the receiver would be able to recognize if errors had been introduced and if so, alert the sender to this with an “Invalid Command CRC” message.

Example:

```
FIX HEIGHT 4.567[CR][LF]
FIX HEIGHT 4.567*66[CR][LF]
```

Both are acceptable, but only the second one would trigger the verification function.

2.2 STANDARD COMMAND TABLES

Table 2-1 lists the commands by function while Table 2-2 is an alphabetical listing of commands. Please see Appendix C, Page 81 for a more detailed description of individual commands which are listed alphabetically.

Table 2-1 Commands By Function Table

COMMUNICATIONS, CONTROL AND STATUS	
Commands	Descriptions
ANTENNAPOWER	Power to the low-noise amplifier of an active antenna
COMn	COMn port configuration control
COMn_DTR	DTR handshaking control
COMn_RTS	RTS handshaking control
DIFF_PROTOCOL ¹	Differential Protocol Control
FREQUENCY_OUT	Variable frequency output (programmable)
LOG	Logging control
MESSAGES	Disable error reporting from command interpreter
RINEX	Configure the user defined fields in the file header
RTCMRULE	Sets up RTCM bit rule
RTCM16T	Enters an ASCII message
SEND	Sends ASCII message to COM port
SENDHEX	Sends non-printable characters
SETL1OFFSET ¹	Add an offset to the L1 pseudorange to compensate for signal delays

¹ Intended for advanced users of GPS only

GENERAL RECEIVER CONTROL AND STATUS	
Commands	Descriptions
\$ALMA	Download almanac data file
CRESET	Reset receiver to factory default
DYNAMICS	Set correlator tracking bandwidth
HELP	On-line command help
RESET	Performs a hardware reset (OEM only)
SAVEALMA	Saves the latest almanac in NVM
SAVECONFIG	Saves current configuration (OEM only)
\$TM1A	Injects receiver time of 1PPS
VERSION	Software/hardware information

Table 2-1 Commands By Function Table (continued)

POSITION, PARAMETERS, AND SOLUTION FILTERING CONTROL	
Commands	Descriptions
CSMOOTH ¹	Sets amount of carrier smoothing
DATUM	Choose a DATUM name type
ECUTOFF	Satellite elevation cut-off for solutions
FIX HEIGHT	Constrains to fixed height (2D mode)
FIX POSITION	Constrains to fixed lat, lon, height
FRESET	Clears all data which is stored in NVM
\$IONA	Download ionospheric correction data
IONOMODEL	What ionospheric correction to use (MiLLennium with the WAAS option)
LOCKOUT	Deweights a satellite in solutions
\$PVAA ¹	Position, velocity and acceleration in ECEF coordinates
RTKMODE	Setup the RTK mode
UNDULATION	Ellipsoid-geoid separation
USERDATUM	User-customized datum
WAASCORRECTION	Controls handling of WAAS/EGNOS corrections.

¹ Intended for advanced users of GPS only.

SATELLITE TRACKING AND CHANNEL CONTROL	
Commands	Descriptions
\$ALMA	Download almanac data file
ASSIGN	Satellite channel assignment
CONFIG	Switches the channel configuration of the GPSCard
DYNAMICS	Sets correlator tracking bandwidth
FIX VELOCITY	Aids high velocity reacquisition
RESETHEALTH	Reset PRN health
SETHEALTH	Overrides broadcast satellite health

WAYPOINT NAVIGATION	
Commands	Descriptions
MAGVAR	Magnetic variation correction
SETNAV	Waypoint input

DIFFERENTIAL REFERENCE STATION	
Commands	Descriptions
DGPSTIMEOUT	Sets ephemeris delay
FIX POSITION	Constrain to fixed (reference)
LOG	Selects required differential-output log
POSAVE	Implements position averaging for reference station
RTCMRULE	Selects RTCM bit rule
SETDGPSID	Set reference station ID

Table 2-1 Commands By Function Table (continued)

DIFFERENTIAL REMOTE STATION	
Commands	Descriptions
ACCEPT	Accepts RTCM1, RTCA or RTCAB differential inputs
\$ALMA	Input almanac data
DGPSTIMEOUT	Set maximum age of differential data accepted
RESET	Performs a hardware reset
\$RTCA	RTCA differential correction input (ASCII)
\$RTCM	RTCM differential correction input (ASCII)
RTCMRULE	Selects RTCM bit rule
SETDGPSID	Select differential reference station ID to receive

CLOCK INFORMATION, STATUS, AND TIME	
Commands	Descriptions
CLOCKADJUST	Enable clock modelling & 1PPS adjust
DIFF_PROTOCOL ¹	Differential protocol control
EXTERNALCLOCK	Sets default parameters of an optional external oscillator
EXTERNALCLOCK FREQUENCY	Sets clock rate
SETTIMESYNC ¹	Enable or disable time synchronization
\$UTCA	Download UTC data

1 Intended for advanced users of GPS only

Table 2-2 GPSCard Command Summary

Command	Description	Syntax
\$ALMA	Injects almanac	(follows NovAtel ASCII log format)
\$IONA	Injects ionospheric refraction corrections	(follows NovAtel ASCII log format)
\$PVAA	Injects latest computed position, velocity and acceleration	(follows NovAtel ASCII log format)
\$REPA	Injects raw GPS ephemeris data	(follows NovAtel ASCII log format)
\$RTCA	Injects RTCA format DGPS corrections in ASCII (Type 1)	(follows NovAtel ASCII log format)
\$RTCM	Injects RTCM format differential corrections in ASCII (Type 1)	(follows NovAtel ASCII log format)
\$TM1A	Injects receiver time of 1 PPS	(follows NovAtel ASCII log format)
\$UTCA	Injects UTC information	(follows NovAtel ASCII log format)
ACCEPT	Port input control (set command interpreter)	accept <i>port,option</i>
ANTENNAPOWER	Power to the low-noise amplifier of an active antenna	antennapower <i>flag</i>
ASSIGN	Assign a prn to a channel #	assign <i>channel,prn,doppler, search window</i>
UNASSIGN	Un-assign a channel	unassign <i>channel</i>
UNASSIGNALL	Un-assign all channels	unassignall
CLOCKADJUST	Disable clock steering mechanism	clockadjust <i>switch</i>
COMn	Initialize Serial Port (1 or 2)	comn <i>bps,parity,databits,stopbits, handshake,echo</i>
COMn_DTR	Programmable DTR lead/tail time	comn_dtr <i>control,active,lead,tail</i>
COMn_RTS	Programmable RTS lead/tail time	comn_rts <i>control,active,lead,tail</i>
CONFIG	Switches the channel configuration of the GPSCard	config <i>cfgtype</i>
CRESET	Configuration reset to factory default	creset
CSMOOTH	Sets carrier smoothing	csmooth <i>value</i>
DATUM	Choose a DATUM name type	datum <i>option</i>
USERDATUM	User defined DATUM	userdatum <i>semi-major,flattening,dx,dy,dz, rx,ry,rz, scale</i>
DGPSTIMEOUT	Sets maximum age of differential data to be accepted and ephemeris delay	dgpstimeout <i>value value</i>

DIFF_PROTOCOL	Differential correction message encoding and decoding for implementation in the GPS card firmware	diff_protocol <i>type key</i> or diff_protocol <i>disable</i> or diff_protocol
DYNAMICS	Set receiver dynamics	dynamics <i>option [user_dynamics]</i>
ECUTOFF	Set elevation cutoff angle	ecutoff <i>angle</i>
EXTERNALCLOCK	Sets default parameters of an optional external oscillator	externalclock <i>option</i>
EXTERNALCLOCK FREQUENCY	Sets clock rate	external frequency <i>clock rate</i>
FIX HEIGHT	Sets height for 2D navigation	fix height <i>height [auto]</i>
FIX POSITION	Set antenna coordinates for reference station	fix position <i>lat,lon,height [station id] [health]</i>
FIX VELOCITY	Accepts INS xyz (ECEF) input to aid in high velocity reacquisition of SVs	fix velocity <i>vx,vy,vz</i>
UNFIX	Remove all receiver FIX constraints	unfix
FREQUENCY_OUT	Variable frequency output (programmable)	frequency_out <i>n,k</i>
FRESET	Clears all data which is stored in non-volatile memory	freset
HELP or ?	On-line command help	help <i>option</i> or ? <i>option</i>
IONOMODEL	Influences what ionospheric corrections the card uses	ionomodel <i>keyword</i>
LOCKOUT	Lock out satellite	lockout <i>prn</i>
UNLOCKOUT	Restore satellite	unlockout <i>prn</i>
UNLOCKOUTALL	Restore all satellites	unlockoutall
LOG	Choose data logging type	log <i>[port],datatype,[trigger],[period],[offset],[hold]</i>
UNLOG	Disable a data log	unlog <i>[port],data type</i>
UNLOGALL	Disable all data logs	unlogall <i>[port]</i>
MAGVAR	Set magnetic variation correction	magvar <i>value</i>
MESSAGES	Disable error reporting from command interpreter	messages <i>port,option</i>
POSAVE	Implements position averaging for reference station	posave <i>maxtime, maxhorstd, maxverstd</i>
RESET	Performs a hardware reset (OEM only)	reset
RINEX	Configure the user defined fields in the file headers	rinex <i>cfgtype</i>
RTCM16T	Enter an ASCII text message to be sent out in the RTCM data stream	rtcm16t <i>ascii message</i>
RTCMRULE	Set variations of the RTCM bit rule	rtcmrule <i>rule</i>
RTKMODE	Set up the RTK mode	rtkmode <i>argument, data range</i>
SAVEALMA	Save the latest almanac in non-volatile memory	savealma <i>option</i>
SAVECONFIG	Save current configuration in non-volatile memory (OEM only)	saveconfig
SEND	Send an ASCII message to any of the communications ports	send <i>port ascii-message</i>
SENDHEX	Sends non-printable characters in hexadecimal pairs	sendhex <i>port data</i>
SETDGPSID	Enter in a reference station ID	setdgpsid <i>option</i>
SETHEALTH	Override PRN health	sethealth <i>prn,health</i>
RESETHEALTH	Reset PRN health	resethealth <i>prn</i>
RESETHEALTHALL	Reset all PRN health	resethealthall
SETL1OFFSET	Add an offset to the L1 pseudorange to compensate for signal delays	setL1offset <i>distance</i>
SETNAV	Set a destination waypoint	setnav <i>from lat,from lon,to lat, to lon,track offset, from port,to port</i>
SETTIMESYNC	Enable or disable time synchronization	settimesync <i>flag</i>
UNDULATION	Choose undulation	undulation <i>separation</i>
VERSION	Current software and hardware information	version
WAASCORRECTION	Dictates how the card handles WAAS/EGNOS corrections	waascorrection <i>keyword [prn] [mode]</i>

2.3 WAAS

The Wide Area Augmentation System (WAAS) is a safety-critical system that provides a quality of positioning information previously unavailable. The WAAS improves the accuracy, integrity, and availability of the basic GPS signals. In the future, the wide area of coverage for this system will include the entire United States and some outlying areas. At the time of publication, there are two WAAS satellites over the western Atlantic Ocean and the Pacific (PRN 122 and PRN 134 respectively) and one EGNOS satellite over the eastern Atlantic Ocean (PRN 120). WAAS data is available from any of these satellites and more satellites will be available in the future.

The primary functions of WAAS include:

- data collection
- determining ionospheric corrections
- determining satellite orbits
- determining satellite clock corrections
- determining satellite integrity
- independent data verification
- WAAS message broadcast and ranging
- system operations & maintenance

As shown in *Figure 2-1*, the WAAS is made up of a series of Wide Area Reference Stations, Wide Area Master Stations, Ground Uplink Stations and Geostationary Satellites (GEOs). The Wide Area Reference Stations, which are geographically distributed, pick up GPS satellite data and route it to the Wide Area Master Stations where wide area corrections are generated. These corrections are sent to the Ground Uplink Stations which up-link them to the GEOs for re-transmission on the GPS L1 frequency. These GEOs transmit signals which carry accuracy and integrity messages, and which also provide additional ranging signals for added availability, continuity and accuracy. These GEO signals are available over a wide area and can be received and processed by ordinary GPS receivers. GPS user receivers are thus able to receive WAAS data in-band and use not only differential corrections, but also integrity, residual errors and ionospheric information for each monitored satellite.

Figure 2-1 The WAAS Concept

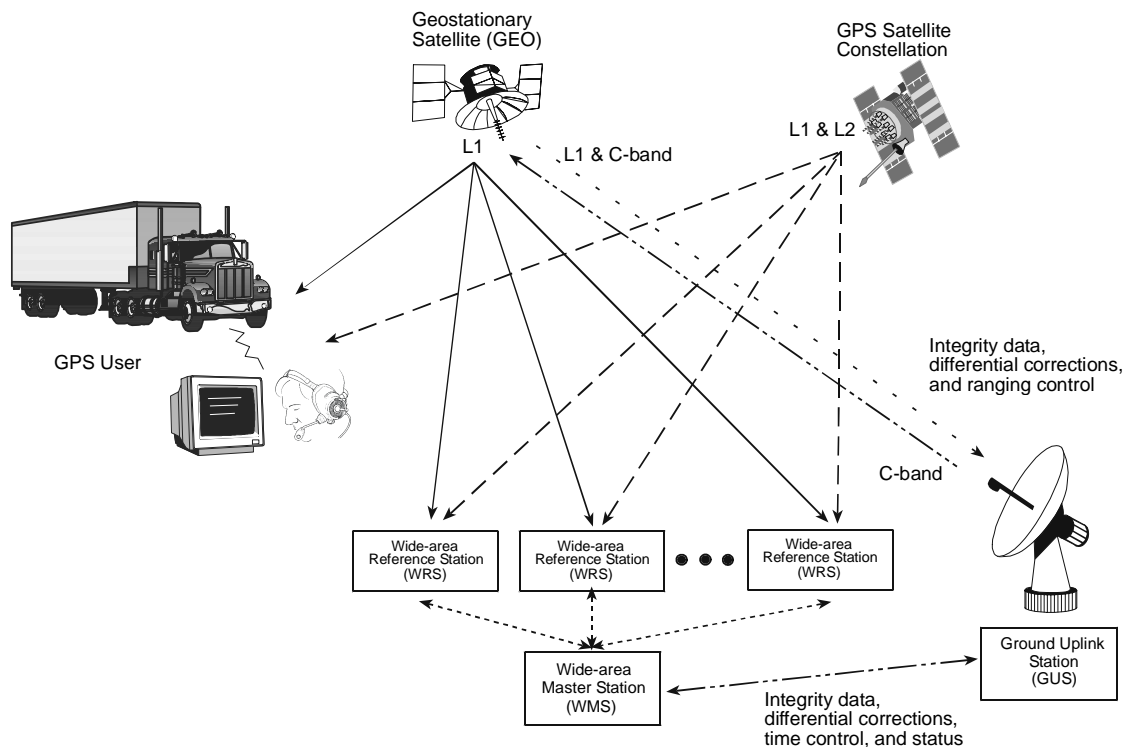

The signal broadcast via the WAAS GEOs to the WAAS users is designed to minimize modifications to standard GPS receivers. As such, the GPS L1 frequency (1575.42 MHz) is used, together with GPS-type modulation - e.g. a Coarse/Acquisition (C/A) pseudorandom (PRN) code. In addition, the code phase timing is maintained close to GPS time to provide a ranging capability.

2.3.1 WAAS GPSCard

The MILLEN-STDW, MILLEN-3111W and MILLEN-3151W models of the MiLlennium GPSCard are equipped with the WAAS/EGNOS option. The ability to incorporate the WAAS/EGNOS corrections into the position is the default mode for these models.

NovAtel has developed several models of WAAS-capable MiLlennium GPSCards that process WAAS signals. These models can output the WAAS data in log format (FRMA/B, WALA/B), and can incorporate these corrections to generate differential-quality position solutions. The WAAS/EGNOS models permit two user-configurable options: 12 GPS (10 Hz position and raw data output rate) or 10 GPS and 1 WAAS L1 channels (2 Hz output). The second configuration is the default for WAAS/EGNOS models. The first is invoked with the CONFIG command (see *Page 88*) and resets the card. Standard WAAS/EGNOS data messages are analyzed based on RTCA standard DO-229B Change 1 Minimum Operational Performance Standards for GPS/WAAS airborne equipment.

A WAAS/EGNOS-capable MiLlennium GPSCard will permit anyone within the area of coverage to take advantage of its benefits. In addition, it has all the features of a standard MiLlennium GPSCard.

WAAS COMMANDS

Two commands, WAASCORRECTION and IONOMODEL (see their descriptions on *Page 137* and *Page 105* respectively), enable the use of the WAAS corrections in the position filter. In order to use these commands, first ensure that your GPSCard is capable of receiving WAAS corrections.

2.4 SPECIAL DATA INPUT COMMANDS

These entries are data messages that are generated by one GPSCard and sent to another. For example, consider a special configuration in which a GPSCard #1 is able to send these data messages to a GPSCard #2 via a serial port. For GPSCard #1, this is no different than sending these data messages to a file or a screen. Each of these data messages has a special header which is interpreted by GPSCard #2 to mean that the data in that message is to be used as an update of its own GPS parameters such as time, position, velocity, acceleration or knowledge of satellite ephemeris.

In this general category also belong the RTCM data messages (\$RTCM1A, \$RTCM3A, \$RTCM9A, \$RTCM16A, and \$RTCM59A). These are described in further detail in *Chapter 4, Message Formats*.

The injection of special command data can take place via COM1 or COM2. Remember, the source of these special data commands are valid NovAtel ASCII data logs.

The special data commands fall into two categories: **Almanac Data** and **Differential Corrections**.

2.4.1 Almanac Data

The GPSCard's standard features include almanac data collection. Following a cold-start boot-up or system reset, the GPSCard will begin a sky search. Once a valid satellite is acquired, the GPSCard will begin almanac downloading and decoding. This process will take at least 12.5 minutes following the cold-start (assuming there are no problems with satellite visibility or the antenna system). It is noted that Ionospheric Correction Data and UTC data are also collected at the same time as almanac data and will also be available following the 12.5 minutes collection period mentioned above.

12 channel OEM cards with the SAVECONFIG option will automatically save almanacs in their non-volatile memory. They will also automatically load the last saved almanac following a cold start or a reset. The card will save an almanac and ionospheric and UTC data received from a satellite if there is no current data in non-volatile memory (NVM), or if the GPS week number of the received data is newer than the week number of the data in NVM. The save will not occur until between 12.5 and 25 minutes have elapsed since the last reset. To check if almanac data is saved in the NVM of the OEM card, check the "almanac data saved" bit in the receiver status word. See the description of the RCSA/B logs, *Appendix D, Page 193* for details.

The GPSCard is capable of logging almanac data utilizing the NovAtel-format ASCII log command option ALMA. Once logged, the data records will precede the header with the \$ character (e.g., \$ALMA).

There are no specific NovAtel log option commands to independently specify output of ionospheric or UTC parameters. These parameters will always output following the \$ALMA log (identifiable by the headers \$IONA and \$UTCA respectively). See *Chapter 3* and *Appendix D, Page 138* for more information on the ALMA output log command option.

The GPSCard has the capability to accept injection of previously logged NovAtel-format ASCII almanac data (\$ALMA, \$IONA, and \$UTCA). The GPSCard will interpret this log data as special data input commands. This provides the user with the advantage of being able to inject recent almanac data following a cold-start or RESET without having to wait the 12.5 minutes described in above paragraphs.

There are various ways by which this can be accomplished.

- By connecting the COM1 or COM2 port from one GPSCard (reference) directly to the COM1 or COM2 port of another GPSCard (remote). The reference card is assumed to be tracking satellites for some time and can be commanded by the ALMA log command option to output almanac records to the remote card. The remote card can be assumed to be just powered-up or RESET and will recognize the \$ALMA, \$IONA, and \$UTCA data as special input commands and update its almanac tables with this new data.

NOTE: When connecting two GPSCard COM ports together, the MESSAGES command option should be set to "OFF" to prevent inter-card "chatter".

- The MiLLEnnium GPSCard can log current almanac data to a PC connected to its COM1 or COM2 port. Assuming the PC is correctly configured using terminal emulator communications software, then the PC can redirect the GPSCard almanac log to its disk storage device. At a later time following a system restart, the GPSCard can have this almanac.dat file (containing \$ALMA, \$IONA, and \$UTCA records) immediately downloaded as a special input command for immediate use. Refer to the *MiLLEnnium GPSCard Guide to Installation and Operating* manual for more information about interfacing with the OEM card with a PC. [Note: this procedure will generally not be required with OEM cards as all 12 channel cards now have an almanac save feature built in using non-volatile memory.]

\$ALMA...

Use this special data input command to quickly update the GPSCard almanac tables following a system restart. It is generated from a GPSCard ALMA log and is accepted as the following format:

```
$ALMA,1,3.55148E-003,552960,744,-7.8174E-009,6.10457691E-002,-1.1820041E+000,
1.90436112E+000,-1.8119E-005,-3.6379E-012,1.45854758E-004,2.65602532E+007,
9.55600E-001,1,0,0*0C
...
(one record for each valid satellite)
...
$ALMA,31,4.90379E-003,552960,744,-7.9660E-009,-3.1044479E+000,6.13853346E-001,
1.92552900E+000,6.67572E-006,3.63797E-012,1.45861764E-004,2.65594027E+007,
9.61670E-001,1,0,0*3F
```

\$IONA...

Use this special data input command to quickly update the GPSCard ionospheric corrections tables following a system restart (always appended to \$ALMA records unless intentionally stripped). This data will ensure that the initial position solutions computed by the GPSCard are as accurate as possible. It is generated from a GPSCard ALMA log and is accepted by any GPSCard as the following format:

```
$IONA,1.0244548320770265E-008,1.4901161193847656E-008,-5.960464477539061E-008,
-1.192092895507812E-007,8.806400000000017E+004,3.276800000000010E+004, -
1.966080000000001E+005,-1.966080000000001E+005*02
```

\$UTCA...

Use this special data input command to quickly update the GPSCard Universal Time Coordinated (UTC) parameters following a system restart (always appended to \$ALMA records unless intentionally stripped). The UTC data is required before the GPSCard can accurately compute UTC time. If not input with \$UTCA, it may take up to 12.5 minutes after a reset for the GPSCard to receive current UTCA data. In order to comply with NMEA standards, the GPSCard will null NMEA log data fields until valid UTC parameters are collected or injected by the \$UTCA input command. This command is generated from a GPSCard ALMA log and is accepted as the following format:

```
$UTCA,-1.769512891769409E-008,-1.776356839400250E-015,552960,744,755,9,10,5*03
```

2.4.2 Differential Corrections Data

NovAtel MiLLennium cards can utilize the special data input commands \$RTCA and \$RTCM. These special data input commands are utilized by a GPSCard operating as a remote station to accept NovAtel ASCII format differential corrections. The data is generated by a GPSCard operating as a reference station with intent to be received by remote stations. To correctly interpret these commands, the remote GPSCard must have its ACCEPT command option set to "COMMANDS" (default). See *Appendix A, Page 67* for further information on differential positioning.

\$PVAA/B XYZ POSITION, VELOCITY AND ACCELERATION

The \$PVAA and PVAB data messages contain the receiver's latest computed position, velocity and acceleration. These quantities are in rectangular ECEF coordinates based on the centre of the WGS-84 ellipsoid.

When a GPSCard receives this data message, it uses the information to update its own position, velocity and acceleration parameters. This would only be needed if the GPSCard could not compute its own position, velocity and acceleration due to signal blockage. This data message helps the receiver reacquire satellites after loss of lock. The data would aid the receiver channels in the re-acquisition process; thus, the receiver would "follow" the blocked satellites and re-acquire them much more quickly when they become visible again.

The position, velocity and acceleration status fields indicate whether or not the corresponding data are valid. Only those messages containing valid data are used by the GPSCard.

NOTE 1: This command is intended for applications involving very high dynamics - where significant position, velocity and acceleration changes can occur during a signal blockage. This data message helps the receiver reacquire satellites after loss of lock.

NOTE 2: This is a highly complex function, to be used only by advanced users.

The ASCII \$PVAA data message is generated from a PVAA log, and the binary PVAB data message is generated from a PVAB log. For descriptions of these data messages, please see the description of the PVAA/B logs in *Chapter 4, Page 35* and *Appendix D, Page 183*. An example of a \$PVAA data message is as follows:

```
$PVAA,845,344559.00,-1634953.141,-3664681.855,4942249.361,-0.025,0.140,  
0.078,0.000,-0.000,0.000,1,1,1*02
```

\$REPA/B RAW GPS EPHEMERIS DATA

In cases where the receiver does not have an ephemeris for a newly-viewed satellite, these data messages can be used to reduce the time required to incorporate this satellite into the position solution

The \$REPA and REPB data messages contain the raw binary information for subframes one, two and three from the satellite with the parity information removed. Each subframe is 240 bits long (10 words - 25 bits each) and the log contains a total 720 bits (90 bytes) of information (240 bits x 3 subframes). This information is preceded by the PRN number of the satellite from which it originated. This message will not be generated unless all 10 words from all 3 frames have passed parity.

The ASCII \$REPA data message is generated from a REPA log, and the binary REPB data message is generated from a REPB log. For descriptions of these data messages, please see the description of the REPA/B logs in

Chapter 3 and Appendix D, Page 194. An example of a \$REPA data message is as follows:

```
$REPA,14,8B09DC17B9079DD7007D5DE404A9B2D04CF671C6036612560000021804FD,
8B09DC17B98A66FF713092F12B359DF7A0254088E1656A10BE2FF125655,
8B09DC17B78F0027192056EAFDF2724C9FE159675A8B468FFA8D066F743*57[CR][LF]
```

\$RTCA... (RTCAA)

Use this special data input command to directly input NovAtel RTCAA differential corrections data, ASCII format. The data can be accepted using COM1 or COM2. The differential corrections will be accepted and applied upon receipt of this special data input command.

The data is generated from a GPSCard RTCAA log and is accepted by a GPSCard remote station as in the following format:

```
$RTCA,990000000447520607BE7C92FA0B82423E9FE507DF5F3FC9FD071AFC7FA0D207D090808C0E
045BACC055E9075271FFB0200413F43FF810049C9DFF8FFD074FCF3C940504052DFB*20
```

\$RTCM...(RTCMA,\$RTCM1A,\$RTCM3A,\$RTCM9A,\$RTCM16A,\$RTCM59A)

Use this special data input command to directly input RTCMA differential correction data, ASCII format (RTCM data converted to ASCII hexadecimal, with NovAtel header added). The data can be accepted using COM1 or COM2. The differential corrections will be accepted and applied upon receipt of this special data input command. See *RTCA Standard Logs on Page 47* for further information on RTCM related topics.

The data is generated from a GPSCard RTCMA log and is accepted by a GPSCard remote station as in the following format

```
$RTCM,664142404E7257585C6E7F424E757D7A467C47414F6378635552427F73577261624278777F
5B5A525C7354527C4060777B4843637C7F555F6A784155597D7F6763507B77496E7F7A6A426F555C
4C604F4E7F467F5A787F6B5F69506C6D6A4C*2B
```

NOTE: The \$RTCAA and \$RTCMA commands allow the user to intermix differential corrections along with other ASCII commands or logs over a single port. (You must, however, ensure that the ACCEPT command option is set to "COMMANDS".)

TIP: The decoding success and status of \$RTCA and \$RTCM records can be monitored using the CDSA/B data log. These commands will not generate any reply response from the command interpreter. They will simply be processed for valid format and checksum and used internally. If there is any problem with the data, characters missing or checksum fail, the data will be discarded with no warning message.

\$TM1A/B RECEIVER TIME OF 1PPS

The \$TM1A and TM1B data messages can be used to time-synchronize multiple receivers which are all referencing the same external oscillator. First, ensure that SETTIMESYNC is enabled. Next, the primary unit must be sending its 1PPS signal to the MARKIN input of the secondary unit. Third, the two units must be communicating via a COM port. In this configuration, the user can send the \$TM1A log from a primary to a secondary unit, in a manner similar to that for \$ALMA or \$UTCA. The secondary unit is then able to compare the time information contained in the log with that of the 1PPS signal, and set its clock even though it may not be tracking any satellites.

The ASCII \$TM1A data message is generated from a TM1A log, and the binary TM1B data message is generated from a TM1B log. For descriptions of these data messages, please see the description of the TM1A/B logs in *Chapter 4, Page 35* and *Appendix D, Page 220*. An example of a \$TM1A data message is as follows:

```
$TM1A,794,414634.999999966,-0.000000078,0.000000021,-.999999998,0*57[CR][LF]
```

The \$TM1A/B message refers to the 1PPS pulse which has just occurred. In other words TM1A comes after a 1PPS pulse. The length of the pulse for the 24 channel L1/L2 MiLLennium GPSCard is a normally high, active low pulse (1 millisecond), where falling edge is reference.

3 DATA LOGS

3.1 OUTPUT LOGGING

The GPSCard provides versatility in your logging requirements. You can direct your logs to either COM1 or COM2, or both ports, as well as combine data types. The GPSCard has four major logging formats:

- NovAtel Format Data Logs (ASCII/Binary)
- NMEA Standard Format Data Logs (ASCII)
- RTCM Standard Format Data Logs (Binary)
- RTCA Standard Format Data Logs (Binary)

All data types can be logged using several methods of triggering each log event. Each log is initiated using the LOG command. The LOG command and syntax are listed below.

Syntax:

```
log [port],datatype,[trigger],[period],[offset},{hold}
```

Syntax	Description	Example
LOG		LOG
port	COM1 or COM2	COM1
datatype	Enter one of the valid ASCII or Binary Data Logs (see later in this chapter and <i>Appendix D, Page 138</i>)	POSA
trigger	Enter one of the following <i>triggers</i> . ONCE Immediately logs the selected data to the selected port once. Default if trigger field is left blank. ONMARK Logs the selected data when a MARKIN electrical event is detected. Outputs internal buffers at time of mark - does not extrapolate to mark time. Use MKBA/B for extrapolated position at time of mark. ONNEW Logs the selected data each time the data is new even if the data is unchanged. ONCHANGED Logs the selected data only when the data has changed. ONTIME [period], [offset] Immediately logs the selected data and then periodically logs the selected data at a frequency determined by the <i>period</i> and <i>offset</i> parameters. The logging will continue until an UNLOG command pertaining to the selected data item is received (see <i>UNLOG Command, Page 134</i>). CONTINUOUSLY Will log the data all the time. The GPSCard will generate a new log when the output buffer associated with the chosen port becomes empty. The <i>continuously</i> option was designed for use with differential corrections over low bit rate data links. This will provide optimal record generation rates. The next record will not be generated until the last byte of the previous record is loaded into the output buffer of the UART.	ONTIME
period	Use only with the <i>ONTIME</i> trigger. Units for this parameter are seconds. The selected period may be any of the following values: 0.05, 0.10, 0.20, 0.25, 0.50, 1, 2, 3, ... , 3600 seconds but may be limited by the GPSCard model and previously requested logs. Selected data is logged immediately and then periodic logging of the data will start at the next even multiple of the period. If a period of 0.20 sec is chosen, then data will be logged when the receiver time is at the 0.20, 0.40, 0.60 and the next (0.80) second marks. If the period is 15 seconds, then the logger will log the data when the receiver time is at even 1/4 minute marks. The same rule applies even if the chosen period is not divisible into its next second or minute marks. If a period of 7 seconds is chosen, then the logger will log at the multiples of 7 seconds less than 60, that is, 7, 14, 21, 28, 35, 42, 49, 56 and every 7 seconds thereafter.	60
offset	Use only with the <i>ONTIME</i> trigger. Units for this parameter are seconds. It provides the ability to offset the logging events from the above startup rule. If you wished to log data at 1 second after every minute you would set the period to 60 seconds and the offset to 1 second (Default is 0).	1
hold	Will prevent a log from being removed when the UNLOGALL command is issued	HOLD

Example:

```
log com1,posa,ontime,60,1
```

If the LOG syntax does not include a *trigger* type, it will be output only once following execution of the LOG command. If *trigger* type is specified in the LOG syntax, the log will continue to be output based on the *trigger*

specification. Specific logs can be disabled using the UNLOG command, whereas all enabled logs will be disabled by using the UNLOGALL command (see *Chapter 2, Page 24* and *Appendix C, Page 134*). All activated logs will be listed in the receiver configuration status log (RCCA).

3.2 NOVATEL FORMAT DATA LOGS

General

The GPSCard is capable of executing more than 40 NovAtel format log commands. Each log is selectable in ASCII and Binary formats. The one exception to this rule is the RGE log, which can be logged as RGED. The “D” indicates a compressed binary format to allow higher speed logging. Any format can be selected individually or simultaneously over the same COMn ports.

All of the log descriptions are listed in alphabetical order in *Appendix D*. Each log first lists the ASCII format, followed by the Binary format description.

ASCII Log Structure

Log types ending with the letter A (or a) will be output in ASCII format (e.g., POSA). The structures of all ASCII logs follow the general conventions as noted here:

1. The lead code identifier for each record is '\$'.
2. Each log is of variable length depending on amount of data and formats.
3. All data fields are delimited by a comma ',' with the exception of the last data field, which is followed by a * to indicate end of message data.
4. Each log ends with a hexadecimal number preceded by an asterisk and followed by a line termination using the carriage return and line feed characters, e.g., *xx[CR][LF]. This 8-bit value is an exclusive OR (XOR) of all bytes in the log, excluding the '\$' identifier and the asterisk preceding the two checksum digits.

Structure:

```
$xxxx, data field..., data field..., data field... *xx [CR][LF]
```

Binary Log Structure

Log types ending with the letter B (or b) will be output in Binary format (e.g., POSB). The structures of all Binary logs follow the general conventions as noted here:

1. Basic format of:

Sync	3 bytes
Checksum	1 byte
Message ID	4 bytes unsigned integer
Message byte count	4 bytes unsigned integer
Data	x
2. The Sync bytes will always be:

Byte	Hex	Decimal
First	AA	170
Second	44	68
Third	11	17

3. The Checksum is an XOR of all the bytes (including the 12 header bytes) and is initially set to 00.
4. The Message ID identifies the type of log to follow.
5. The Message byte count equals the total length of the data block including the header.

NOTE: Maximum flexibility for logging data is provided to the user by these logs. The user is cautioned, however, to recognize that each log requested requires additional CPU time and memory buffer space. Too many logs may result in lost data and degraded CPU performance. CPU overload can be monitored using the idle-time and buffer overload bits from the RCSA/B log. See *Table D-5, Page 198* (GPSCard Receiver Self-test Status Codes).

The following table describes the format types used in the description of binary logs.

Type	Size (bytes)	Size (bits)	Description
char	1	8	The char type is used to store the integer value of a member of the representable character set. That integer value is the ASCII code corresponding to the specified character.
int	4	32	The size of a signed or unsigned int item is the standard size of an integer on a particular machine. On a 32-bit processor (such as the NovAtel GPSCard), the int type is 32 bits, or 4 bytes. The int types all represent signed values unless specified otherwise. Signed integers are represented in two's-complement form. The most-significant bit holds the sign: 1 for negative, 0 for positive and zero.
double	8	64	The double type contains 64 bits: 1 for sign, 11 for the exponent, and 52 for the mantissa. Its range is $\pm 1.7E308$ with at least 15 digits of precision.
float	4	32	The float type contains 32 bits: 1 for the sign, 8 for the exponent, and 23 for the mantissa. Its range is $\pm 3.4E38$ with at least 7 digits of precision.

Each byte within an **int** has its own address, and the smallest of the addresses is the address of the int. The byte at this lowest address contains the eight least significant bits of the doubleword, while the byte at the highest address contains the eight most significant bits. The following illustration shows the arrangement of bytes within words and doublewords. Similarly the bits of a "double" type are stored least significant byte first. This is the same data format used by IBM PC computers.

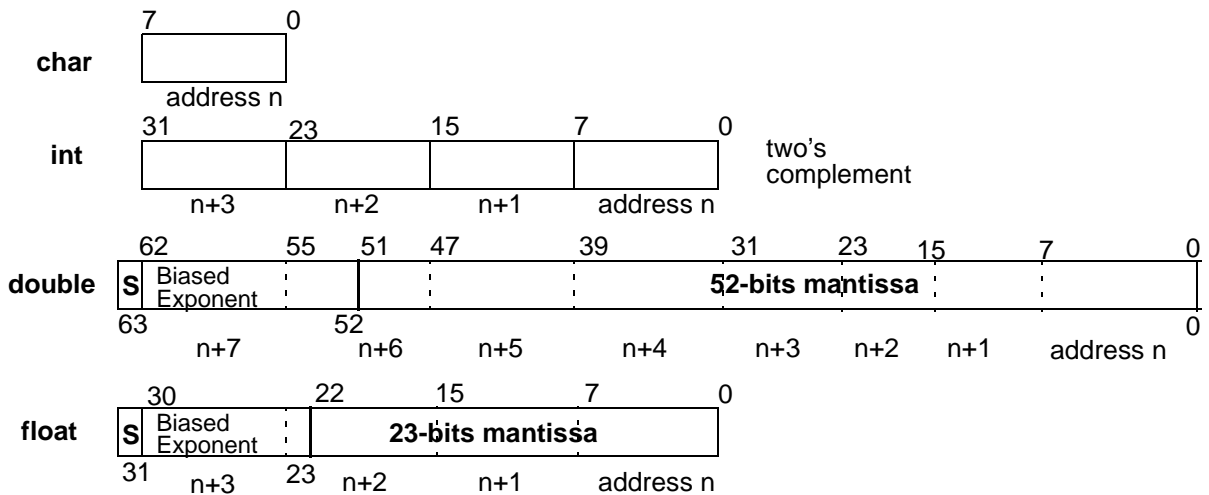

3.3 RTK

After setting up your system and initializing the positioning algorithms, as described in the *RTK* section of *Chapter 1*. You can use the logs listed in this section to record the data collected. The low-latency-solution logs (e.g. PRTKA/B) are recommended for kinematic users, while the matched-solution logs (e.g. RTKA/B) are recommended for stationary users. For a discussion on low-latency and matched solutions, see the *Differential Positioning* section in *Appendix A, Page 67*.

A matched solution is *always* a carrier-phase differential solution, and consequently offers the greatest possible accuracy. A low-latency solution, on the other hand, is the best one that is currently available; the possibilities are categorized as follows, starting with the one offering the greatest accuracy and precision:

1. Carrier-phase differential solution
2. Pseudorange differential solution
3. Single-point solution

Therefore, if an RTK solution is not available, then a low-latency-solution log will contain a pseudorange differential solution if it exists. If neither an RTK nor a pseudorange differential solution is available, then a low-latency-solution log will contain a single-point solution.

3.4 NMEA FORMAT DATA LOGS

General

The NMEA log structures follow format standards as adopted by the National Marine Electronics Association. The reference document used is "Standard For Interfacing Marine Electronic Devices NMEA 0183 Version 2.00". For further information, see *Appendix F, Standards and References, Page 239*. The following table contains excerpts from Table 6 of the NMEA Standard which defines the variables for the NMEA logs. The actual format for each parameter is indicated after its description.

Field Type	Symbol	Definition
Special Format Fields		
Status	A	Single character field: A = Yes, Data Valid, Warning Flag Clear V = No, Data Invalid, Warning Flag Set
Latitude	lll.ll	Fixed/Variable length field: degrees minutes.decimal - 2 fixed digits of degrees, 2 fixed digits of minutes and a <u>variable</u> number of digits for decimal-fraction of minutes. Leading zeros always included for degrees and minutes to maintain fixed length. The decimal point and associated decimal-fraction are optional if full resolution is not required.
Longitude	yyyy.yy	Fixed/Variable length field: degrees minutes.decimal - 3 fixed digits of degrees, 2 fixed digits of minutes and a <u>variable</u> number of digits for decimal-fraction of minutes. Leading zeros always included for degrees and minutes to maintain fixed length. The decimal point and associated decimal-fraction are optional if full resolution is not required.
Time	hhmmss.ss	Fixed/Variable length field: hours minutes seconds.decimal - 2 fixed digits of hours, 2 fixed digits of minutes, 2 fixed digits of seconds and <u>variable</u> number of digits for decimal-fraction of seconds. Leading zeros always included for hours, minutes and seconds to maintain fixed length. The decimal point and associated decimal-fraction are optional if full resolution is not required.
Defined field		Some fields are specified to contain pre-defined constants, most often alpha characters. Such a field is indicated in this standard by the presence of one or more valid characters. Excluded from the list of allowable characters are the following which are used to indicate field types within this standard: "A", "a", "c", "hh", "hhmmss.ss", "lll.ll", "x", "yyyy.yy"
Numeric Value Fields		
Variable numbers	x.x	Variable length integer or floating numeric field. Optional leading and trailing zeros. The decimal point and associated decimal-fraction are optional if full resolution is not required (example: 73.10 = 73.1 = 073.1 = 73)
Fixed HEX field	hh__	Fixed length HEX numbers only, MSB on the left
Information Fields		
Variable text	c--c	Variable length valid character field.
Fixed alpha field	aa__	Fixed length field of uppercase or lowercase alpha characters
Fixed number	xx__	Fixed length field of numeric characters
Fixed text field	cc__	Fixed length field of valid characters
NOTES:		
<ol style="list-style-type: none"> 1. Spaces may only be used in variable text fields. 2. A negative sign "-" (HEX 2D) is the first character in a Field if the value is negative. The sign is omitted if value is positive. 3. All data fields are delimited by a comma (,). 4. Null fields are indicated by no data between two commas (,). Null fields indicate invalid or no data available. 5. The NMEA Standard requires that message lengths be limited to 82 characters. 		

3.5 GPS TIME VS. LOCAL RECEIVER TIME

All logs report GPS time expressed in GPS weeks and seconds into the week. The time reported is not corrected for local receiver clock error. To derive the closest GPS time, one must subtract the clock offset shown in the

CLKA log (field 4) from GPS time reported.

GPS time is based on an atomic time scale. Universal Time Coordinated (UTC) time (reported in NMEA logs) is also based on an atomic time scale, with an offset of seconds applied to coordinate Universal Time to GPS time. GPS time is designated as being coincident with UTC at the start date of January 6, 1980 (00 hours). GPS time does not count leap seconds, and therefore an offset exists between UTC and GPS time. The GPS week consists of 604800 seconds, where 000000 seconds is at Saturday midnight. Each week at this time, the week number increments by one, and the seconds into the week resets to 0. (See *Appendix H, Some Common Unit Conversions, Page 242* for an example)

3.6 STANDARD LOG TABLES

Table 3-1 lists the logs by function while *Table 3-2* is an alphabetical listing of logs. Please see *Appendix D, Page 138* for a more detailed description of individual NovAtel and NMEA format logs which are listed alphabetically. RTCM and RTCA format data logs and receiver-independent RINEX logs will be found in *Chapter 4*. Special Pass-Through logs are found in *Section 3.8*.

Table 3-1 Logs By Function Table

COMMUNICATIONS, CONTROL AND STATUS	
Logs	Descriptions
CDSA/B	COM port communications status
COM1A/B	Log data from COM1
COM2A/B	Log data from COM2
COMnA/B	Pass-through data logs
RCSA/B	Receiver self-test status
RTCM16T	NovAtel ASCII format special message
RTCM16	RTCM format special message

GENERAL RECEIVER CONTROL AND STATUS	
Logs	Descriptions
PVAA/B	Receiver's latest computed position, velocity and acceleration in ECEF coordinates
RCCA	Receiver configuration status
RCSA/B	Version and self-test status
RVSA/B	Receiver status
VERA/B	Receiver hardware and software version numbers

POSITION, PARAMETERS, AND SOLUTION FILTERING CONTROL	
Logs	Descriptions
DOPA/B	DOP of SVs currently tracking
GGAB	GPS fix data
GPGGA	NMEA, position data
GPGLL	NMEA, position data
GPGRS	NMEA, range residuals
GPGSA	NMEA, DOP information
GPGST	NMEA, measurement noise statistics
MKPA/B	Position at time of mark
POSA/B	Position data
PRTKA/B	Computed position
PVAA/B	Computed position, velocity and acceleration in ECEF coordinates
PXYA/B	Position (Cartesian x,y,z coordinates)
RTKA/B	Computed position
SPHA/B	Speed and direction over ground

Table 3-1 Logs By Function Table (continued)

SATELLITE TRACKING AND CHANNEL CONTROL	
Logs	Descriptions
ALMA/B	Current decoded almanac data
DOPA/B	DOP of SVs currently tracking
ETSA/B	Provides channel tracking status information for each of the GPSCard parallel channels
GPALM	NMEA, almanac data
GPGSA	NMEA, SV DOP information
GPGSV	NMEA, satellite-in-view information
RALA/B	Raw almanac
RASA/B	Raw GPS almanac set
RGEA/B/D	Satellite range measurements
SATA/B	Satellite specific information
SBTA/B	Satellite broadcast data (raw symbols)
SVDA/B	SV position (ECEF xyz)
WALA/B	WAAS Almanac
WRCA/B	Wide band range correction data (grouped format)

WAYPOINT NAVIGATION	
Logs	Descriptions
GPRMB	NMEA, waypoint status
GPRMC	NMEA, navigation information
GPVTG	NMEA, track made good and speed
GPZTG	NMEA, time to destination
MKPA/B	Position at time of mark input
NAVA/B	Navigation waypoint status
POSA/B	Position data
SPHA/B	Speed and course over ground
VLHA/B	Velocity, latency & direction over ground

DIFFERENTIAL REFERENCE STATION	
Logs	Descriptions
ALMA/B	Current almanac information
CDSA/B	COM port data transmission status
CMR	Pseudorange and carrier phase data
PAVA/B	Parameters being used in the position averaging process
RGEA/B/D	Channel range measurements
RPSA/B	Reference station position and health
RTCAA/B	Transmits RTCA differential corrections in NovAtel ASCII or Binary
RTCM1	Transmits RTCM SC104 standard corrections
RTCM3	Reference position
RTCM1819	Uncorrected carrier phase and pseudorange measurements
RTCM22	Extended reference station parameters
RTCM59	NovAtel format RT-20 observation data
RTCMA/B	Transmits RTCM information in NovAtel ASCII/binary
SATA/B	Satellite specific information

Table 3-1 Logs By Function Table (continued)

DIFFERENTIAL REMOTE STATION	
Logs	Descriptions
CDSA/B	Communication and differential decode status
GPGGA	NMEA, position fix data
GGAB	NovAtel binary version of GPGGA
POSA/B	Position information
PRTKA/B	Computed Position – best available
RTKA/B	Computed Position – Time Matched
RTKOA/B	RTK Output
SATA/B	Satellite specific information
SVDA/B	SV position in ECEF XYZ with corrections
VLHA/B	Velocity, latency & direction over ground

POST PROCESSING DATA	
Logs	Descriptions
BSLA/B	Most recent matched baseline expressed in ECEF coords.
CLKA/B	Receiver clock offset information
REPA/B	Raw ephemeris information
RGEA/B/D	Satellite and ranging information
SATA/B	Satellite specific information
SVDA/B	SV position in ECEF XYZ with corrections
WEPA/B	WAAS ephemeris information

CLOCK INFORMATION, STATUS, AND TIME	
Logs	Descriptions
CLKA/B	Receiver clock offset information
CLMA/B ¹	Current clock-model matrices of the GPSCard
GPZDA	NMEA, UTC time and date
GPZTG	NMEA, UTC and time to waypoint
MKTA/B	Time of mark input
TM1A/B	Time of 1PPS
WUTCA/B	WAAS, UTC time parameters

¹ Intended for advanced users of GPS only.

NAVIGATION DATA	
Logs	Descriptions
FRMA/B	Framed raw navigation data
RALA/B	Raw almanac and health data
RASA/B	Raw almanac set
RBTA/B	Satellite broadcast data in raw bits
REPA/B	Raw ephemeris data

Table 3-2 GPSCard Log SummarySyntax: `log port,datatype,[trigger],[period],[offset],[hold]`

NovAtel Format Logs			
Datatype	Description	Datatype	Description
ALMA/B	Decoded Almanac	RCCA	Receiver Configuration
BSLA/B	Baseline Measurement	RCSA/B	Receiver Status
CDSA/B	Communication and Differential Decode Status	REPA/B	Raw Ephemeris
CLKA/B	Receiver Clock Offset Data	RGEA/B/D	Channel Range Measurements
CLMA/B	Receiver Clock Model	RPSA/B	Reference Station Position and Health
COM1A/B	Log data from COM1	RTCAA/B	RTCA format Differential Corrections with NovAtel headers
COM2A/B	Log data from COM2	RTKA/B	Computed Position - Time Matched
DOPA/B	Dilution of Precision	RTKOA/B	RTK Solution Parameters
ETSA/B	Extended Tracking Status	RTCMA/B	RTCM Type 1 Differential Corrections with NovAtel headers
FRMA/B	Framed Raw Navigation Data	RTCM16T	Special Message
GGAB	Global Position System Fix Data - Binary Format	RVSA/B	Receiver Status
MKPA/B	Mark Position	SATA/B	Satellite Specific Data
MKTA/B	Time of Mark Input	SBTA/B	Satellite Broadcast Data (Raw Symbols)
NAVA/B	Navigation Data	SPHA/B	Speed and Direction Over Ground
PAVA/B	Positioning Averaging Status	SVDA/B	SV Position in ECEF XYZ Coordinates with Corrections
POSA/B	Computed Position	TM1A/B	Time of 1PPS
PRTKA/B	Computed Position	VERA/B	Receiver Hardware and Software Version Numbers
PVAA/B	XYZ Position, Velocity and Acceleration	VLHA/B	Velocity, Latency, and Direction over Ground
PXYA/B	Computed Cartesian Coordinate Position	WALA/B	WAAS Almanac
RALA/B	Raw Almanac	WEPA/B	WAAS Ephemeris
RASA/B	Raw GPS Almanac Set	WRCA/B	Wide Band Range Correction (Grouped)
RBTA/B	Satellite Broadcast Data: Raw Bits	WUTCA/B	WAAS, UTC Time Parameters
NMEA Format Logs			
GPALM	Almanac Data	GPGSV	GPS Satellites in View
GPGGA	Global Position System Fix Data	GPRMB	Generic Navigation Information
GPGLL	Geographic Position - lat/lon	GPRMC	GPS Specific Information
GPGRS	GPS Range Residuals for Each Satellite	GPVTG	Track Made Good and Ground Speed
GPGSA	GPS DOP and Active Satellites	GPZDA	UTC Time and Date
GPGST	Pseudorange Measurement Noise Statistics	GPZTG	UTC & Time to Destination Waypoint
RTCA Format			
RTCA	RTCA Differential Corrections: Type 1 and Type 7		
RTCM Format			
RTCM1	Type 1 Differential GPS Corrections		
RTCM3	Type 3 Reference Station Parameters		
RTCM9	Type 9 Partial Satellite Set Differential Corrections		
RTCM16	Type 16 Special Message		
RTCM1819	Type 18 and Type 19 Uncorrected Carrier Phase and Pseudorange Corrections		
RTCM22	Type 22 Extended Reference Station Parameters		
RTCM59	Type 59N-0 NovAtel Proprietary Message: RT20 Differential Observations		

Note: A/B/D:

- A refers to GPSCard output logs in ASCII format.
- B refers to GPSCard output logs in Binary format.
- D refers to GPSCard output logs in compressed binary format.

3.7 WAAS

The Wide Area Augmentation System (WAAS) is a safety-critical system that provides a quality of positioning information previously unavailable. The WAAS improves the accuracy, integrity, and availability of the basic GPS signals.

3.7.1 WAAS GPSCard Logs

The log WALA/B (see its descriptions on *Page 224*), provide WAAS satellite-specific data. For more information on MiLLennium GPSCards with the WAAS option, see *Page 30*.

3.8 PASS-THROUGH LOGS

The pass-through logging feature enables the GPSCard to redirect any ASCII or binary data that is input at a specified port (COM1 or COM2) to any specified GPSCard port (COM1 or COM2). This capability, in conjunction with the SEND command, can allow the GPSCard to perform bi-directional communications with other devices such as a modem, terminal, or another GPSCard.

There are two pass-through logs **COM1A/B** and **COM2A/B**, available on MiLLennium GPSCards.

Pass-through is initiated the same as any other log, i.e., LOG [to-port] [data-type-A/B] [trigger]. However, pass-through can be more clearly specified as: LOG [to-port] [from-port-A/B] [onchanged]. Now, the [from-port-A/B] field designates the port which accepts data (i.e., COM1 or COM2) as well as the format in which the data will be logged by the [to-port] — (A for ASCII or B for Binary).

When the [from-port-A/B] field is designated with an **[A]**, all data received by that port will be redirected to the [to-port] in **ASCII** format and will log according to standard NovAtel ASCII format. Therefore, all incoming ASCII data will be redirected and output as ASCII data. However, any binary data received will be converted to a form of ASCII hexadecimal before it is logged.

When the [from-port-A/B] field is designated with a **[B]**, all data received by that port will be redirected to the [to-port] exactly as it is received. The log header and time-tag adhere to standard NovAtel Binary Format followed by the pass-through data as it was received (ASCII or binary).

Pass-through logs are best utilized by setting the **[trigger]** field as **onchanged** or **onnew**. Either of these two triggers will cause the incoming data to log when any one of the following conditions is met:

- Upon receipt of a <CR> character
- Upon receipt of a <LF> character
- Upon receipt of 80 characters
- 1/2 second timeout following receipt of last character

Each pass-through record transmitted by the GPSCard is time tagged by the GPSCard clock in GPS weeks and seconds.

For illustration purposes, you could connect two GPSCards together via their COM1 ports such as in a reference station, labelled as reference station in *Figure 3-1*, to remote station scenario. If the reference station were logging PVAA data to the remote station, it would be possible to use the pass-through logs to pass through the received PVAA differential correction data to a disk file (let's call it DISKFILE.log) at the remote station host PC hard disk.

Figure 3-1 Pass-Through Log Data

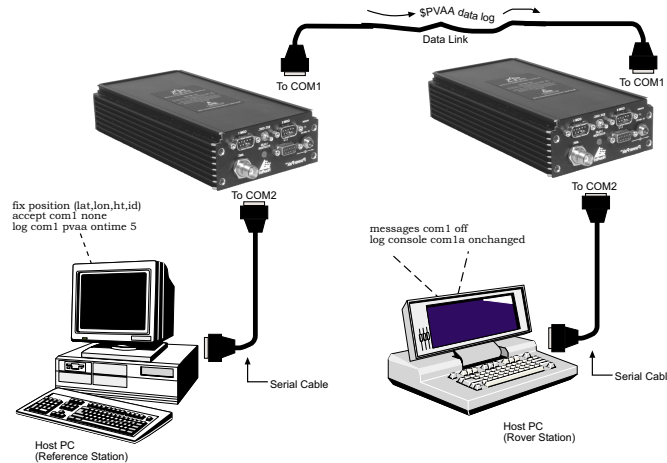

When pass-through logs are being used, the GPSCard’s command interpreter continues to monitor the port for valid input commands and replies with error messages when the data is not recognized as such. If you do not want the pass-through input port to respond with error messages during unrecognized data input, see the MESSAGES command, *Appendix C, Page 110* for details on how to inhibit the port’s error message responses. As well, if you do not want the reference station to accept any input from the remote device, use the ACCEPT NONE command to disable the port’s command interpreter.

3.8.1 Command Syntax

Syntax:

```
log to-port from-port-A/B trigger
```

Syntax	Range Value	Description	Default
log	—	Log command	unlogall
to-port	COM1, COM2	Port that will output the pass-through log data	—
from-port-[A/B]	COM1A/B, COM2A/B	Port that will accept input data: [A] option logs data as ASCII, [B] option logs data with binary header	—
trigger	onchanged or onnew	log will output upon receipt of: <CR>, <LF>, 80 characters, or 1/2 sec. timeout	—

Example 1:

```
log com2 com1a onchanged
```

3.8.2 ASCII Log Structure

```
$port ID week seconds pass-through data *xx [CR][LF]
```

Field #	Field type	Data Description	Example
1	\$port ID	Log header: Identifies port accepting input data	\$COM1
2	week	GPS week number	747
3	seconds	GPS seconds into the week at time of log	347131.23
4	pass-through data	Data accepted into COM1 (up to 80 characters)	\$TM1A,747,347131.000000000, 0.000000058,0.000000024, -9.000000009,0*78<CR>
5	*xx	Checksum	*2E
6	[CR][LF]	Sentence terminator	[CR][LF]

Example 1:

```
$COM1,747,347131.23,$TM1A,747,347131.000000000,0.000000058,0.00000
0024,-9.000000009,0*78<CR>*2E[CR][LF]
$COM1,747,347131.31,<LF>*4F[CR][LF]
$COM1,747,347131.40,Invalid Command Option<LF>*7C[CR][LF]
$COM1,747,347131.42,Com1>Invalid Command Option<LF>*30[CR][LF]
$COM1,747,347131.45,Com1>*0A[CR][LF]
```

Example 1, above, shows what would result if a GPSCard logged TM1A data into the COM1 port of another GPSCard, where the accepting card is redirecting this input data as a pass-through log to its COM2 port (log com2 com1a unchanged). Under default conditions the two cards will "chatter" back and forth with the *Invalid Command Option* message (due to the command interpreter in each card not recognizing the command prompts of the other card). This *chattering* will in turn cause the accepting card to transmit new pass-through logs with the response data from the other card. To avoid this chattering problem, use the GPSCard MESSAGES command on the accepting port to disable error reporting from the receiving port command interpreter or if the incoming data is of no use to the GPSCard, then disable the command interpreter with the ACCEPT NONE command.

If the accepting port's error reporting is disabled by MESSAGES OFF, the \$TM1A data record would pass through creating two records as follows:

Example 1a:

```
$COM1,747,347204.80,$TM1A,747,347203.999999957,-
0.000000015,0.000000024,
-9.000000009,0*55<CR>*00[CR][LF]
$COM1,747,347204.88,<LF>*48[CR][LF]
```

The reason that two records are logged from the accepting card is because the first record was initiated by receipt of the \$TM1A log's first terminator <CR>. Then the second record followed in response to the \$TM1A log's second terminator <LF>.

Note that the time interval between the first character received (\$) and the terminating <LF> can be calculated by differencing the two GPS time tags (0.08 seconds). This pass-through feature is useful for time tagging the arrival of external messages. These messages could be any user-related data. If the user is using this feature for tagging external events then it is recommended that the command interpreter be disabled so that the GPSCard does not respond to the messages. See the ACCEPT command in *Chapter 2, Page 24* and *Appendix C, Page 81*.

Example 1b illustrates what would result if \$TM1B binary log data were input to the accepting port (i.e., log com2 com1a unchanged).

Example 1b:

```
$COM1,747,349005.18,<AA>D<DC1>k<ETX><NUL><NUL><NUL>4<NUL><NUL><NUL>
<EB><STX><NUL><NUL><FE>3M<NAK>A<VT><83><D6>o<82><C3>Z<BE><FC><97>I
<91><C5>iV<7F><8F>O<NUL><NUL><NUL>"<C0><NUL><NUL><NUL><NUL>*6A
```

As can be seen, the \$TM1B binary data at the accepting port was converted to a variation of ASCII hexadecimal before it was passed through to COM2 port for logging (MESSAGES command set to OFF).

3.8.3 Binary Log Structure

Format: Message ID = 30 for COM1B; 31 for COM2B
 Message byte count = 24 + (length of pass-through data string received (80 maximum))

Field #	Data	Bytes	Format	Units	Offset
1 (header)	Sync	3	char		0
	Checksum	1	char		3
	Message ID	4	integer		4
	Message byte count	4	integer		8
2	Week number	4	integer	weeks	12
3	Seconds of week	8	double	seconds	16
4	Pass-through data as received	variable	char		24 + (variable data)

4

MESSAGE FORMATS

In a NovAtel RTK positioning system, the observations transmitted by a NovAtel reference station to a NovAtel remote station can be in either a proprietary RTCA Type 7 or a proprietary RTCM Type 59N message format. A NovAtel Rover station is also able to receive CMR-format messages, *Section 4.3*, from a non-NovAtel base station.

Table 4-1 illustrates the various combinations of hardware and message formats, together with the positioning mode (RT-20 or RT-2) which will result when using all-NovAtel devices:

Table 4-1 Positioning Modes

	Reference station: L1 RTCM Type 59N	Reference station: L1 RTCA Type 7	Reference station: L1 & L2 RTCM Type 59N	Reference station: L1 & L2 RTCA Type 7
Remote station: L1	RT-20	RT-20	RT-20	RT-20
Remote station: L1 & L2	RT-20	RT-20	RT-20	RT-2

The following information can be used to calculate the minimum data throughput required of the communications data link. Keep in mind that manufacturers of communication equipment add extra bits to each message (e.g. for error detection), forming an “overhead” that must be taken into account; also, radio transmitting equipment may have a duty cycle which must also be factored into the calculations. Thus, a “4800 bits per second” radio modem might actually sustain only 2000 bits per second. Consult the documentation supplied by the manufacturer of your communications equipment.

4.1 RTCA-FORMAT MESSAGES

NovAtel has defined two proprietary RTCA Standard Type 7¹ binary-format messages RTCAOBS and RTCAREF, for reference station transmissions. These can be used with either single or dual-frequency NovAtel receivers; existing users of RT-20 wishing to switch from RTCM to RTCA message formats will require a software upgrade. The RTCA message format outperforms the RTCM format in the following ways, among others:

- a more efficient data structure (lower overhead)
- better error detection
- allowance for a longer message, if necessary

RTCAREF and RTCAOBS, respectively, correspond to the RTCM Type 3 and Type 59 logs used in single-frequency-only measurements. Both are NovAtel-proprietary RTCA Standard Type 7 messages with an ‘N’ primary sub-label.

RTCAOBS TYPE 7

An RTCAOBS (RTCA Reference-Station Satellite Observations) message contains reference station satellite observation information. It is used to provide range observations to the remote receiver, and should be sent every 1 or 2 seconds. This log is made up of variable-length messages up to 255 bytes long. The maximum number of bits in this message is $[140 + (92 \times N)]$, where N is the maximum number of satellite record entries transmitted. Using the RTKMODE command, you can define N to be anywhere from 4 to 20; the default value is 12.

1. For further information on RTCA Standard Type 7 messages, you may wish to refer to:
Minimum Aviation System Performance Standards - DGNSS Instrument Approach System: Special Category I (SCAT-I), Document No. RTCA/DO-217 (April 19,1995); Appendix A, Page 21.

RTCAREF TYPE 7

An RTCAREF (RTCA Reference Station Position Information) message contains reference station position information, and should be sent once every 10 seconds. Each message is 24 bytes (192 bits) long.

If RTCA-format messaging is being used, the optional *station id* field that is entered using the FIX POSITION command can be any 4-character string combining numbers and upper-case letters, and enclosed in quotation marks (e.g. "RW34"). Note that the representation of this string in the log message would be a number within the range of 266,305 to 15,179,385 as per RTCA notation. The lower bound of 266,305 represents "AAAA" and the upper bound of 15,179,385 represents "9999".

RTCA Standard Logs

The RTCA (Radio Technical Commission for Aviation Services) Standard is being designed to support Differential Global Navigation Satellite System (DGNSS) Special Category I (SCAT-I) precision instrument approaches. The RTCA Standard is in a preliminary state. Described below is NovAtel's current support for this Standard. It is based on "Minimum Aviation System Performance Standards DGNSS Instrument Approach System: Special Category I (SCAT-I)" dated August 27, 1993 (RTCA/DO-217).

RTCA

This log enables transmission of RTCA Standard format Type 1 messages from the GPSCard when operating as a reference station. Before this message can be transmitted, the GPSCard FIX POSITION command must be set. The RTCA log will be accepted by a GPSCard operating as a remote station over a COM port after an ACCEPT *port* RTCA command is issued.

The RTCA Standard for SCAT-I stipulates that the maximum age of differential correction (Type 1) messages accepted by the remote station cannot be greater than 22 seconds. See the DGPSTIMEOUT command in *Chapter 2, Page 24* and *Appendix C, Page 92* for information regarding DGPS delay settings.

The RTCA Standard also stipulates that a reference station shall wait five minutes after receiving a new ephemeris before transmitting differential corrections. See the DGPSTIMEOUT command for information regarding ephemeris delay settings.

The basic SCAT-I Type 1 differential correction message is as follows:

Format: Message length = 11 + (6*obs): (83 bytes maximum)

Field Type	Data	Bits	Bytes
SCAT-I header	- Message block identifier	8	6
	- Reference station ID	24	
	- Message type (this field will always report 00000001)	8	
	- Message length	8	
Type 1 header	- Modified z-count	13	2
	- Acceleration error bound (In the GPSCard, this field will report 000)	3	
Type 1 data	- Satellite ID	6	6 * obs
	- Pseudorange correction ¹	16	
	- Issue of data	8	
	- Range rate correction ¹	12	
	- UDRE	6	
CRC	Cyclic redundancy check		3

¹ The pseudorange correction and range rate correction fields have a range of ±655.34 meters and ±4.049 m/s respectively. Any satellite which exceeds these limits will not be included.

RTCAA

This log contains the same data available in the RTCA SCAT-I message, but has been modified to allow flexibility in using the RTCA data. The RTCA data has been reformatted to be available in ASCII hexadecimal, utilizing a NovAtel header and terminates with a checksum.

This message was designed so that RTCA data can be intermixed with other NovAtel ASCII data over a common communications port. The log is not in pure RTCA format. The header (\$RTCA) and terminator (*xx) must be stripped off at the receiving end, then the data will need to be converted from hexadecimal to binary before the RTCA information is retrieved.

The RTCAA log can be directly decoded by other NovAtel GPSCard receivers operating as remote stations. They will recognize the \$RTCA header as a special data input command and the differential corrections data will be directly applied. The GPSCard remote station receiving this log must have the ACCEPT command set to "ACCEPT port COMMANDS".

Structure:

\$RTCA	data	*xx	[CR][LF]
--------	------	-----	----------

Field #	Field Type	Data Description	Example
1	\$RTCA	Log header	\$RTCA
2	data	SCAT-I type 1 differential corrections	990000000447520607BE7C92FA0B82423E9FE507DF5F3FC9FD071AFC7FA0D207D090808C0E045BACC055E9075271FFB0200413F43FF810049C9DFF8FFD074FCF3C940504052DFB
3	*xx	Checksum	*20
4	[CR][LF]		[CR][LF]

Example:

```
$RTCA,990000000447520607BE7C92FA0B82423E9FE507DF5F3FC9FD071AFC7FA0
D207D090808C0E045BACC055E9075271FFB0200413F43FF810049C9DFF8FFD074F
CF3C940504052DFB*20[CR][LF]
```

RTCAB

The RTCAB log contains the SCAT-I differential corrections message with the standard NovAtel binary log preamble (header) added. The RTCAB log will be accepted by the GPSCard over a COM port after an "ACCEPT port RTCA" command is issued.

Format: Message ID = 38 Message byte count = 12 + (11+(6*obs)): 95 bytes maximum

Field #	Data	Bytes	Format	Offset
1 (header)	Sync	3	char	0
	Checksum	1	char	3
	Message ID	4	integer	4
	Message byte count	4	integer	8
2	- Message block identifier	6		12
	- Reference station ID			
	- Message type			
	- Message length			
3	- Modified z-count	2		18
	- Acceleration error bound			
4	- Satellite ID	6		20
	- Pseudorange correction			
	- Issue of data			
	- Range rate correction			
	- UDRE			
5	Next PRN offset = 26 + (6*obs) where obs varies from 0 to (obs-1)			
6	CRC	3		

4.2 RTCM-FORMAT MESSAGES

The Radio Technical Commission for Maritime Services (RTCM) was established to facilitate the establishment of various radio navigation standards, which includes recommended GPS differential standard formats.

The standards recommended by the Radio Technical Commission for Maritime Services Special Committee 104,

Differential GPS Service (RTCM SC-104, Washington, D.C.), have been adopted by NovAtel for implementation into the GPSCard. Because the GPSCard is capable of utilizing RTCM formats, it can easily be integrated into positioning systems around the globe.

As it is beyond the scope of this manual to provide in-depth descriptions of the RTCM data formats, it is recommended that anyone requiring explicit descriptions of such, should obtain a copy of the published RTCM specifications. See *Appendix F, Page 239* for reference information.

RTCM SC-104² Type 3 & 59 messages can be used for reference station transmissions in differential systems. However, since these messages do not include information on the L2 component of the GPS signal, they cannot be used with RT-2 positioning. Regardless of whether single or dual-frequency receivers are used, the RT-20 positioning algorithm would be used. This is for a system in which both the reference and remote stations utilize NovAtel receivers.

Note that the error-detection capability of an RTCM-format message is less than that of an RTCA-format message. The communications equipment that you use may have an error-detection capability of its own to supplement that of the RTCM message, although at a penalty of a higher overhead (see the discussion at the beginning of this chapter, *Page 46*). Consult the vendor's documentation for further information.

- **RTCM Type 3 Reference Station Position**

A Type 3 message contains reference station position information. This message must be sent at least once every 30 seconds, although it is recommended that it be sent once every 10 seconds. It uses four RTCM data words following the two-word header, for a total frame length of six 30-bit words (180 bits).

- **RTCM Type 59 NovAtel Proprietary (RT-20)**

A Type 59N message contains reference station satellite observation information, and should be sent once every 2 seconds. It is variable in size, and can be up to thirty three 30-bit words (990 bits) long.

If RTCM-format messaging is being used, the optional *station id* field that is entered using the FIX POSITION command can be any number within the range of 0 - 1023 (e.g. 119). The representation in the log message would be identical to what was entered.

RTCM General Message Format

All GPSCard RTCM standard format logs adhere to the structure recommended by RTCM SC-104. Thus, all RTCM message are composed of 30 bit words. Each word contains 24 data bits and 6 parity bits. All RTCM messages contain a 2-word header followed by 0 to 31 data words for a maximum of 33 words (990 bits) per message

Message Frame Header	Data	Bits
Word 1	- Message frame preamble for synchronization	8
	- Frame/message type ID	6
	- reference station ID	10
	- Parity	6
Word 2	- Modified z-count (time tag)	13
	- Sequence number	3
	- Length of message frame	5
	- reference station health	3
	- Parity	6

The remainder of this section will provide further information concerning GPSCard commands and logs that utilize the RTCM data formats.

2. For further information on RTCM SC-104 messages, you may wish to refer to:
 RTCM Recommended Standards for Differential Navstar GPS Service, Version 2.1, RTCM Paper 194-93/SC104-STD (January 3, 1994)

RTCM Standard Commands

RTCMRULE

The RTCM standard states that all equipment shall support the use of the "6 of 8" format (data bits a₁ through a₆ where bits a₁ through a₆ are valid data bits and bit a₇ is set to mark and bit a₈ is set to space).

The GPSCard RTCMRULE command allows for flexibility in the use of the bit rule to accommodate compatibility with equipment that does not strictly adhere to the RTCM stated rule.

Syntax:

RTCMRULE

Syntax	Range Value	Description	Default
RTCMRULE	-	Command	
rule	6CR	6CR is for 6 bits of valid data per byte. Each frame is followed by a <CR> character.	6CR
	6SP	6SP (6 bit special); the RTCM decoder of the remote receiver will ignore the two MSB of the data and hence all 6 bit data will be accepted. This allows users with non-conforming 6 bit rule data to use the NovAtel receiver to accept their RTCM data. The user will not be allowed to enter extra control data such as CR/LF, as this will be treated as RTCM data and cause the parity to fail. This option does not affect RTCM generation. The output will be exactly the same as if the RTCMRULE 6 option was chosen. The upper two bits are always encoded as per RTCM specification.	
	6	6 is for 6 bits of valid data per byte	
	8	8 is for 8 bits of valid data per byte	

Example:

```
rtcmrule 6cr
```

RTCM16T

This is a NovAtel GPSCard command which relates to the RTCM Type 16

This command allows the GPSCard user to set an ASCII text string. Once set, the text string can be transmitted as standard format RTCM Type 16 data (see the RTCM16 log, *Page 54*). The text string entered is limited to a maximum of 90 ASCII characters. This message is useful for a reference station wanting to transmit special messages to remote users.

The text string set here can be verified by observing the RCCA command configuration log. As well, the message text can be transmitted as a NovAtel Format ASCII log by utilizing the "LOG port RTCM16T" command.

Syntax:

RTCM16T

Syntax	Range Value	Description
RTCM16T	-	Command
message	up to 90 characters	ASCII text message

Example:

```
rtcm16t This is a test of the RTCM16T Special Message.
```

RTCM Standard Logs

The NovAtel logs which implement the RTCM Standard Format for Type 1, 3, 9, and 16, 18, 19 and 22 messages are known as the RTCM1 (or RTCM), RTCM3, RTCM9, RTCM16, RTCM1819 and RTCM22 logs, respectively, while Type 59N-0 messages are listed in the RTCM59 log.

NovAtel has created ASCII and binary versions of each of these logs so that RTCM data can be sent or received

along with other NovAtel ASCII and binary data over a common communications port. As per the usual convention, an “A” at the end of the log name denotes the NovAtel ASCII version (e.g. RTCM1A), and a “B” denotes the NovAtel binary version (e.g. RTCM1B). These logs contain the same data that is available in the corresponding RTCM Standard Format messages; however, the data has been “packaged” into NovAtel-format messages.

These NovAtel-format logs are not in pure RTCM SC-104 format and are not directly usable as such. There are two scenarios which affect how these logs are processed:

Case 1: ASCII messages (RTCMxA)

- The NovAtel header (\$RTCMx) and checksum terminator (*yz) must be stripped off at the receiving end; then, the data will need to be converted from hexadecimal to binary before the RTCM information can be retrieved.
- Provided that the GPSCard that is acting as a remote station has its ACCEPT command set to “ACCEPT port COMMANDS” (which is the default setting), the receiving GPSCard will recognize the NovAtel header (\$RTCMxA) as a special data input command, and apply the differential corrections data directly. No extra processing is required.

Case 2: Binary messages (RTCMxB)

- The 12-byte NovAtel header must be stripped off before the RTCM information can be retrieved.
- These binary messages are not presently decoded directly by GPSCards, unlike the ASCII messages.

ASCII

The format of the NovAtel ASCII version of an RTCM log is as follows:

Structure:

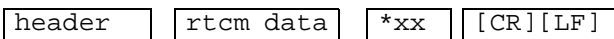

Field #	Field Type	Data Description	Example
1	header	NovAtel format ASCII header	\$RTCM3
2	rtcm data	hexadecimal representation of binary-format RTCM SC104 data	597E7C7F7B76537A66406F49487F797B627A7A5978634E6E7C5155444946
3	*xx	Checksum	*68
4	[CR][LF]	Sentence terminator	[CR][LF]

Example:

```
$RTCM3,597E7C7F7B76537A66406F49487F797B627A7A5978634E6E7C5155444946*68[CR][LF]
```

BINARY

The format of the NovAtel binary version of an RTCM log is as follows:

Field #	Data	Bytes	Format	Offset
1 (header)	Sync	3	char	0
	Checksum	1	char	3
	Message ID	4	integer	4
	Message byte count	4	integer	8
2	RTCM SC104 data	variable		12

RTCM OR RTCM1

This is the primary RTCM log used for pseudorange differential corrections. This log follows RTCM Standard Format for Type 1 messages. It contains the pseudorange differential correction data computed by the reference



station generating this Type 1 log. The log is of variable length, depending on the number of satellites visible and pseudoranges corrected by the reference station. Satellite specific data begins at word 3 of the message.

Structure:

(Follows RTCM Standard for Type 1 message)

Type 1 messages contain the following information for each satellite in view at the reference station:

- Satellite ID
- Pseudorange correction
- Range-rate correction
- Issue of Data (IOD)

When operating as a reference station, the GPSCard must be in FIX POSITION mode before the data can be correctly logged.

When operating as a remote station, the GPSCard COM port receiving the RTCM data must have its ACCEPT command set to "ACCEPT port RTCM".

NOTE: Upon a change in ephemeris, GPSCard reference stations will transmit Type 1 messages based on the old ephemeris for a period of time defined by the DGPSTIMEOUT command. After the timeout, the reference station will begin to transmit the Type 1 messages based on new ephemeris.

RTCMA or RTCM1A

This log contains the same data available in the RTCM Standard Format Type 1 messages, but has been modified to allow flexibility in using the RTCM data. The RTCM data has been reformatted to be available in ASCII hexadecimal, utilizing a NovAtel header and terminates with a checksum.

This message was designed so that RTCM data can be intermixed with other NovAtel ASCII data over a common communications port. The log is not in pure RTCM SC104 format. The header (\$RTCM) and terminator (*xx) must be stripped off at the receiving end, then the data will need to be converted from hexadecimal to binary before the RTCM information is retrieved. The RTCM data is further defined by the RTCM rule (see the RTCMRULE command, Page 116).

The RTCMA log can be directly decoded by other NovAtel GPSCard receivers operating as remote stations. They will recognize the \$RTCM header as a special data input command and the differential corrections data will be directly applied. The GPSCard remote station receiving this log must have the ACCEPT command set to "ACCEPT port COMMANDS".

Structure:

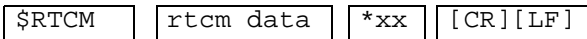

Field #	Field Type	Data Description	Example
1	\$RTCM	NovAtel format ASCII header	\$RTCM
2	rcm data	hexadecimal representation of binary format RTCM SC104 data	664142406B61455F565F7140607E5D526A5366C7C7F6F5A5B766D587D7F535C4B697F54594060685652625842707F77555B766558767F715B7746656B
3	*xx	Checksum	*54
4	[CR][LF]	Sentence terminator	[CR][LF]

Example:

```

$RTCM,664142406B61455F565F7140607E5D526A5366C7C7F6F5A5B766D587D7F535C4B697F54594060685652625842707F77555B766558767F715B7746656B*54[CR][LF]
    
```

RTCMB or RTCM1B

This log contains the same data available in the RTCM Standard Format Type 1 messages, but has been modified to allow flexibility in using the RTCM data. The RTCM data has been reformatted to be available in NovAtel Binary Format, utilizing a NovAtel binary header.

This message was designed so that RTCM data can be transmitted intermixed with other NovAtel binary data over a common communications port. The log is not in pure RTCM SC104 format and is not directly usable as such. GPSCard remote receivers cannot decode or interpret the RTCMB data (however, the GPSCard can directly interpret RTCM and RTCMA). The 12 byte NovAtel binary header must be stripped off before the RTCM information can be retrieved. The RTCM data is further defined by the RTCM rule (see the RTCMRULE command).

REMEMBER: Ensure that the RTCM rule is the same between all equipment.

Format: Message ID = 10 Message byte count = variable

Field #	Data	Bytes	Format	Offset
1 (header)	Sync	3	char	0
	Checksum	1	char	3
	Message ID	4	integer	4
	Message byte count	4	integer	8
2	RTCM SC104 data	variable		12

RTCM1A

Example:

```
$RTCM,597E7D7F716F745A647D7E42405273505276777C7F736C514E7D477A7F7F
5A7E6E62675F406C567F6753725B675F7B436A646A7D787F675D4A505056687C6B
567C7F5B69796F40547F73595557555546*51[CR][LF]
```

RTCM1B

Message ID = 10 Message byte count = variable

RTCM3 REFERENCE STATION PARAMETERS

RTK

This log contains the GPS position of the reference station expressed in rectangular ECEF coordinates based on the center of the WGS-84 ellipsoid. This log uses four RTCM data words following the two-word header, for a total frame length of six 30 bit words (180 bits maximum).

Structure:

(Follows the RTCM SC-104 Standard for a Type 3 message)

Type 3 messages contain the following information:

- Scale factor
- ECEF X-coordinate
- ECEF Y-coordinate
- ECEF Z-coordinate

The GPSCard only transmits the RTCM Type 3 message (RTCM3) when operating as a reference station paired with GPSCard remote receivers operating in RT-20 Carrier-Phase Mode (see *Appendix A, Page 63* for more information) or for RT-2, periodically transmitting an RTCM Type 18 and RTCM Type 19 (RTCM1819), or RTCM Type 22 message, together with an RTCM Type 3 (see *Page 19*).

NOTE: This log is intended for use when operating in RT-20 mode.

Example:

```
$RTCM3,597E7C7F7B76537A66406F49487F797B627A7A5978634E6E7C5155444946*68[CR][LF]
```

RTCM3B

Message ID = 41 Message byte count = 35 if RTCMRULE = 8 (12 bytes header, 23 bytes data)
= 42 if RTCMRULE = 6 (12 bytes header, 30 bytes data)

RTCM9 PARTIAL SATELLITE SET DIFFERENTIAL CORRECTIONS

RTCM Type 9 messages follow the same format as Type 1 messages. However, unlike Type 1 messages, Type 9's do not require a complete satellite set. This allows for much faster differential correction data updates to the remote stations, thus improving performance and reducing latency.

Type 9 messages should give better performance when SA rate correction variations are high, or with slow or noisy data links.

NOTE: The reference station transmitting the Type 9 corrections must be operating with a high-stability clock to prevent degradation of navigation accuracy due to the unmodeled clock drift that can occur between Type 9 messages.

NovAtel recommends a high-stability clock such as the PIEZO Model 2900082 whose 2-sample (Allan) variance meets the following stability requirements:

$3.24 \times 10^{-24} \text{ s}^2/\text{s}^2$ between 0.5 - 2.0 seconds, and

$1.69 \times 10^{-22} \text{ T s}^2/\text{s}^2$ between 2.0 - 100.0 seconds

An external clock such as an OCXO requires approximately 10 minutes to warm up and become fully stabilized after power is applied; do not broadcast RTCM Type 9 corrections during this warm-up period.

Structure: (Follows the RTCM Standard SC-104 for a Type 1 message)

Type 9 messages contain the following information for a group of three satellites in view at the reference station:

- Scale factor
- User Differential Range Error
- Satellite ID
- Pseudorange correction
- Range-rate correction
- Issue of Data (IOD)

RTCM9A

Example:

```
$RTCM9,66516277547C71435D797760704260596876655F7743585D547562716D7
57E686C5258*6D[CR][LF]
```

RTCM9B

Message ID = 42 Message byte count = variable

RTCM16 SPECIAL MESSAGE

This log contains a special ASCII message that can be displayed on a printer or cathode ray tube. The GPSCard reference station wishing to log this message out to remote stations must use the RTCM16T command to set the required ASCII text message. Once set, the message can then be issued at the required intervals with the “LOG port RTCM16 interval” command. If it is desired that only updated text messages be transmitted, then the GPSCard log interval must be either “onnew” or “onchanged”. The Special Message setting can be verified in the RCCA configuration log.

The RTCM16 data log follows the RTCM Standard Format. Words 1 and 2 contain RTCM header information followed by words 3 to n (where n is variable from 3 to 32) which contain the special message ASCII text. Up to 90 ASCII characters can be sent with each RTCM Type 16 message frame.

Structure: (Follows the RTCM Standard SC-104 for a Type 16 message)

RTCM16A

This message is the hexadecimal code equivalent of the special message entered using the RTCM16T command.

Example:

```
$RTCM16,6649404045495E5A5C406A58696D76596D5F665F765869694D4E53604D
70696552567E7B675762747B67576C574E596F59697146555A75516F5F667D4967
5656574E53604D55565A6D69647B67777E454659685D56465A67616E4B7E7F7F7D
*52[CR][LF]
```

RTCM16B

This message is the binary code equivalent of the special message entered using the RTCM16T command.

Message ID = 43 Message byte count = variable

RTCM16T

This message is used at the remote station to report the contents of a Type 16 message that was received from the reference station.

Structure:

\$RTCM16T	ASCII Special Message of up to 90 characters	*xx	[CR][LF]
-----------	--	-----	----------

Example:

```
$RTCM16T,Time flies like an arrow; fruit flies like a banana.*1F[CR][LF]
```

RTCM1819 UNCORRECTED CARRIER PHASE AND PSEUDORANGE MEASUREMENTS**RTK**

This log contains the raw carrier phase and raw pseudorange measurement information. The measurements are not corrected by the ephemerides contained in the satellite message. Word 3, the first data word after the header, contains a GPS TIME OF MEASUREMENT field which is used to increase the resolution of the MODIFIED Z-COUNT in the header. Word 3 is followed by pairs of words containing the data for each satellite observed. Appropriate flags are provided to indicate L1, L2, ionospheric free pseudorange or ionospheric difference carrier phase data, C/A or P-code, and half or full-wave L2 carrier phase measurements. The carrier smoothing interval for pseudoranges and pseudorange corrections is also furnished, for a total frame length of six 30 bit words (180 bits maximum).

Structure:

(Follows the RTCM SC-104 Standard for a Type 18 and Type 19 message)

For RT-2, you may periodically transmit an RTCM Type 18 and RTCM Type 19 (RTCM1819) together with an RTCM Type 3 message (see *Page 19*).

In some instances you may want to disable the RTCM1819 message from being received. An example of this may be when you want pseudorange differential, but your base station receiver is a non-NovAtel receiver that transmits a non-standard version of the RTCM1819 message which the NovAtel receiver cannot interpret correctly. The RTCM1819 message is received by default, but the following commands can be used to force the receiver to use or ignore the message:

```
RTKMODE USE_RTCM1819
RTKMODE IGNORE_RTCM1819
```

RTCM22 RTCM EXTENDED REFERENCE STATION PARAMETERS **RTK**

Message Type 22 provides firstly, a means of achieving sub-millimeter precision for base station coordinates in a kinematic application, and secondly, base station antenna height above a base, which enables mobile units to reference measured position to the base directly in real time.

The first data word of message Type 22 provides the corrections to be added to each ECEF coordinate. Note that the corrections may be positive or negative.

The second data word, which may not be transmitted, provides the antenna L1 phase center height expressed in integer and fractional centimeters, and is always positive. It has the same resolutions as the corrections. The range is about 10 meters. The spare bits can be used if more height range is required.

RTCM59 TYPE 59N-0 NOVATEL PROPRIETARY MESSAGE

RTK

RTCM Type 59 messages are reserved for proprietary use by RTCM reference station operators.

Each message is variable in length, limited only by the RTCM maximum of 990 data bits (33 words maximum). The first eight bits in the third word (the word immediately following the header) serve as the message identification code, in the event that the reference station operator wishes to have multiple Type 59 messages.

NovAtel has defined only a Type 59N-0 message to date; it is to be used for operation in GPSCard receivers capable of operating in RT-20 Carrier-Phase Differential Positioning Mode. This log is primarily used by a GPSCard reference station to broadcast its RT-20 observation data (delta pseudorange and accumulated doppler range) to remote RT-20 – capable GPSCard receivers.

NOTE 1: The CDSA/B log is very useful for monitoring the serial data link, as well as differential data decode success.

NOTE 2: This log is intended for use when operating in RT-20 mode.

RTCM59A

Example:

```
$RTCM59,665D43406E76576561674D7E7748775843757D4E646B545365647B7F48
657F504D4D6D425B657D5858606B617A737F7F7F464440727D7156577C65494F4D
4A60497F414D7E4272786D55534362406144705D764D596A7340654B6D5B464375
5848597C52705779466C*57[CR][LF]
```

RTCM59B

Message ID = 44 Message byte count = variable

RTCM RECEIVE ONLY DATA

The following RTCM data types can be received and decoded by the GPSCard, however these log types are no longer transmitted.

RTCM TYPE 2

Quite often a reference station may have new ephemeris data before remote stations have collected the newer ephemeris. The purpose of Type 2 messages is to act as a bridge between old and new ephemeris data. A reference station will transmit this Type 2 bridge data concurrently with Type 1's for a few minutes following receipt of a new ephemeris. The remote station adds the Type 2 data (delta of old ephemeris minus new ephemeris) to the Type 1 message data (new ephemeris) to calculate the correct pseudorange corrections (based on the old ephemeris). Once the remote receiver has collected its own updated ephemeris, it will no longer utilize the Type 2 messages.

The GPSCard will accept and decode RTCM Standard Type 2 messages, when available and if required. However, the GPSCard no longer transmits Type 2 messages.

Type 2 messages are variable in length, depending on the number of satellites being tracked by the reference station.

4.3 CMR FORMAT MESSAGING

The Compact Measurement Record (CMR) message format was developed by Trimble Navigation Ltd. as a proprietary data transmission standard for use in real-time kinematic applications. In 1996 Trimble publicly disclosed this standard and allowed its use by all manufacturers in the GPS industry³.

The NovAtel implementation allows a NovAtel rover receiver to operate in either RT-2 or RT-20 mode while

3. Talbot, N.C. (1996), "Compact Data Transmission Standard for High-Precision GPS". Proceeding of the ION GPS-96 Conference, Kansas City, MO, September 1996, Vol. I, pp. 861-871

receiving pseudorange and carrier phase data via CMR messages (versions 1.0, 2.0 or 3.0) from a non-NovAtel base-station receiver. The MiLLennium can also transmit CMR messages (version 3.0). The station ID, see *Page 100*, must be ≤ 31 when transmitting CMR corrections.

NOTE: No guarantee is made that the MiLLennium will meet its performance specifications if non-NovAtel equipment is used.

Using RT-2 or RT-20 with CMR Format Messages

To enable receiving CMR messages, follow these steps:

1. Issue the COMn command to the rover receiver to set its serial port parameters to the proper bit rate, parity, etc. This command is described in detail on *Page 86*.
2. Issue the “ACCEPT COMn CMR” command to the rover receiver, where “COMn” refers to either the COM1 or COM2 serial port that is connected to the data link.

Assuming that the base station is transmitting valid data, your rover receiver will now begin to operate in RT-2 or RT-20 mode. To send CMR messages, do the following:

Periodically transmit two CMR messages at the reference station (the station ID, see *Page 100*, must be ≤ 31):-

- A CMROBS message contains reference station satellite observation information, and should be sent once every 1 or 2 seconds.
- A CMRREF message contains reference station position information, and should be sent once every 10 seconds.

In addition to the logs which you can use to output the rover’s position (e.g. POSA/B, PRTKA/B, RTKA/B), the baseline (BSLA/B), and the reference station’s position and health (RPSA/B), you can also monitor the status of the incoming CMR messages using the CDSA/B (Communication and Differential Decode Status) log. See *Page 146* for a complete description of the CDSA/B log and its arguments.

4.4 RINEX FORMAT

The Receiver-Independent Exchange (RINEX) format is a broadly-accepted, receiver-independent format for storing GPS data. It features a non-proprietary ASCII file format that can be used to combine or process data generated by receivers made by different manufacturers. RINEX was originally developed at the Astronomical Institute of the University of Berne. Version 2, containing the latest major changes, appeared in 1990; subsequently, minor refinements were added in 1993. To date, there are three different RINEX file types. Each of the file types consists of a header section and a data section, and includes the following information⁴:

- observation files (carrier-phase measurements; pseudorange / code measurements; times of observations)
- broadcast navigation message files (orbit data for the satellites tracked; satellite clock parameters; satellite health condition; expected accuracy of pseudorange measurements; parameters of single-frequency ionospheric delay model; correction terms relating GPS time to UTC)
- meteorological data files (barometric pressure; dry air temperature; relative humidity; zenith wet tropospheric path delay; time tags)

NOTE: Although RINEX is intended to be a receiver-independent format, there are many optional records and fields. Please keep this in mind when combining NovAtel and non-NovAtel RINEX data.

4. For further information on RINEX Version 2 file descriptions, you may wish to consult relevant articles in scientific journal such as:
Gurtner, W.G. Mader (1990): “Receiver Independent Exchange Format Version 2.” CSTG GPS Bulletin Vol. 3 No. 3, Sept/Oct 1990, National Geodetic Survey, Rockville.

In support of the first two file types, NovAtel has created six ASCII log types that contain data records in RINEX format (XOBS, XOHD, XNAV, XNHD, XKIN, and XSTA). A seventh pseudo-log type (RINEX) can be used instead to simplify data collection. These logs produce multiple lines of output; each line ends with a NovAtel checksum. Once collected these logs should be processed into the 2 standard RINEX files using NovAtel's Convert utility.

A sample session, illustrating the use of the commands and logs, would be as follows:

```
COM1> log com2 rinex ontime 30
      (some time later - move to a new site)

COM1> log com2 xkin

COM1> rinex markernum 980.1.35

COM1> rinex antdh 3.1
      (at new site)

COM1> log com2 xsta
      (some time later - logging complete)

COM1> unlogall
```

It should be noted that the first line of this example is equivalent to these two lines:

```
COM1> log com2 xobs ontime 30
COM1> log com2 xnav onchanged
```

The use of the pseudo-log RINEX is for convenience only.

After the UNLOGALL command, the XNHD and XOHD logs are automatically generated if XNAV and XOBS, respectively, were active.

4.4.1 Commands

RINEX

This command is used to configure the user-defined fields in the file headers.

The settings of all these fields are visible in the RCCA log. All settings can be saved to non-volatile memory on a MiLLennium card by the SAVECONFIG command. A CRESET command will empty all text fields and reduce to zero the antenna offsets.

Syntax:

```
RINEX cfgtype
```

Command	Range Values	Description
RINEX	-	Command
cfgtype	AGENCY	Define agency name in observation log header
	ANTDE	Define antenna delta east (offset to marker) in observation log and static event log
	ANTDH	Define antenna delta height (offset to marker) in observation log and static event log
	ANTDN	Define antenna delta north (offset to marker) in observation log and static event log
	ANTNUM	Define antenna number in observation log header
	ANTTYPE	Define antenna type in observation log header
	COMMENT	Add comment to navigation and observation log headers (optional)
	MARKNAME	Define marker name in observation log and static event log
	MARKERNUM	Define marker number in observation log (optional) and static event log
	OBSERVER	Define observer name in observation log header
	RECNUM	Define receiver number in observation log header

Command example:

```
COM1> rinex agency NovAtel Surveying Service Ltd.
COM1> rinex antde -0.05
COM1> rinex antdh 2.7
COM1> rinex antdn 0.1
COM1> rinex antnum Field #1
COM1> rinex anttype NovAtel 501
COM1> rinex comment Field trial of new receiver
COM1> rinex markname A980
COM1> rinex markernum 980.1.34
COM1> rinex observer S.C. Lewis
COM1> rinex recnum LGN94100019
COM1> log com1 rcca
```

Log example:

```
$RCCA,COM1,9600,N,8,1,N,OFF,OFF*65
... etc....
$RCCA,RINEX,COMMENT,Field trial of new receiver*68
$RCCA,RINEX,AGENCY,NovAtel Surveying Service Ltd.*5A
$RCCA,RINEX,MARKNAME,A980*15
$RCCA,RINEX,MARKERNUM,980.1.34*24
$RCCA,RINEX,OBSERVER,S.C. Lewis*0B
$RCCA,RINEX,RECNUM,LGN94100019*34
$RCCA,RINEX,ANTNUM,Field #1*0A
$RCCA,RINEX,ANTTYPE,NovAtel 501*4B
$RCCA,RINEX,ANTDN,0.100*09
$RCCA,RINEX,ANTDE,-0.050*2B
$RCCA,RINEX,ANTDH,2.700*0B
```

Note that the RCCA log shows any non-default RINEX settings.

4.4.2 Logs

RINEX OBSERVATION AND NAVIGATION LOGS AND HEADERS

This pseudo - log type exists to simplify the commands for the user. For example, at the command

```
COM1> log com2 rinex ontime 30
```

the XOBS and XNAV logs are both started. When it is time to cease data collection, the command

```
COM1> unlog com2 rinex
```

or

```
COM1> unlogall
```

will stop the XOBS and XNAV logs, and the XNHD and XOHD logs will be generated once.

XKIN OBSERVATION KINEMATIC EVENT

This log generates a time tag and flag to indicate when antenna motion begins.

Command example:

```
COM1> log com2 xkin
```

Log example:

```
$XOBS, 96 04 10 17 25 19.5000000 2*00
$XOBS,                                     4 1*2F
$XOBS, *** KINEMATIC DATA FOLLOWS ***      COMMENT*50
```

XNAV NAVIGATION DATA RECORD

This log type contains broadcast navigation message records for each satellite being used. Each set of records consists of:

- orbit data for the satellites tracked
- satellite clock parameters
- satellite health condition
- expected accuracy of pseudorange measurements
- parameters of single-frequency ionospheric delay model
- correction terms relating GPS time to UTC

Command example:

```
COM1> log com2 xnav unchanged
```

Log example:

```
$XNAV,22 96 04 10 18 00 0.0 .2988767810166D-03 .2842170943040D-11 .000000000000D+00*77
$XNAV,.157000000000D+03 .516250000000D+02 .4851987819054D-08 -.307153354042D+01*10
$XNAV,.2656131982803D-05.8917320519686D-02.9054318070412D-05 .5153725172043D+04*01
$XNAV, .324000000000D+06 -.149011611938D-06 .1649994199967D+01 .1117587089539D-07*1E
$XNAV,.9465553285374D+00 .199281250000D+03 .4627841719040D-01 -.806355016494D-08*17
$XNAV,-.175721605224D-09 .100000000000D+01 .848000000000D+03 .000000000000D+00*18
$XNAV,.700000000000D+01 .000000000000D+00 .1396983861923D-08 .413000000000D+03*08
$XNAV,.317076000000D+06*5E
```

XNHD NAVIGATION HEADER

This log consists of a RINEX-format header for broadcast navigation message files. It can be generated at any point, using a command such as

```
COM1> log com2 xnhd
```

or it will be generated automatically when logging is complete, using a command such as

```
COM1> unlogall
```

Log example:

```
$XNHD, 2 NAVIGATION DATA RINEX VERSION / TYPE*3B
$XNHD, NovAtel GPSCard NATIVE 96-04-10 16:13 PGM / RUN BY / DATE*05
$XNHD,Field trial of new receiver COMMENT*29
$XNHD,.10245D-07 .14901D-07 -.5960D-07 -.1192D-06 ION ALPHA*05
$XNHD,.88064D+05 .32768D+05 -.1966D+06 -.1966D+06 ION BETA*46
$XNHD, .9313225746155D-09 -.799360577730D-14 503808 848 DELTA-UTC: A0,A1,T,W*3C
$XNHD, 11 LEAP SECONDS*4D
$XNHD, END OF HEADER*6F
```

XOBS OBSERVATION DATA RECORD

This log contains observation records, which include the following information:

- Times of observations
- Carrier-phase measurements
- Pseudorange (code) measurements
- Doppler measurements

A set of observation records is generated at the end of every time interval specified.

Command example:

```
COM1> log com2 xobs ontime 5
```

Log example:

```
$XOBS, 96 04 10 16 12 45.0000000 0 10G22G29G 3G28G16G27G 2G18G31G19*2B
$XOBS,          25589487.514 1 134473357.195 11 3689.020 1*20
$XOBS,          24031521.036 7 126285967.262 7 3673.582 7*3E
$XOBS,          22439789.377 9 117921029.600 9 270.081 9*2A
$XOBS,          22766999.777 9 119640447.360 9 924.831 9*28
$XOBS,          23387648.507 6 122901958.756 6 -640.482 6*2F
$XOBS,          21889019.606 8 115027300.270 8 -2682.420 8*3D
$XOBS,          24678340.269 7 129684455.444 7 -3295.920 7*3D
$XOBS,          21218703.216 9 111503905.438 9 2528.269 9*30
$XOBS,          21855014.913 9 114847991.342 9 -1951.670 9*33
$XOBS,          20157467.672 9 105927196.398 9 -688.169 9*2B
```

XOHD OBSERVATION HEADER

This log consists of a RINEX-format header for observation message files. It can be generated at any point, using a command such as

```
COM1> log com2 xohd
```

or it will be generated automatically when logging is complete, using a command such as

```
COM1> unlogall
```

Log example:

```
$XOHD, 2 OBSERVATION DATA G (GPS) RINEX VERSION / TYPE*50
$XOHD,NovAtel GPSCard NATIVE 96-04-10 16:04 PGM / RUN BY / DATE*02
$XOHD,Field trial of new receiver COMMENT*08
$XOHD,A980 MARKER NAME*62
$XOHD,980.1.34 MARKER number*11
$XOHD,S.C. Lewis NovAtel Surveying Service Ltd. OBSERVER / AGENCY*49
$XOHD,LGN94100019 GPSCard-2 FRASER 3.41RC12 REC # / TYPE / VERS*5F
$XOHD,Field #1 NovAtel 501 ANT # / TYPE*77
$XOHD, -1634937.3828 -3664677.1214 4942285.1723 APPROX POSITION XYZ*67
$XOHD, 2.7000 0.0500 0.1000 ANTENNA: DELTA H/E/N*56
$XOHD, 1 0 7 G 2 G 3 G16 G18 G19 G22 G27 WAVELENGTH FACT L1/2*2D
$XOHD, 1 0 3 G28 G29 G31 WAVELENGTH FACT L1/2*28
$XOHD, 3 C1 L1 D1 # / TYPES OF OBSERV*0F
$XOHD, 5 INTERVAL*3D
$XOHD, 1996 4 10 16 4 43.150000 TIME OF FIRST OBS*03
$XOHD, 1996 4 10 16 13 0.000000 TIME OF LAST OBS*56
$XOHD, 10 # OF SATELLITES*14
$XOHD, G 2 101 101 101 PRN / # OF OBS*45
$XOHD, G 3 101 101 101 PRN / # OF OBS*44
$XOHD, G16 101 101 101 PRN / # OF OBS*50
$XOHD, G18 101 101 101 PRN / # OF OBS*5E
$XOHD, G19 101 101 101 PRN / # OF OBS*5F
$XOHD, G22 101 101 101 PRN / # OF OBS*57
$XOHD, G27 101 101 101 PRN / # OF OBS*52
$XOHD, G28 101 101 101 PRN / # OF OBS*5D
$XOHD, G29 101 101 101 PRN / # OF OBS*5C
$XOHD, G31 101 101 101 PRN / # OF OBS*55
$XOHD, END OF HEADER*6E
```

XSTA OBSERVATION STATIC EVENT

This log generates a time tag and flag when a new site occupation begins.

Command example:

```
COM1> log com2 xsta
```

Log example:

```
$XOBS, 96 04 10 17 25 45.0000000 3 4*39
$XOBS,A980
$XOBS,980.1.35
$XOBS,          3.1000          0.0500          0.1000
$XOBS, *** NEW SITE OCCUPATION ***
MARKER NAME*7F
MARKER number*0D
ANTENNA: DELTA H/E/N*4C
COMMENT*19
```

A

GPS OVERVIEW

The Global Positioning System (GPS) is a satellite navigation system capable of providing a highly accurate, continuous global navigation service independent of other positioning aids. GPS provides 24-hour, all-weather, worldwide coverage with position, velocity and timing information.

The system uses the NAVSTAR (NAVigation Satellite Timing And Ranging) satellites which consists of 24 operational satellites to provide a GPS receiver with a six to twelve-satellite coverage at all times depending on the model. A minimum of four satellites in view allows the GPSCard to compute its current latitude, longitude, altitude with reference to mean sea level and the GPS system time.

Figure A-1 NAVSTAR Satellite Orbit Arrangement

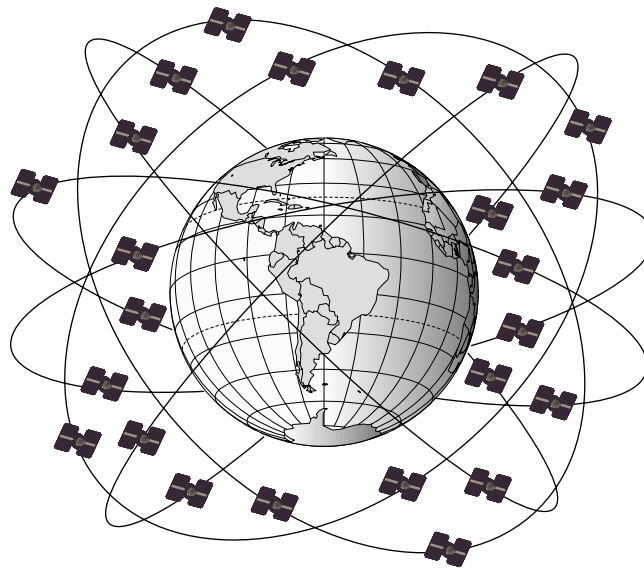

A.1 GPS SYSTEM DESIGN

The GPS system design consists of three parts:

- The Space segment
- The Control segment
- The User segment

All these parts operate together to provide accurate three dimensional positioning, timing and velocity data to users worldwide.

The Space Segment

The space segment is composed of the NAVSTAR GPS satellites. The final constellation of the system consists of 24 satellites in six 55° orbital planes, with four satellites in each plane. The orbit period of each satellite is approximately 12 hours at an altitude of 10,898 nautical miles. This provides a GPS receiver with six to twelve satellites in view from any point on earth, at any particular time.

The GPS satellite signal identifies the satellite and provides the positioning, timing, ranging data, satellite status and the corrected ephemerides (orbit parameters) of the satellite to the users. The satellites can be identified either by the Space Vehicle Number (SVN) or the Pseudorandom Code Number (PRN). The PRN is used by the NovAtel

GPSCard.

The GPS satellites transmit on two L-band frequencies; one centered at 1575.42 MHz (L1) and the other at 1227.60 MHz (L2). The L1 carrier is modulated by the C/A code (Coarse/Acquisition) and the P code (Precision) which is encrypted for military and other authorized users. The L2 carrier is modulated only with the P code.

The Control Segment

The control segment consists of a master control station, five reference stations and three data up-loading stations in locations all around the globe.

The reference stations track and monitor the satellites via their broadcast signals. The broadcast signals contain the ephemeris data of the satellites, the ranging signals, the clock data and the almanac data. These signals are passed to the master control station where the ephemerides are re-computed. The resulting ephemerides corrections and timing corrections are transmitted back to the satellites via the data up-loading stations.

The User Segment

The user segment, such as the NovAtel GPSCard receiver, consists of equipment which tracks and receives the satellite signals. The user equipment must be capable of simultaneously processing the signals from a minimum of four satellites to obtain accurate position, velocity and timing measurements. A user can also use the data provided by the satellite signals to accomplish specific application requirements.

A.2 HEIGHT RELATIONSHIPS

What is a geoid?

The equipotential surface which best represents mean sea level where an equipotential surface is any surface where gravity is constant. This surface not only covers the water but is projected throughout the continents. Most surfaces in North America use this surface as its zero value, i.e. all heights are referenced to this surface.

What is an ellipsoid?

An ellipsoid, also known as a spheroid, is a mathematical surface which is sometimes used to represent the earth. Whenever you see latitudes and longitudes describing the location, this coordinate is being referenced to a specific ellipsoid. GPS positions are referred to an ellipsoid known as WGS84 (World Geodetic System of 1984).

What is the relationship between a geoid and an ellipsoid?

The relationship between a geoid and an ellipsoid is shown in *Figure A-2*.

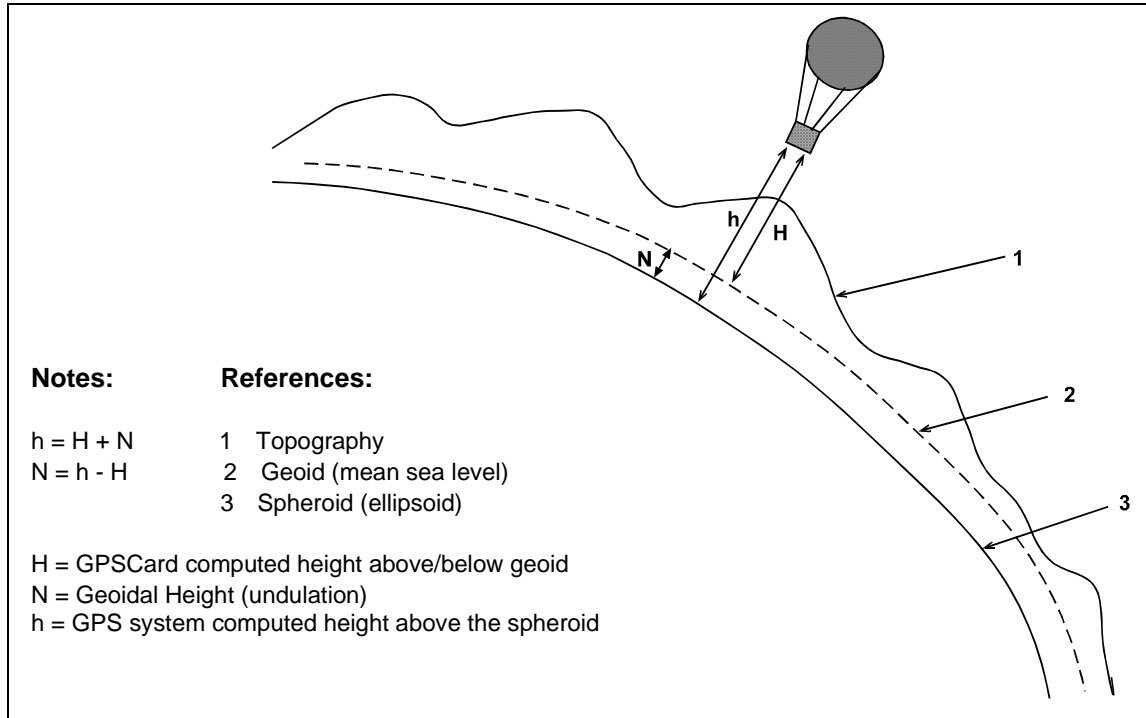
Figure A-2 Illustration of GPSCard Height Measurements

From the above diagram, and the formula $h = H + N$, to convert heights between the ellipsoid and geoid we require the geoid-ellipsoid separation value. This value is not easy to determine. A world-wide model is generally used to provide these values. NovAtel GPS receivers store this value internally. This model can also be augmented with local height and gravity information. A more precise geoid model is available from government survey agencies e.g. U.S. National Geodetic Survey or Geodetic Survey of Canada (refer to *Appendix F, Standards and References*).

Why is this important for GPS users?

The above formula is critical for GPS users as they typically obtain ellipsoid heights and need to convert these into mean sea level heights. Once this conversion is complete, users can relate their GPS derived heights to more "usable" mean sea-level heights.

A.3 GPS POSITIONING

GPS positioning can be categorized as follows:

1. single-point or relative
2. static or kinematic
3. real-time or post-mission data processing

A distinction should be made between *accuracy* and *precision*. *Accuracy* refers to how close an estimate or measurement is to the true but unknown value; *precision* refers to how close an estimate is to the mean (average) estimate. *Figure A-3* illustrates various relationships between these two parameters: the true value is "located" at the intersection of the cross-hairs, the centre of the shaded area is the "location" of the mean estimate, and the radius of the shaded area is a measure of the uncertainty contained in the estimate.

Figure A-3 Accuracy versus Precision⁵

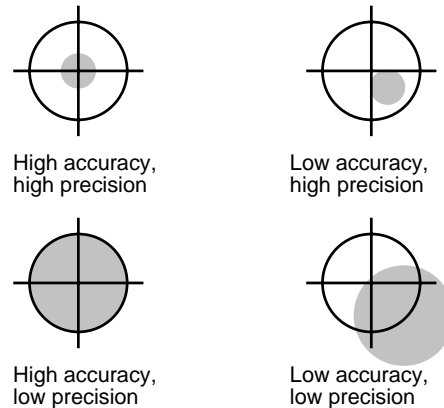

Single-point vs. Relative Positioning

In *single-point* positioning, coordinates of a GPS receiver at an unknown location are sought with respect to the earth's reference frame by using the known positions of GPS satellites being tracked. The position solution generated by the receiver is initially developed in earth-centered coordinates which can subsequently be converted to any other coordinate system. With as few as four GPS satellites in view, the absolute position of the receiver in three-dimensional space can be determined. Only one receiver is needed. With Selective Availability (SA) active, the typical horizontal accuracy obtainable using single-point positioning is of the order of 100 m (95% of the time).

In *relative* positioning, also known as *differential* positioning, the coordinates of a GPS receiver at an unknown point (the "remote" station) are sought with respect to a GPS receiver at a known point (the "reference" station). The concept is illustrated in *Figure A-4*. The relative-position accuracy of two receivers locked on the same satellites and not far removed from each other - up to tens of kilometers - is extremely high. The largest error contributors in single-point positioning are those associated with SA and atmospheric-induced effects. These errors, however, are highly correlated for adjacent receivers and hence cancel out in relative measurements. Since the position of the reference station can be determined to a high degree of accuracy using conventional surveying techniques, any differences between its known position and the position computed using GPS techniques can be attributed to various components of error as well as the receiver's clock bias. Once the estimated clock bias is removed, the remaining error on each pseudorange can be determined. The reference station sends information about each satellite to the remote station, which in turn can determine its position much more exactly than would be possible otherwise.

The advantage of relative positioning is that much greater precision (presently as low as 2 mm, depending on the method and environment) can be achieved than by single-point positioning. In order for the observations of the reference station to be integrated with those of the remote station, relative positioning requires either a data link between the two stations (if the positioning is to be achieved in real-time) or else post-processing of the data collected by the remote station. At least four GPS satellites in view are still required. The absolute accuracy of the remote station's computed position will depend on the accuracy of the reference station's position.

5. Environment Canada, 1993, Guideline for the Application of GPS Positioning, p. 22.
© Minister of Supply and Services Canada

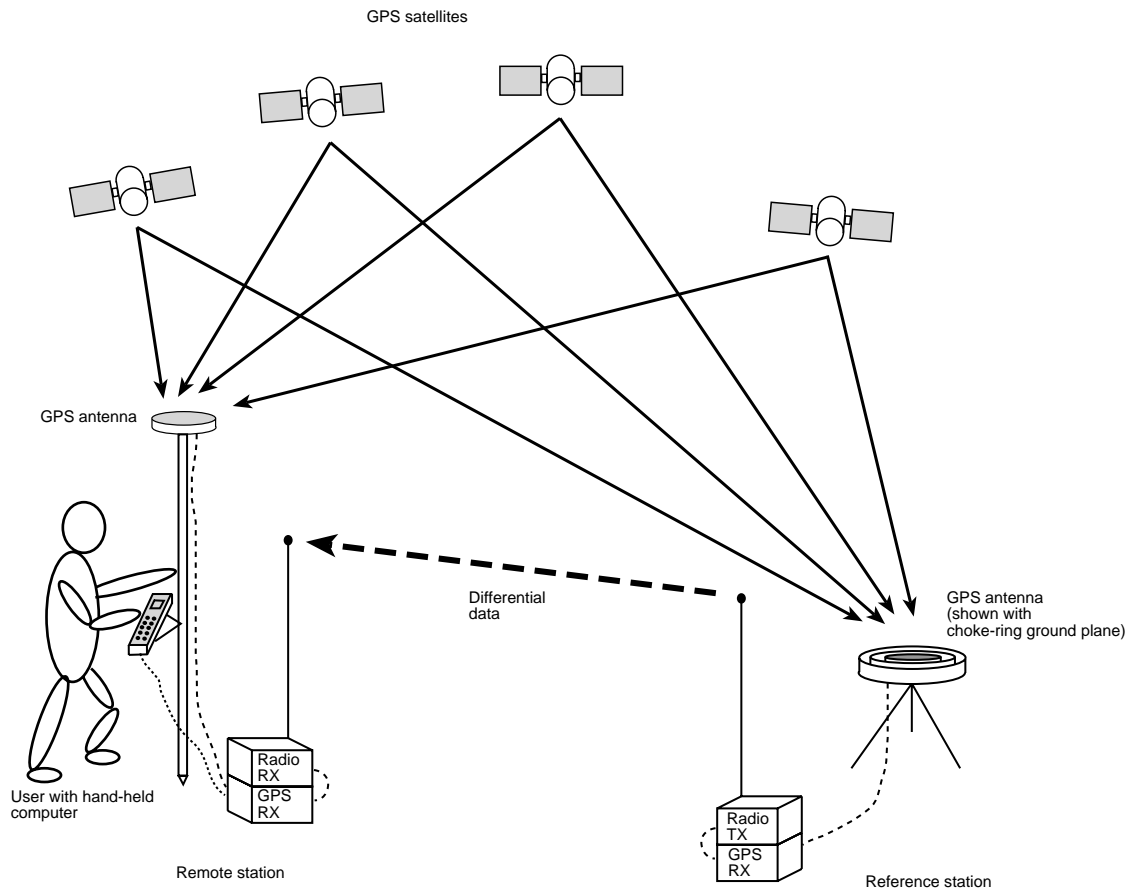
Figure A-4 Example of Differential Positioning

Static vs. Kinematic Positioning

Static and *kinematic* positioning refer to whether a GPS receiver is stationary or in motion while collecting GPS data.

Real-time vs. Post-mission Data Processing

Real-time or *post-mission* data processing refer to whether the GPS data collected by the receiver is processed as it is received or after the entire data-collection session is complete.

Differential Positioning

There are two types of differential positioning algorithms: *pseudorange* and *carrier phase*. In both of these approaches, the “quality” of the positioning solution generally increases with the number of satellites which can be simultaneously viewed by both the reference and remote station receivers. As well, the quality of the positioning solution increases if the distribution of satellites in the sky is favorable; this distribution is quantified by a figure of merit, the Position Dilution of Precision (PDOP), which is defined in such a way that the lower the PDOP, the better the solution.

Due to the many different applications for differential positioning systems, two types of position solutions are possible. NovAtel’s carrier-phase algorithms can generate both *matched* and *low-latency* position solutions, while NovAtel’s pseudorange algorithms generate only low-latency solutions. These are described below:

1. The *matched* position solution is computed at the remote station when the observation information for a given epoch has arrived from the reference station via the data link. Matched observation set pairs are observations by both the reference and remote stations which are matched by time epoch, and contain the same satellites. The matched position solution is the most accurate one available to the operator of the remote station, but it has an inherent *latency* – the sum of time delays between the moment that the reference station makes an observation and the moment that the differential information is processed at the remote station. This latency depends on the computing speed of the reference station receiver, the rates at which data is transmitted through the various links, and the computing speed of the remote station; the overall delay is of the order of one second. Furthermore, this position cannot be computed any more often than the observations are sent from the reference station. Typically, the update rate is one solution every two seconds.
2. The *low latency* (or *extrapolated*) position solution is based on a prediction. Instead of waiting for the observations to arrive from the reference station, a model (based on previous reference station observations) is used to estimate what the observations will be at a given time epoch. These estimated reference station observations are combined with actual measurements taken at the remote station to provide the position solution. Because only the reference station observations are predicted, the remote station's dynamics will be accurately reflected. The *latency* in this case (the time delay between the moment that a measurement is made by the remote station and the moment that a position is made available) is determined only by the remote processor's computational capacity; the overall delay is of the order of 100 ms. Low-latency position solutions can be computed more often than matched position solutions; the update rate can reach 10 solutions per second. The low-latency positions will be provided for data gaps between matched positions of up to 30 seconds (for a carrier-phase solution) or 60 seconds (for a pseudorange solution, unless adjusted using the DGPSTIMEOUT command). A general guideline for the additional error incurred due to the extrapolation process is shown in *Table 1-2*.

Pseudorange Algorithms

Pseudorange algorithms correlate the pseudorandom code on the GPS signal received from a particular satellite, with a version generated within the reference station receiver itself. The time delay between the two versions, multiplied by the speed of light, yields the *pseudorange* (so called because it contains several errors) between the reference station and that particular satellite. The availability of four pseudoranges allows the reference station receiver to compute its position (in three dimensions) and the offset required to synchronize its clock with GPS system time. The discrepancy between the reference station receiver's computed position and its known position is due to errors and biases on each pseudorange. The reference station receiver sums these errors and biases for each pseudorange, and then broadcasts these corrections to the remote station. The remote receiver applies the corrections to its own measurements; its corrected pseudoranges are then processed in a least-squares algorithm to obtain a position solution.

The "wide correlator" receiver design that predominates in the GPS industry yields accuracies of 3-5 m (SEP). NovAtel's patented Narrow Correlator tracking technology reduces noise and multipath interference errors, yielding accuracies of 1 m (SEP).

Pseudorange Differential Positioning

GPS SYSTEM ERRORS

In general, GPS SPS C/A code single point pseudorange positioning systems are capable of absolute position accuracies of about 100 meters or less. This level of accuracy is really only an estimation, and may vary widely depending on numerous GPS system biases, environmental conditions, as well as the GPS receiver design and engineering quality.

There are numerous factors which influence the single point position accuracies of any GPS C/A code receiving system. As the following list will show, a receiver's performance can vary widely when under the influences of these combined system and environmental biases.

- **Ionospheric Group Delays** – The earth’s ionospheric layers cause varying degrees of GPS signal propagation delay. Ionization levels tend to be highest during daylight hours causing propagation delay errors of up to 30 meters, whereas night time levels are much lower and may be up to 6 meters.
- **Tropospheric Refraction Delays** – The earth’s tropospheric layer causes GPS signal propagation delays which bias the range measurements. The amount of delay is at the minimum (about three metres) for satellite signals arriving from 90 degrees above the horizon (overhead), and progressively increases as the angle above the horizon is reduced to zero where delay errors may be as much as 50 metres at the horizon.
- **Ephemeris Errors** – Some degree of error always exists between the broadcast ephemeris’ predicted satellite position and the actual orbit position of the satellites. These errors will directly affect the accuracy of the range measurement.
- **Satellite Clock Errors** – Some degree of error also exists between the actual satellite clock time and the clock time predicted by the broadcast data. This broadcast time error will cause some bias to the pseudorange measurements.
- **Receiver Clock Errors** – Receiver clock error is the time difference between GPS receiver time and true GPS time. All GPS receivers have differing clock offsets from GPS time that vary from receiver to receiver by an unknown amount depending on the oscillator type and quality (TCXO VS. OCXO, etc.). However, because a receiver makes all of its single point pseudorange measurements using the same common clock oscillator, all measurements will be equally offset, and this offset can generally be modeled or quite accurately estimated to effectively cancel the receiver clock offset bias. Thus, in single point positioning, receiver clock offset is not a significant problem. However, in pseudorange differential operation, between-receiver clock offset is a source of uncorrelated bias.
- **Selective Availability (SA)** – Selective availability is when the GPS Control Segment intentionally corrupts satellite clock timing and broadcast orbit data to cause reduced positioning accuracy for general purpose GPS SPS users (non-military). When SA is active, range measurements may be biased by as much as 30 metres.

NovAtel’s MiLLennium GPSCard is a civilian dual-frequency GPS receiver that normally tracks:

- L1 C/A Code
- L1 Carrier Phase
- L2 Semi-Codeless P Code
- L2 Carrier Phase

If anti-spoofing (AS) is ever dropped by the GPS Control Segment, then the OEM4 GPSCard will automatically begin tracking the L2 P Code:

- L1 C/A Code
- L1 Carrier Phase
- L2 P Code
- L2 Carrier Phase

P Code is never tracked on L1 even when AS is dropped.

- **Multipath Signal Reception** – Multipath signal reception can potentially cause large pseudorange and carrier phase measurement biases. Multipath conditions are very much a function of specific antenna site location versus local geography and man-made structural influences. Severe multipath conditions could skew range measurements by as much as 100 meters or more. See *Appendix B, Multipath Elimination Technology, Page 75* for more information.

The NovAtel GPSCard receivers are capable of absolute single point positioning accuracies of 15 meters CEP

(GDOP < 2; no multipath) when SA is off and 40 meters CEP while AS is on. (As the status of selective availability is generally unknown by the real-time GPS user, the positioning accuracy should be considered to be that of when AS is on).

The general level of accuracy available from single point operation may be suitable for many types of positioning such as ocean going vessels, general aviation, and recreational vessels that do not require position accuracies of better than 100 meters CEP. However, increasingly more and more applications desire and require a much higher degree of accuracy and position confidence than is possible with single point pseudorange positioning. This is where differential GPS (DGPS) plays a dominant role in higher accuracy real-time positioning systems.

SINGLE POINT AVERAGING WITH THE GPSCARD

By averaging many GPS measurement epochs over several hours, it is possible to achieve an absolute position based on the WGS-84 datum to better than five meters. This section attempts to explain how the position averaging function operates and to provide an indication of the level of accuracy that can be expected versus total averaging time.

The POSAVE command implements position averaging for reference stations. Position averaging will continue for a specified number of hours or until the averaged position is within specified accuracy limits. Averaging will stop when the time limit or the horizontal standard deviation limit or the vertical standard deviation limit is achieved. When averaging is complete, the FIX POSITION command will automatically be invoked.

If the maximum time is set to 1 hour or larger, positions will be averaged every 10 minutes and the standard deviations reported in the PAVA/B log should be correct. If the maximum time is set to less than 1 hour, positions will be averaged once per minute and the standard deviations reported in the log will likely not be accurate; also, the optional horizontal and vertical standard deviation limits cannot be used.

If the maximum time that positions are to be measured is set to 24, for example, you can then log PAVA with the trigger 'onchanged' to see the averaging status. i.e.,

```
posave 24
log com1 pava onchanged
```

You could initiate differential logging, then issue the POSAVE command followed by the SAVECONFIG command. This will cause the GPSCard to average positions after every power-on or reset, then invoke the FIX POSITION command to enable it to send differential corrections.

The position accuracy that may be achieved by these methods will be dependent on many factors: average satellite geometry, sky visibility at antenna location, satellite health, time of day, etc. The following graph summarizes the results of several examples of position averaging over different time periods. The intent is to provide an idea of the relationship between averaging time and position accuracy. All experiments were performed using a single frequency receiver with an ideal antenna location, see *Figure A-5*.

Figure A-5 Single Point Averaging

NOTE: This graph represents typical results using position averaging.

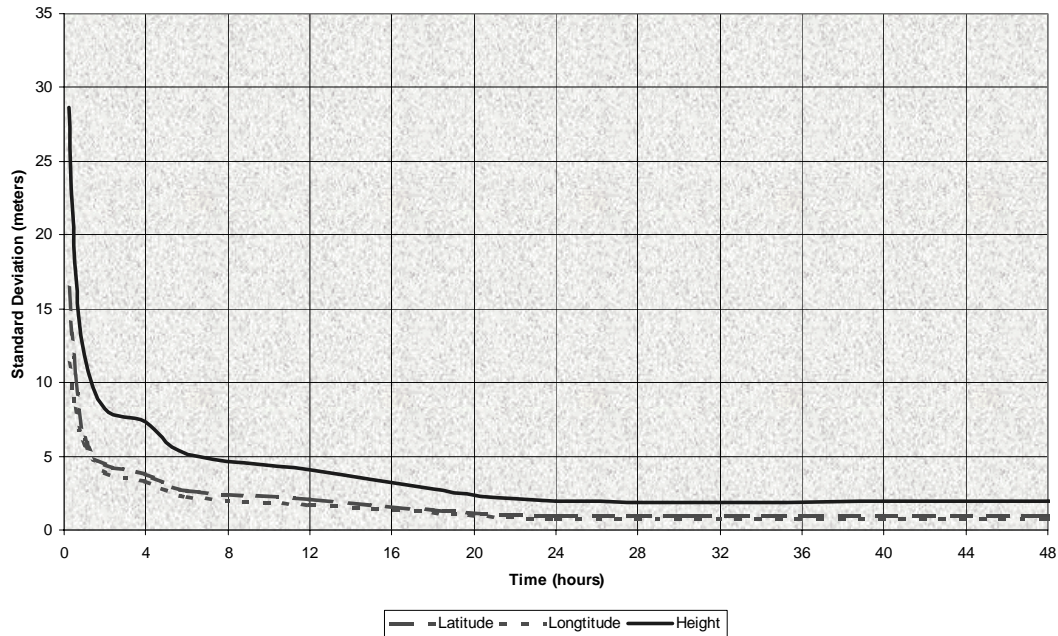

This function is useful for obtaining the WGS84 position of a point to a reasonable accuracy without having to implement differential GPS. It is interesting to note that even a six hour occupation can improve single point GPS accuracy from over fifty meters to better than five meters. This improved accuracy is primarily due to the reductions of the multipath and selective availability errors in the GPS signal.

Again, it is necessary to keep in mind that the resulting standard deviations of the position averaging can vary quite a bit, especially over relatively short averaging times. To illustrate, the position averaging function was run for a period of one hour at three different times during the day. The resulting standard deviation in latitude varied from 4.7 to 7.0 meters. Similarly, the variation in longitude and height were 4.9 to 6.7 meters and 10.9 to 12.5 meters respectively. This degree of variation is common for averaging periods of less than 12 hours due to changes in the satellite constellation. The graph, however, should at least provide some indication of the accuracy one may expect from single point position averaging.

Dual Station Differential Positioning

It is the objective of operating in differential mode to either eliminate or greatly reduce most of the errors introduced by the above types of system biases. Pseudorange differential positioning is quite effective in largely removing most of the biases caused by satellite clock error, ionospheric and tropospheric delays (for baselines less than 50 km), ephemeris prediction errors, and SA. However, the biases caused by multipath reception and receiver clock offset are uncorrelated between receivers and thus cannot be cancelled by "between receiver single differencing" operation.

Differential operation requires that stations operate in pairs. Each pair consists of a reference station (or control station) and a remote station. A differential network could also be established when there is more than one remote station linked to a single reference station.

In order for the differential pair to be effective, differential positioning requires that both reference and remote station receivers track and collect satellite data simultaneously from common satellites. When the two stations are in relatively close proximity (< 50 km), the pseudorange bias errors are considered to be nearly the same and can be effectively cancelled by the differential corrections. However, if the baseline becomes excessively long, the bias errors begin to decorrelate, thus reducing the accuracy or effectiveness of the differential corrections.

Figure A-6 Typical Differential Configuration

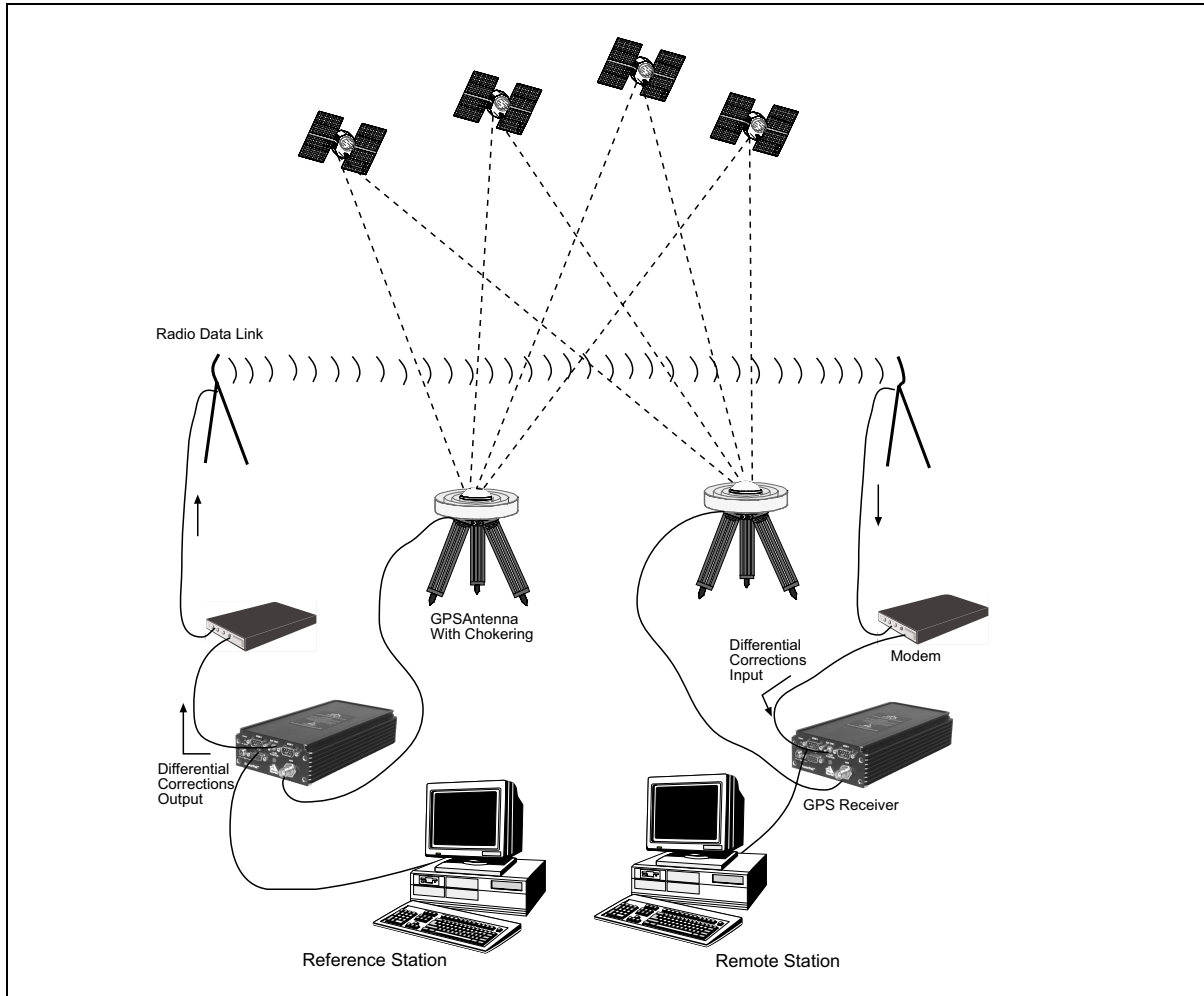

THE REFERENCE STATION

The nucleus of the differential network is the reference station. To function as a base station, the GPS receiver antenna must be positioned at a control point whose position is precisely known in the GPS reference frame. Typically, the fixed position will be that of a geodetic marker or a pre-surveyed point of known accuracy.

The reference receiver must then be initialized to fix its position to agree with the latitude, longitude, and height of the phase centre of the reference station GPS receiver antenna. Of course, the antenna offset position from the marker must be accurately accounted for.

Because the reference station's position is fixed at a known location, it can now *compute* the range of its known position to the satellite. The reference station now has two range measurements with which to work: *computed pseudoranges* based on its known position relative to the satellite, and *measured pseudoranges* which assumes the receiver position is unknown. Now, the reference station's measured pseudorange (unknown position) is differenced against the computed range (based on known position) to derive the differential correction which represents the difference between known and unknown solutions for the same antenna. This difference between the two ranges represents the combined pseudorange measurement errors resulting from receiver clock errors, atmospheric delays, satellite clock error, orbital errors, and SA.

The reference station will derive pseudorange corrections for each satellite being tracked. These corrections can now be transmitted over a data link to one or more remote stations. It is important to ensure that the reference station's FIX POSITION setting be as accurate as possible, as any errors here will directly bias the pseudorange corrections computed, and can cause unpredictable results depending on the application and the size of the base station position errors. As well, the reference station's pseudorange measurements may be biased by multipath reception.

THE REMOTE STATION

A remote station is generally any receiver whose position is of unknown accuracy, but has ties to a reference station through an established data link. If the remote station is not receiving differential corrections from the reference station, it is essentially utilizing single point positioning measurements for its position solutions, thus is subject to the various GPS system biases. However, when the remote GPS receiver is receiving a pseudorange correction from the reference station, this correction is algebraically summed against the local receiver's measured pseudorange, thus effectively cancelling the effects of orbital and atmospheric errors (assuming baselines < 50 km), as well as eliminating satellite clock error.

The remote must be tracking the same satellites as the reference in order for the corrections to take effect. Thus, only common satellites will utilize the differential corrections. When the remote is able to compute its positions based on pseudorange corrections from the reference station, its position accuracies will approach that of the reference station. Remember, the computed position solutions are always that of the GPS receiving antenna phase centre.

A.4 CARRIER-PHASE ALGORITHMS

Carrier-phase algorithms monitor the actual carrier wave itself. These algorithms are the ones used in real-time kinematic (RTK) positioning solutions - differential systems in which the remote station, possibly in motion, requires reference-station observation data in real-time. Compared to pseudorange algorithms, much more accurate position solutions can be achieved: carrier-based algorithms can achieve accuracies of 1-2 cm (CEP).

A carrier-phase measurement is also referred to as an *accumulated delta range* (ADR). At the L1 frequency, the wavelength is 19 cm; at L2, it is 24 cm. The instantaneous distance between a GPS satellite and a receiver can be thought of in terms of a number of wavelengths through which the signal has propagated. In general, this number has a fractional component and an integer component (such as 124 567 967.330 cycles), and can be viewed as a pseudorange measurement (in cycles) with an initially unknown constant integer offset. Tracking loops can compute the fractional component and the change in the integer component with relative ease; however, the determination of the initial integer portion is less straight-forward and, in fact, is termed the *ambiguity*.

In contrast to pseudorange algorithms where only corrections are broadcast by the reference station, carrier-phase algorithms typically "double difference" the actual observations of the reference and remote station receivers. Double-differenced observations are those formed by subtracting measurements between identical satellite pairs on two receivers:

$$\text{ADR}_{\text{double difference}} = (\text{ADR}_{\text{rx A,sat i}} - \text{ADR}_{\text{rx A,sat j}}) - (\text{ADR}_{\text{rx B,sat i}} - \text{ADR}_{\text{rx B,sat j}})$$

An ambiguity value is estimated for each double-difference observation. One satellite is common to every satellite pair; it is called the *reference* satellite, and it is generally the one with the highest elevation. In this way, if there are n satellites in view by both receivers, then there will be $n-1$ satellite pairs. The difference between receivers A and B removes the correlated noise effects, and the difference between the different satellites removes each receiver's clock bias from the solution.

In the NovAtel RTK system, a *floating* (or “*continuous-valued*”) *ambiguity solution* is continuously generated from a Kalman filter. When possible, *fixed-integer ambiguity solutions* are also computed because they are more accurate, and produce more robust standard-deviation estimates. Each possible discrete ambiguity value for an observation defines one *lane*; that is, each lane corresponds to a possible pseudorange value. There are a large number of possible lane combinations, and a receiver has to analyze each possibility in order to select the correct one. For single-frequency receivers, there is no alternative to this brute-force approach. However, one advantage of being able to make both L1 and L2 measurements is that linear combinations of the measurements made at both frequencies lead to additional values with either “wider” or “narrower” lanes. Fewer and wider lanes make it easier for the software to choose the correct lane, having used the floating solution for initialization. Once the correct *wide lane* has been selected, the software searches for the correct *narrow* lane. Thus, the searching process can more rapidly and accurately home in on the correct lane when dual-frequency measurements are available. Changes in the geometry of the satellites aids in ambiguity resolution; this is especially noticeable in L1-only solutions. In summary, NovAtel's RTK system permits L1/L2 receivers to choose integer lanes while forcing L1-only receivers to rely exclusively on the floating ambiguity solution.

Once the ambiguities are known, it is possible to solve for the vector from the reference station to the remote station. This baseline vector, when added to the position of the reference station, yields the position of the remote station.

In the NovAtel RTK system, the floating ambiguity and the integer position solutions (when both are available) are continuously compared for integrity purposes. The better one is chosen and output in the receiver's matched-position logs. The “best” ambiguities determined are used with the remote station's local observations and a reference station observation model to generate the remote station's low-latency observations.

NovAtel's RTK product line consists of RT-2 and RT-20 software. Performance characteristics of each are described in *Appendix E*.

B *Multipath Elimination Technology*

Multipath signal reception is one of the most plaguing problems that detracts from the accuracy potential of GPS pseudorange differential positioning systems. This section will provide a brief look at the problems of multipath reception and some solutions developed by NovAtel.

B.1 MULTIPATH

Multipath occurs when an RF signal arrives at the receiving antenna from more than one propagation route (multiple propagation paths).

Figure B-1 Illustration of GPS Signal Multipath

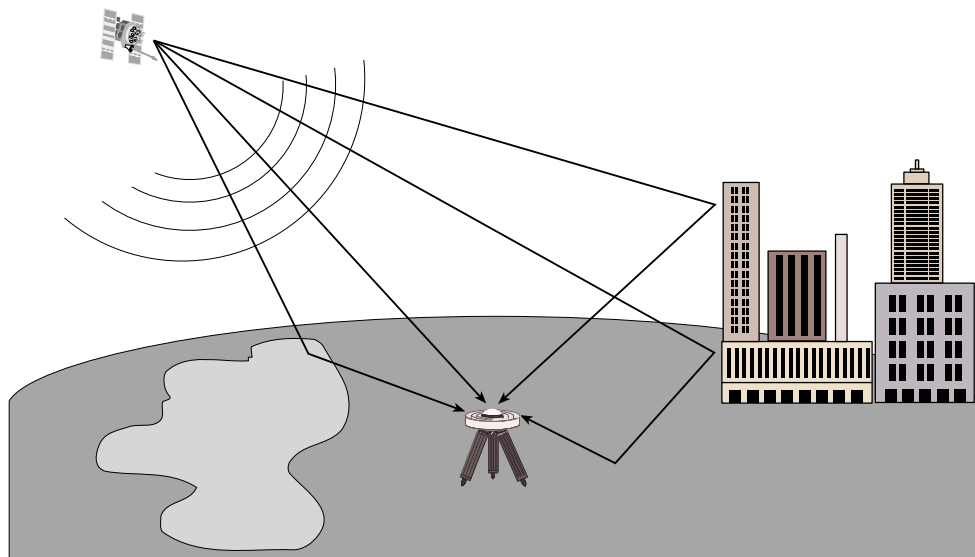

Why Does Multipath Occur?

When the GPS signal is emitted from the satellite antenna, the RF signal propagates away from the antenna in many directions. Because the RF signal is emitted in many directions simultaneously and is traveling different paths, these signals encounter various and differing natural and man-made objects along the various propagation routes. Whenever a change in medium is encountered, the signal is either absorbed, attenuated, refracted, or reflected.

Refraction and reflection cause the signals to change direction of propagation. This change in path directions often results in a convergence of the direct path signal with one or more of the reflected signals. When the receiving antenna is the point of convergence for these multipath signals, the consequences are generally not favorable.

Whenever the signal is refracted, some signal polarity shifting takes place; and when full reflection occurs, full polarity reversal results in the propagating wave. The consequences of signal polarity shifting and reversal at the receiving antenna vary from minor to significant. As well, refracted and reflected signals generally sustain some degree of signal amplitude attenuation.

It is generally understood that, in multipath conditions, both the direct and reflected signals are present at the antenna and the multipath signals are lower in amplitude than the direct signal. However, in some situations, the direct signal may be obstructed or greatly attenuated to a level well below that of the received multipath signal. Obstruction of direct path signals is very common in city environments where many tall buildings block the line of sight to the satellites. As buildings generally contain an abundance of metallic materials, GPS signal reflections are abundant (if not overwhelming) in these settings. Obstructions of direct path signals can occur in wilderness

settings as well. If the GPS receiver is in a valley with nearby hills, mountains and heavy vegetation, signal obstruction and attenuation are also very common.

Consequences of Multipath Reception

Because GPS is a radio ranging and positioning system, it is imperative that ground station signal reception from each satellite be of direct line of sight. This is critical to the accuracy of the ranging measurements. Obviously, anything other than direct line of sight reception will skew and bias the range measurements and thus the positioning triangulation (or more correctly, trilateration). Unfortunately, multipath is almost always present to some degree, due to real world conditions.

When a GPS multipath signal converges at the GPS antenna, there are two primary problems that occur:

1. a multiple signal with amplitude and phase shifting, and
2. a multiple signal with differing ranges.

When a direct signal and multipath signal are intercepted by the GPS antenna, the two signals will sum according to the phase and amplitude of each. This summation of signals causes the composite to vary greatly in amplitude, depending on the degree of phase shift between the direct signal versus the multipath signal. If the multipath signal lags the direct path signal by less than 90° the composite signal will increase in amplitude (relative to the direct signal, depending on the degree of phase shift between 0° and 90°). As well, if the multipath signal lags the direct path signal by greater than 90° but less than 270° the composite signal will decrease in amplitude. Depending on the relative amplitude of the multipath signal (or signals), the composite signal being processed by the receiver correlator may experience substantial amplitude variations, which can play havoc with the receiver's automatic gain control circuitry (AGC) as it struggles to maintain constant signal levels for the receiver correlator. A worst case scenario is when the multipath signal experiences a lag of 180° and is near the same strength as the direct path signal – this will cause the multipath signal to almost completely cancel out the direct path signal, resulting in loss of satellite phase lock or even code lock.

Because a multipath signal travels a greater distance to arrive at the GPS antenna, the two C/A code correlations are, by varying degrees, displaced in time, which in turn causes distortion in the correlation peak and thus ambiguity errors in the pseudorange (and carrier-phase, if applicable) measurements.

As mentioned in previous paragraphs, it is possible that the received multipath signal has greater amplitude than the direct path signal. In such a situation the multipath signal becomes the dominant signal and receiver pseudorange errors become significant due to dominant multipath biases and may exceed 150 meters. For single point pseudorange positioning, these occasional levels of error may be tolerable, as the accuracy expectations are at the 40 meter CEP level (using standard correlator). However, for pseudorange single differencing DGPS users, the accuracy expectations are at the one to five mere CEP level (with no multipath). Obviously, multipath biases now become a major consideration in trying to achieve the best possible pseudorange measurements and position accuracy.

If a differential reference station is subject to significant multipath conditions, this in turn will bias the range corrections transmitted to the differential remote receiver. And in turn, if the remote receiver also experiences a high level of multipath, the remote receiver position solutions will be significantly biased by multipath from both stations. Thus, when the best possible position solutions are required, multipath is certainly a phenomenon that requires serious consideration.

B.2 HARDWARE SOLUTIONS FOR MULTIPATH REDUCTION

A few options exist by which GPS users may reduce the level of multipath reception. Among these include: antenna site selection, special antenna design, and ground plane options.

Antenna Site Selection

Multipath reception is basically a condition caused by environmental circumstances. Some of these conditions you may have a choice about and some you may not.

Many GPS reception problems can be reduced, to some degree, by careful antenna site selection. Of primary importance is to place the antenna so that unobstructed line-of-sight reception is possible from horizon to horizon

and at all bearings and elevation angles from the antenna. This is, of course, the ideal situation, which may not be possible under actual operating conditions.

Try to place the antenna as far as possible from obvious reflective objects, especially reflective objects that are above the antenna's radiation pattern horizon. Another solution would be to install an RF fence pointing toward the reflector which is causing the multipath. When installed close to the antenna, it effectively attenuates the unwanted multipath signal. Close-in reflections will be stronger, and typically have a shorter propagation delay allowing for auto correlation of signals with a propagation delay of less than one C/A code chip (300 meters).

Figure B-2 Illustration of GPS Signal Multipath vs. Increased Antenna Height

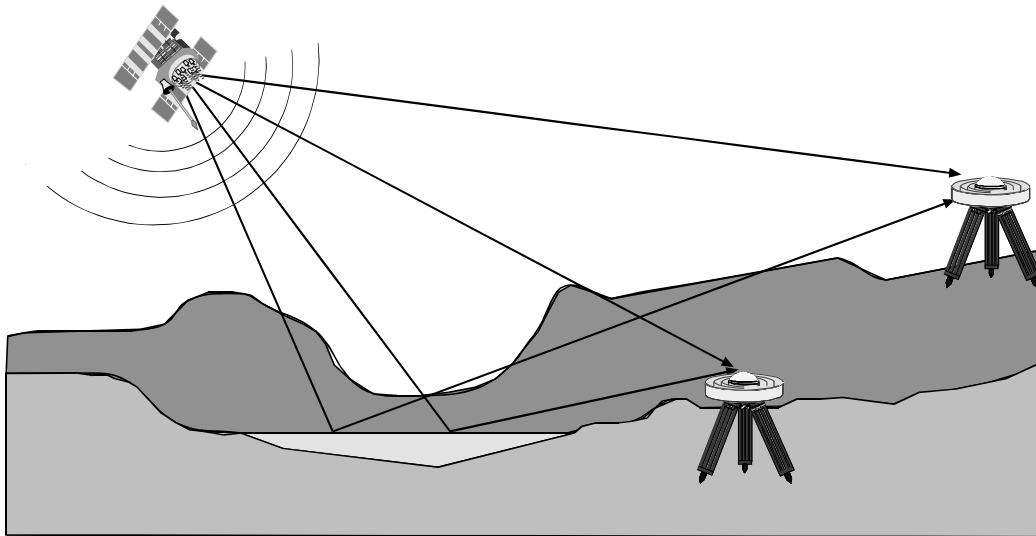

When the antenna is in an environment with obstructions and reflective surfaces in the vicinity, it is advantageous to mount the antenna as high as possible to reduce the obstructions, as well as reception from reflective surfaces, as much as possible.

Water bodies are extremely good reflectors of GPS signals. Because of the short wavelengths at GPS frequencies, even small ponds and water puddles can be a strong source of multipath reception, especially for low angle satellites. Thus, it can be concluded that water bodies such as lakes and oceans are among the most troublesome multipath environments for low angle signal reception. Obviously, water body reflections are a constant problem for ocean going vessels.

Antenna Designs

Low angle reflections, such as from water bodies, can be reduced by careful selection of antenna design. For example, flat plate microstrip patch antennas have relatively poor reception properties at low elevation angles near their radiation pattern horizon.

Quadrifilar helix antennas and other similar vertically high profile antennas tend to have high radiation gain patterns at the horizon. These antennas, in general, are more susceptible to the problems resulting from low angle multipath reception. So, for marine vessels, this type of antenna encourages multipath reception. However, the advantages of good low angle reception also means that satellites can be acquired more easily while rising in the horizon. As well, vessels subject to pitch and roll conditions will experience fewer occurrences of satellite loss of lock.

A good antenna design will also incorporate some form of left hand circular polarization (LHCP) rejection. Multipath signals change polarization during the refraction and reflection process. This means that generally, multipath signals may be LHCP oriented. This property can be used to advantage by GPS antenna designers. If a GPS antenna is well designed for RHCP polarization, then LHCP multipath signals will automatically be attenuated somewhat during the induction into the antenna. To further enhance performance, antennas can be designed to increase the rejection of LHCP signals. NovAtel's GPSAntenna model 501 is an example of an antenna optimized to further reject LHCP signals by more than 10 dB.

The Model 600 GPS Antenna is an active antenna designed to operate at the GPS L1 and L2 frequencies, 1575.42 and 1227.60 MHz. It incorporates NovAtel's innovative, patent pending Pinwheel Technology - a unique aperture coupled slot array configuration. The microstrip receiving elements is coupled to a low-noise amplifier (LNA). The unit is optimized to receive right-hand-circularly-polarized signals, and its radiation pattern is shaped to reduce signals arriving at low elevation angles; these features decrease the errors associated with electromagnetic interference and multipath. Also, the model 600 gain pattern roll-off compares well to a patch antenna roll-off mounted on a large choke ring ground plane. This antenna provides comparable performance to the choke ring ground plane antenna while being much lighter and smaller.

Figure B-3 Illustration of Quadrifilar vs. Microstrip Patch Antennae

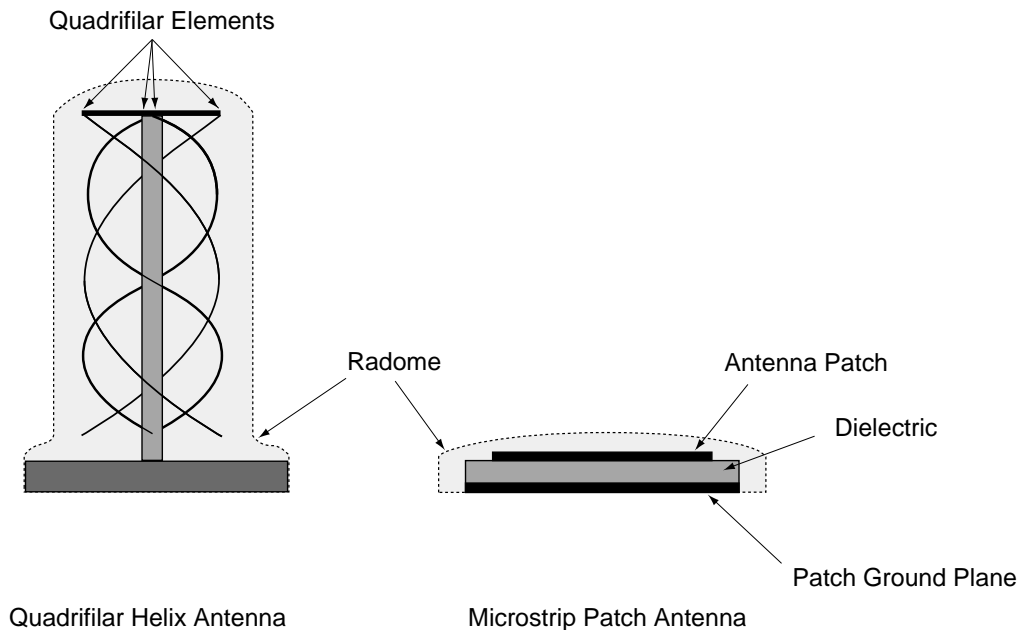

Antenna Ground Planes

Nearby objects can influence the radiation pattern of an antenna. Thus, one of the roles of the antenna ground plane is to create a stabilizing artificial environment on which the antenna rests and which becomes a part of the antenna structure and its resultant radiation pattern.

A small ground plane (relative to one wavelength at the operating frequency) may have minimal stabilizing effect, whereas a large ground plane (multiple wavelengths in size) will have a highly stabilizing effect.

Large ground planes also exhibit a shielding effect against RF signal reflections originating below the antenna's radiation pattern horizon. This can be a very effective low angle shield when the antenna is elevated on a hill or other structure above other reflecting surfaces such as vehicles, railway tracks, soil with high moisture content, water bodies, etc.

One of the drawbacks of a "flat plate" ground plane is that it gives a "hard boundary condition", i.e. allowing electromagnetic waves to propagate along the ground plane and diffract strongly from its edge. The "soft boundary" condition, on the other hand, will prevent the wave from propagating along the surface of the ground plane and thereby reducing the edge diffraction effects. As a result the antenna will exhibit a completely different radiation pattern. The "soft boundary" condition is typically achieved by a quarter wavelength deep, transversely corrugated ground plane surface (denoted as "choke ring ground plane"). When the depth of the corrugation (choke rings) is equal to a quarter wavelength, the surface wave vanishes, and the surface impedance becomes infinite and hence provides the "soft boundary" condition for the electromagnetic field. This results in modifications to the antenna radiation pattern that is characterized by low back lobe levels, no ripples in the main lobe, sharper amplitude, roll-off near the horizon and better phase center stability (there are smaller variations in 2 axes). This is

what makes NovAtel's GPS antennas so successful when used with the NovAtel GPSAntenna choke ring ground plane.

NovAtel's Internal Receiver Solutions for Multipath Reduction

The multipath antenna hardware solutions described in the previous paragraphs are capable of achieving varying degrees of multipath reception reduction. These options, however, require specific conscious efforts on the part of the GPS user. In many situations, especially kinematic, few (if any) of the above solutions may be effective or even possible to incorporate. By far, the best solutions are those which require little or no special efforts in the field on the part of the GPS user. This is what makes NovAtel's internal receiver solutions so desirable and practical.

NovAtel has placed long term concerted effort into the development of internal receiver solutions and techniques that achieve multipath reduction, all of which are transparent to the GPSCard user. These achievements have led to Narrow Correlator tracking technology.

It utilizes innovative patented correlator delay lock loop (DLL) techniques. As it is beyond the scope of this manual to describe in detail how the correlator techniques achieve the various levels of performance, the following paragraphs will provide highlights of the advantages of this technology.

NARROW CORRELATOR TRACKING TECHNOLOGY

NovAtel's MiLLennium GPSCard receivers achieve a higher level of pseudorange positioning "performance" vs. standard (wide) correlator, by virtue of its celebrated Narrow Correlator tracking technology. By utilizing Narrow Correlator tracking techniques, the MiLLennium GPSCard is capable of pseudorange measurement improvements better than 2:1 when compared to standard correlation techniques. As well, the Narrow Correlator tracking technology inherently reduces multipath reception (approaching a factor of eight compared to standard correlator) by virtue of its narrower auto correlation function.

Figure B-4, Page 80 illustrates relative multipath-induced tracking errors encountered by standard correlators vs. NovAtel's Narrow Correlator tracking technology. As can be seen, standard correlators are susceptible to substantial multipath biases for C/A code chip delays of up to 1.5 chip, with the most significant C/A code multipath bias errors occurring at about 0.25 and 0.75 chip (approaching 80 m error). On the other hand, the Narrow Correlator tracking technology multipath susceptibility peaks at about 0.2 chip (about 10 m error) and remains relatively constant out to 0.95 chip, where it rapidly declines to negligible errors after 1.1 chip.

While positioning in single point mode, the multipath and ranging improvement benefits of a Narrow Correlator tracking technology receiver vs. standard correlator are overridden by a multitude of GPS system biases and errors (with or without an antenna choke ring ground plane). In either case, positioning accuracy will be in the order of 40 meters CEP (SA on, no multipath). However, the benefits of the Narrow Correlator tracking technology become most significant during pseudorange DGPS operation, where the GPS systematic biases are largely cancelled.

Receivers operating DGPS with standard correlator technology typically achieve positioning accuracies in the two to five meter CEP range (low multipath environment and using choke ring ground plane), while NovAtel's Narrow Correlator tracking technology receivers are able to achieve positioning accuracies in the order of 0.75 meter CEP (low multipath environment and using choke ring ground plane). The Narrow Correlator tracking technology achieves this higher accuracy through a combination of lower noise ranging measurements combined with its improved multipath resistance when compared to the standard correlator.

Figure B-4 Comparison of Multipath Envelopes

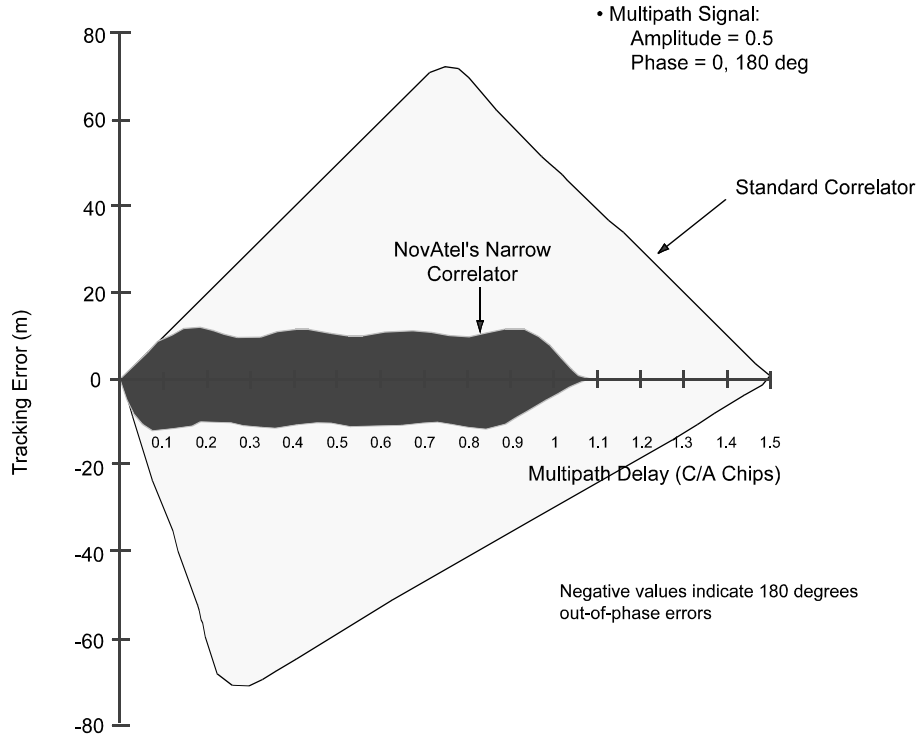

SUMMARY

Any localized propagation delays or multipath signal reception cause biases to the GPS ranging measurements that cannot be differenced by traditional DGPS single or double differencing techniques. SA contributes the most errors when it is active. Generally speaking, single point positioning systems are not too concerned with multipath reception unless SA is inactive so that multipath and ionospheric errors are the largest. However, multipath is recognized as the greatest source of errors encountered by a system operating in differential mode. It has been discussed that careful site selection and the GPS Antenna model 600, or good antenna design combined with a choke ring ground plane are very effective in reducing multipath reception.

Internal receiver solutions for multipath elimination are achieved through various types of correlation techniques, where the "standard correlator" is the reference by which all other techniques can be compared.

The Narrow Correlator tracking technology has a two fold advantage over standard correlators: improved ranging measurements due to a sharper, less noisy correlation peak, and reduced susceptibility to multipath due to rejection of C/A code delays of greater than 1.0 chip. When used with a choke ring ground plane, the Narrow Correlator tracking technology provides substantial performance gains over standard correlator receivers operating in differential mode.

C**COMMANDS SUMMARY****ACCEPT**

The ACCEPT command controls the processing of input data and is primarily used to set the GPSCard's COM port command interpreter for acceptance of various data formats. Each port can be controlled to allow ASCII command processing (default), binary differential data processing, or the command interpreter can be turned off.

The command interpreter automatically distinguishes between ASCII commands and certain NovAtel-format ASCII and binary logs without receiving an ACCEPT command.

MiLLennium GPSCards will by default interpret \$RTCM59A corrections, and will interpret RTCM59 if ACCEPT RTCM has been entered.

On certain GPSCards the ACCEPT *port* COMMANDS mode will by default accept, interpret, and process these data messages: \$PVAA, PVAB, \$REPA, REPB, \$RTCM1A, \$RTCAA, \$RTCM3A, \$RTCM9A, \$RTCM16A, \$TM1A and TM1B, without any other initialization required.

The command interpreter can process some NovAtel-format binary logs (which have a proprietary header) or ASCII logs without receiving an ACCEPT command. **Therefore, the ACCEPT command is needed only for the RTCA, RTCM and CMR logs.** When using ACCEPT RTCM, the interpretation of the RTCM data will follow the rules defined by the RTCMRULE command (see Chapter 4, Message Formats, Page 46). In the default processing mode (ACCEPT *port* COMMANDS), input ASCII data received by the specified port will be interpreted and processed as a valid GPSCard command. If the input data cannot be interpreted as a valid GPSCard command, an error message will be echoed from that port (if the command MESSAGES is "ON"). When valid data is accepted and interpreted by the port, it will be processed and acknowledged by echoing the port prompt (with the exception of VERSION and HELP commands, which reply with data before the prompt).

In the binary differential data processing modes, (ACCEPT *port* RTCA/RTCM/CMR), only the applicable data types specified will be interpreted and processed by the specified COM port; no other data will be interpreted. It is important to note that only one out of two COM ports can be specified to accept binary differential correction data. Both ports cannot be set to accept differential data at the same time.

When ACCEPT *port* NONE is set, the specified port will be disabled from interpreting any input data. Therefore, no commands or differential corrections will be decoded by the specified port. However, data can still be logged out from the port, and data can be input to the port for formatting into Pass-Through logs (see Chapter 5, Page 46). If the GPSCard operator wants to time-tag non-GPS messages as a Pass-Through log, it is recommended that the port accepting the Pass-Through data be set to "NONE". This will prevent the accepting GPSCard COM port from echoing error messages in response to receipt of unrecognized data. If you do not wish to disable the command interpreter, and do want to disable message error reporting, see the MESSAGES command, Appendix C, Page 110.

The GPSCard user can monitor the differential data link as well as the data decoding process by utilizing the CDSA/B logs. See the CDSA/B log, Appendix D, Page 146 for more information on data link monitoring.

Syntax:

```
ACCEPT  
```

Syntax	Range Value	Description	Default
ACCEPT	-	Command	
port	COM1 or COM2	Specifies the COM port to be controlled	
option	NONE	Turn off Command Interpreter	commands
(GPSCard model dependent)	COMMANDS RTCA RTCM CMR	Command Interpreter attempts to interpret all incoming data. Will also interpret certain ASCII and NovAtel format binary logs. Interprets RTCAB or raw binary RTCA data only (Types 1,7) Interprets raw binary RTCM data only (Types 1,2,3,9,16,18,19 and 59N) Receives CMR messages (Version 1.0, 2.0 or 3.0)	

Example:

```
accept com1 rtcn
```

ANTENNAPOWER

On MiLlennium GPSCards this command enables or disables the supply of electrical power from the internal power source of the card to the low-noise amplifier (LNA) of an active antenna. Jumper P301 allows the user to power the LNA either by an internal power source (plug connects pins 1&2) or an optional external power source (plug connects pins 2&3); or, the user can cut off all power to the antenna (plug removed). For more information on these jumper settings, please refer to *Chapter 3 of the MiLlennium Guide to Installation and Operation*. The ANTENNAPOWER command, which is only relevant when Jumper P301 is set to connect pins 1&2, determines whether or not internal power is applied to pin 1 of Jumper P301. *Table C-1* summarizes the combinations:

Table C-1 Antenna LNA Power Configuration

	P301: plug connects pins 1&2	P301: plug connects pins 2&3	P301: no plug
ANTENNAPOWER = ON	internal power connected to LNA	no external effect	no external effect
ANTENNAPOWER = OFF	internal power cut off from LNA	no external effect	no external effect

The setting of this command will affect the way the MiLlennium’s self-test diagnostics (see *Table D-5, Page 198*) report the antenna’s status.

NOTE: If the hardware overcurrent protection circuit turns the power off, you can use the ANTENNAPOWER ON command to turn the power back on.

Syntax:

ANTENNAPOWER flag

Command	Range Value	Description	Default
ANTENNAPOWER		Command	on
flag	(none)	Displays status of the internal antenna-power supply.	
	ON	If plug on P301 joins pins 1&2, connects internal power to the LNA. Antenna status will be reported as “GOOD” unless a fault is detected, in which case the status will change to “BAD” and the internal power cut off from pin 1.	
	OFF	If plug on P301 joins pins 1&2, cuts off internal power from the LNA. Antenna status will always be reported as “GOOD”.	

Example:

```
antennapower off
```

ASSIGN

This command may be used to aid in the initial acquisition of a satellite by allowing you to override the automatic satellite/channel assignment and reacquisition processes with manual instructions. The command specifies that the indicated tracking channel search for a specified satellite at a specified Doppler frequency within a specified Doppler window. The instruction will remain in effect for the specified SV channel and PRN, even if the assigned satellite subsequently sets. If the satellite Doppler offset of the assigned SV channel exceeds that specified by the Search-Window parameter of the ASSIGN command, the satellite may never be acquired or re-acquired. To cancel the effects of ASSIGN, you must issue the UNASSIGN or UNASSIGNALL command, or reboot the GPSCard.

When using this command, NovAtel recommends that you monitor the *channel tracking status* (ETSA/B) of the assigned SV channel and then use the UNASSIGN or UNASSIGNALL commands to cancel the command once the channel has reached channel state 4, the Phase Lock Loop (PLL) state. See *Appendix D, Page 157*, the ETSA/B ASCII log structure and *Table D-7, Page 203* for an explanation of the various channel tracking states.

NOTE: Assigning a PRN to a SV channel does not remove the PRN from the search space of the automatic searcher; only the SV channel is removed. By default, the automatic searcher only searches for the GPS satellites (PRNs 1-32).

The *[doppler]* and *[search-window]* parameters are optional. If *[doppler]* is not specified, its range value will default to 0, and if *[search-window]* is not specified, its range value will default to 10,000.

There are two syntactical forms of this command, as shown below.

Syntax #1:

ASSIGN

Syntax	Range Value	Description	Default	Example
ASSIGN	-	Command	unassignall	assign
channel	0 - 11	Desired SV channel number from 0 to 11 inclusive (channel 0 represents first channel, channel 11 represents twelfth channel)		0
prn	1 - 32	A satellite PRN integer number from 1 to 32 inclusive		29
doppler	-100,000 to 100,000 Hz	Current Doppler offset of the satellite Note: Satellite motion, receiver antenna motion and receiver clock frequency error must be included in the calculation for Doppler frequency.		0
search-window	0 - 10,000	Error or uncertainty in the Doppler estimate above in Hz Note: Any positive value from 0 to 10000 will be accepted. Example: 500 implies ± 500 Hz.		2000

Example 1: `assign 0,29,0,2000`

In example 1, the first SV channel will try to acquire satellite PRN 29 in a range from -2000 Hz to 2000 Hz until the satellite signal has been detected.

Example 2: `assign 11,28,-250,0`

The twelfth SV channel will try to acquire satellite PRN 28 at -250 Hz only.

Syntax #2:

ASSIGN

Syntax	Range Value	Description	Default	Example
ASSIGN	-	Command	unassignall	assign
channel	0 - highest channel number	Desired SV channel number from maximum SV channel number inclusive		0
keyword	IDLE	Idles SV channel (not case sensitive)		idle

Example 3: `assign 11,idle`

In Example 3, SV channel 11 will be idled and will not attempt to search for satellites.

CLOCKADJUST

All oscillators have some inherent drift. On the MiLLennium GPSCard, the clock and the PPS strobe have a 50 ns jitter due to the receiver's attempts to keep the clock as close as possible to GPS time. This option is disabled by entering CLOCKADJUST DISABLE. The jitter will vanish, but the unsteered and free-running clock will drift relative to GPS time. CLOCKADJUST must also be disabled if the user wishes to measure the drift rate of the oscillator using the CLKA/B data logs.

NOTE 1: This feature is to be used by advanced users only.

NOTE 2: Please note that, when disabled, the range measurement bias errors will continue to accumulate with clock drift.

NOTE 3: Pseudorange, carrier phase and Doppler measurements may jump if CLOCKADJUST DISABLE is issued while the receiver is tracking.

NOTE 4: Do not disable CLOCKADJUST after 30 seconds from turning the power on, as unpredictable clock drifts may result. When disabled, the range measurement bias errors will continue to accumulate with clock drift.

NOTE 5: If you have difficulty issuing the CLOCKADJUST DISABLE command within the 30 second time limit, you can enter it using a terminal emulator program and then issuing the SAVECONFIG command to save this setting to the NVM of the receiver, where it will be automatically loaded each time the GPSCard is powered on. Do not issue the SAVECONFIG command when using GPSolution.

Syntax:

CLOCKADJUST switch

Syntax	Range Value	Description	Default
CLOCKADJUST	-	Command	
switch	enable or disable	Allows or disallows adjustment to the internal clock	enable

Example:

```
clockadjust disable
```

COMn

This command permits you to configure the GPSCard COM port's asynchronous drivers.

Syntax:

COMn

Syntax	Value	Description	Default	Example
COMn	n = 1 or 2	Specify COM port		com2
bps	300, 600, 1200, 2400, 4800, 9600, 19200, 38400, 57600 or 115,200	Specify bit rate	9600	19200
parity	N (none), O (odd) or E (even)	Specify parity	N	E
databits	7 or 8	Specify number of data bits	8	7
stopbits	1 or 2	Specify number of stop bits	1	1
handshake	N (none), XON (Xon/Xoff) or CTS (CTS/RTS)	Specify handshaking	N	N
echo	ON or OFF	Specify echo	OFF	ON
FIFO	ON or OFF	Transmit the First In First Out queue of the GPSCard's serial port UART.	ON	OFF

Examples:

```
com2 19200,e,7,1,n,on,off
com1 1200,e,8,1,n,on,off
```

NOTE: Your GPSCard comes configured this way. If you have different parameters you should reconfigure the communication protocol as per requirements.

COMn_DTR

This command enables versatile control of the DTR handshake line for use with *output data logging* in conjunction with external devices such as a radio transmitter. The default state for the COM1 or COM2 DTR line is always high.

Syntax:

COMn_DTR

Syntax	Option	Description	Default	Example
COMn_DTR	n = 1 or 2	Selects COM1 or COM2 port		com1_dtr
control	high	control is always high	high	toggle
	low	control is always low		
	toggle	control toggles between high and low (active, lead, and tail fields are TOGGLE options only)		
active	high	data available during high	n/a	high
	low	data available during low		
lead	variable	lead time before data transmission (milliseconds)	n/a	300
tail	variable	tail time after data transmission (milliseconds)	n/a	150

Examples:

```
com1_dtr toggle,high,300,150
com2_dtr toggle,low,200,110
```

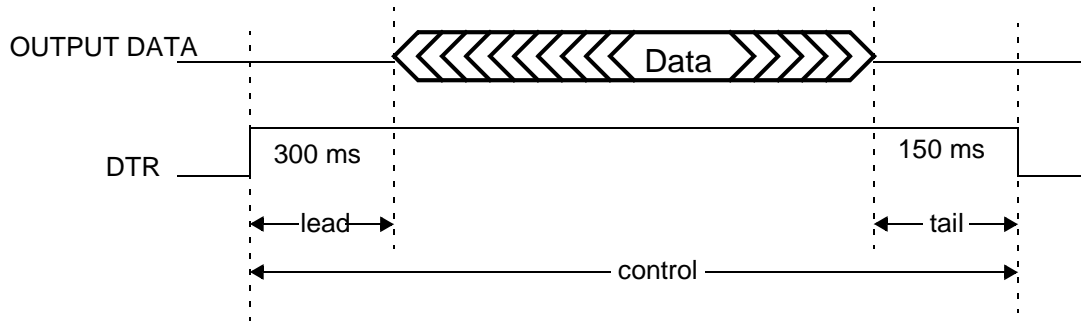

COMn_RTS

This command enables versatile control of the RTS handshake line for use with *output data logging* in conjunction with external devices such as a radio transmitter. The default state for the COM1 or COM2 RTS line is always high. COMn_RTS will not influence the COMn command handshake control of incoming commands.

Syntax:

```
COMn_RTS [control] [active] [lead] [tail]
```

Syntax	Option	Description	Default	Example
COMn_RTS	n = 1 or 2	Selects COM1 or COM2 port		com1_rts
control	high	control is always high	high	toggle
	low	control is always low		
	toggle	control toggles between high and low (active, lead, and tail fields are TOGGLE options only)		
active	high	data available during high	n/a	high
	low	data available during low		
lead	variable	lead time before data transmission (milliseconds)	n/a	200
tail	variable	tail time after data transmission (milliseconds)	n/a	100

Example:

```
com1_rts toggle,high,200,100
com2_rts toggle,low,250,125
```

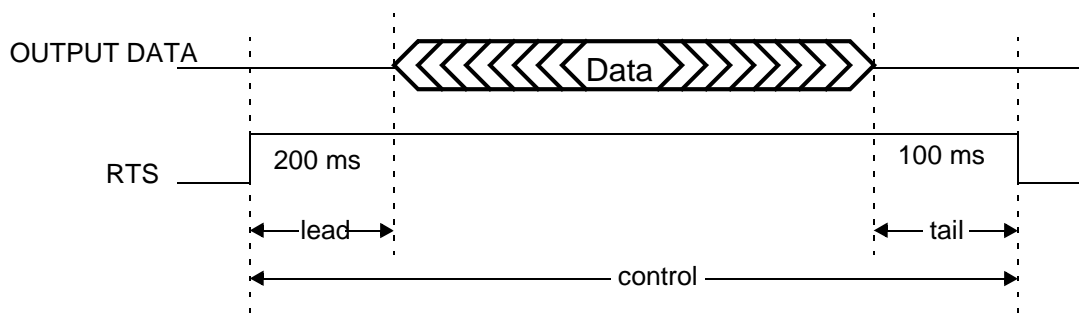

CONFIG

This command switches the channel configuration of the GPSCard between pre-defined configurations. When invoked, this command loads a new satellite channel-configuration and forces the GPSCard to reset. The types of configurations possible are listed by entering this command:

```
HELP CONFIG
```

In some applications, only the standard (default) configuration will be listed in response. The standard configuration of a MiLLennium GPSCard consists of 12 L1/L2 channel pairs.

Syntax:

```
CONFIG 
```

Command	Option	Description	Default
CONFIG		Command	
cfgtype	(none)	Displays present channel configuration	MiLLen-STD: STANDARD
	configuration name	Loads new configuration, resets GPSCard: STANDARD 12 GPS WAASCORR ^a 10 GPS + 1 WAAS	MiLLen-STDW: WAASCORR

a. This cfgtype is only available on WAAS/EGNOS enabled models.

CRESET

Configuration Reset. Resets user configuration to the factory default. After a reset, non volatile memory (NVM) is read for user configuration. This command does not reset the hardware. See the *Factory Default Settings*.

Syntax:

```
CRESET
```

See also the FRESET and RESET commands. These three commands differ in the following way:

- RESET - Resets the hardware. Similar to powering the card off and on again.
- CRESET - Resets user configuration to the factory default. This command does not reset the hardware.
- FRESET - Completely resets the receiver to a factory state. Anything that was saved to NVM is erased (including Saved Config, Saved Almanac and Channel Config). The hardware is also reset.

CSMOOTH

This command sets the amount of carrier smoothing to be performed on the pseudorange measurements carrier. An input value of 100 corresponds to approximately 100 seconds of smoothing. Upon issuing the command, the locktime for all tracking satellites is reset to zero. From this point each pseudorange smoothing filter is restarted. The user must wait for at least the length of smoothing time for the new smoothing constant to take full effect. 20 seconds is the default smoothing constant used in the GPSCard. The optimum setting for this command is dependent on the user's application and thus cannot be specified.

Syntax:

```
CSMOOTH      [L1 time]  [L2 time]
```

Syntax	Range Value	Description	Default
CSMOOTH	-	Command	
L1 time	2 to 1000	L1 carrier smoothing time constant. Value in seconds	20
[L2 time]	2 to 1000	L2 carrier smoothing time constant. Value in seconds	

Example:

```
csmooth 500
```

NOTE: The CSMOOTH command should only be used by advanced users of GPS.

It may not be suitable for every GPS application. When using CSMOOTH in a differential mode, the same setting should be used at both the reference and remote station. The shorter the carrier smoothing the more noise there will be. If you are at all unsure please call NovAtel Customer Service Department, see the *Software Support* section at the start of this manual.

DATUM

This command permits you to select the geodetic datum for operation of the receiver. If not set, the value is defaulted to WGS84. See *Table G-2* in *Appendix G* for a complete listing of all available predefined datums. See the USERDATUM command for user definable datums. The datum you select will cause all position solutions to be based on that datum (except PXYA/B which is always based on WGS84).

Syntax:

DATUM

Syntax	Datum Option	Description	Default
DATUM	any one of 62 predefined datums	For a complete list of all 62 predefined datums, see <i>Table G-2</i> in <i>Appendix G</i> .	WGS84
	USER	User defined datum with parameters specified by the USERDATUM command (Default WGS84)	

Example:

datum tokyo Sets the system datum to Tokyo

NOTE: The actual datum name must be entered in this command as listed in the NAME column of *Table G-2*. Also note that references to datum in the following logs use the GPSCard Datum ID #: MKPA/B, PRTKA/B, POSA/B and RTKA/B.

DGPSTIMEOUT

This command has a two-fold function:

- (1) to set the maximum age of differential data that will be accepted when operating as a remote station. Differential data received that is older than the specified time will be ignored. When entering DGPS delay, you can ignore the ephemeris delay field.
- (2) to set the ephemeris delay when operating as a reference station. The ephemeris delay sets a time value by which the reference station will continue to use the old ephemeris data. A delay of 120 to 300 seconds will typically ensure that the remote stations have collected updated ephemeris. After the delay period is passed, the reference station will begin using new ephemeris data. To enter an ephemeris delay value, you must first enter a numeric placeholder in the DGPS delay field (e.g., 2). When operating as a reference station, DGPS delay will be ignored.

Syntax:

```
DGPSTIMEOUT dgps delay ephem delay
```

Command	Option	Description	Default
DGPSTIMEOUT		Command	
dgps delay	min. 2 max. 1000	Maximum age in seconds	60
ephem delay	min. 0 max. 600	Minimum time delay in seconds	120

Example 1 (remote):

```
dgpstimeout 15
```

Example 2 (reference):

```
dgpstimeout 2,300
```

NOTE 1: The RTCA Standard for SCAT-I stipulates that the maximum age of differential correction messages cannot be greater than 22 seconds. Therefore, for RTCA logs, the recommended DGPS delay setting is 22.

NOTE 2: The RTCA Standard also stipulates that a reference station shall wait five minutes after receiving a new ephemeris before transmitting differential corrections. This time interval ensures that the remote stations will have received the new ephemeris, and will compute differential positioning based upon the same ephemeris. Therefore, for RTCA logs, the recommended ephemeris delay is 300 seconds.

DIFF_PROTOCOL

This log enables differential protocol control.

NOTE: *The DIFF_PROTOCOL command should only be used by advanced users of GPS.*

Features:

1. A user definable key such that many different types of encoding may be used in the same area without cross talk between the various “channels”.
2. Encodes all correction data following any header specific to the message type.
3. Non-volatile. When the base station card is restarted, the previously selected encoding key is used for all subsequent differential data.
4. The encoding key is not visible by any method of interrogation.

Syntax:

```

DIFF_PROTOCOL [Type] [Key]
or
DIFF_PROTOCOL [DISABLE]
or
DIFF_PROTOCOL
  
```

Syntax	Range Value	Description	Default
DIFF_PROTOCOL	-	Command	
type	1, DISABLE	Encoding Algorithm	
key	0 - FFFFFFFF	32 Bit Encoding key	

NOTE: If no parameters are given to the command, the encoding type value will be reported. The key value is not visible at anytime.

The only supported type of encoding is “Type 1”, which will only encode RTCM data with the algorithm described below.

The non-volatility of the command is acquired via the SAVECONFIG command. This command stores the current settings in non-volatile memory.

All header information necessary for parsing the incoming data stream remains unencoded.

RTCM/A/B LOGS

The NovAtel log format wrapping of the RTCMA and RTCMB logs remains unencoded and only the raw RTCM data is encoded beginning after the second word of the message. This will leave the entire header unencoded:

WORD 1	Preamble	Message Type (Frame ID)	Station ID	Parity
WORD 2	Modified Z-Count	Sequence No.	Length of Frame	Parity
REMAINING...	Encoded data...			

DYNAMICS

This command informs the receiver of user dynamics. It is used to optimally tune receiver parameters.

Syntax:

```
DYNAMICS user_dynamics
```

Command		Description	Default
DYNAMICS	Command		dynamics
user_dynamics	air	receiver is an aircraft	air
	land	receiver is in a land vehicle with velocity less than 110 km/h (30m/s)	
	foot	receiver is being carried by a person with velocity less than 11 km/h (3m/s)	

Example:

```
dynamics foot
```

ECUTOFF

This command sets the elevation cut-off angle for usable satellites. The GPSCard will not start tracking a satellite until it rises above the cutoff angle. If there are six or less satellites being tracked and one drops below this angle, it will continue to be tracked until the signal is lost. However, if there are more than six satellites being tracked, any that are below the cutoff angle will be dropped completely.

In either case, satellites below the ECUTOFF angle will be eliminated from the internal position and clock offset solution computations only.

This command permits a negative cut-off angle; it could be used in these situations:

- the antenna is at a high altitude, and thus can look below the local horizon
- satellites are visible below the horizon due to atmospheric refraction

Syntax:

ECUTOFF

Syntax	Range Value	Description	Default
ECUTOFF	-	Command	
angle	-90° to +90°	Value in degrees (relative to the horizon).	0

Example:

```
ecutoff 5
```

NOTE 1: When ECUTOFF is set to zero (0), the receiver will track all SVs in view including some within a few degrees below the horizon.

NOTE 2: Care must be taken when using ECUTOFF because the information you are tracking from lower elevation satellite signals are going through more atmosphere, for example ionospheric and tropospheric, and therefore being degraded.

EXTERNALCLOCK

Overview

The EXTERNALCLOCK and EXTERNALCLOCK FREQUENCY commands allows the MiLLennium GPSCard to operate with an optional external oscillator. The user is able to optimally adjust the clock model parameters of the GPSCard for various types of external clocks. The three-state clock model on GPSCards having access to this command is different from that used on the other GPSCards.

NOTE: *The EXTERNALCLOCK command will affect the interpretation of the CLKA/B log.*

There are three steps involved in using an external oscillator:

1. Follow the procedure outlined in your GPSCard's installation/operation manual for connecting an external oscillator to your GPSCard.
2. For the chosen oscillator type, use the EXTERNALCLOCK FREQUENCY command to select the operating frequency – either 5 MHz or 10 MHz.
3. Using the EXTERNALCLOCK command, select a standard oscillator or define a new one; the effect is to define h_0 , h_{-1} , and h_{-2} in the expression for $S_y(f)$ given below.

Steps #2 and #3 define certain parameters used in the clock model for the external oscillator

Theory

An unsteered oscillator can be approximated by a three-state clock model, with two states representing the range bias and range bias rate, and a third state assumed to be a Gauss-Markov (GM) process representing the range bias error generated from satellite clock dither. The third state is included because the Kalman filter assumes an (unmodeled) white input error. The significant correlated errors produced by SA clock dither are obviously not white and the Markov process is an attempt to handle this kind of short-term variation.

The internal units of the new clock model's three states (offset, drift and GM state) are meters, meters per second, and meters. When scaled to time units for the output log, these become seconds, seconds per second, and seconds, respectively. Note that the old units of the third clock state (drift rate) were meters per second per second.

The user has control over 3 process noise elements of the linear portion of the clock model. These are the h_0 , h_{-1} , and h_{-2} elements of the power law spectral density model used to describe the frequency noise characteristics of oscillators:

$$S_y(f) = \frac{h_{-2}}{f^2} + \frac{h_{-1}}{f} + h_0 + h_1 f + h_2 f^2$$

where f is the sampling frequency and $S_y(f)$ is the clock's power spectrum. Typically only h_0 , h_{-1} , and h_{-2} affect the clock's Allan variance and the clock model's process noise elements.

Usage

Before using an optional external oscillator, several clock model parameters must be set. There are default settings for a voltage-controlled temperature-compensated crystal oscillator (VCTCXO), ovenized crystal oscillator (OCXO), Rubidium and Cesium standard; or, the user may choose to supply customized settings.

Syntax:

EXTERNALCLOCK

Command	Option	Description	Default
EXTERNALCLOCK	disable	Revert to the on-board oscillator MiLLennium = VCTCXO	see <i>Table C-2</i>
	ocxo	Set defaults for ovenized crystal oscillator	
	rubidium	Set defaults for rubidium oscillator	
	cesium	Set defaults for cesium oscillator	
	user h_0 h_1 h_2	Define custom values for process noise elements	

Example:

```
externalclock user 1.0e-20 1.0e-24 1.0e-28
```

Table C-2 Default Values of Process Noise Elements

Timing Standard	h_0	h_1	h_2
VCTCXO	1.0 e-21	1.0 e-20	2.0 e-20
OCXO	2.51 e-26	2.51 e-23	2.51 e-22
rubidium	1.0 e-23	1.0 e-22	1.3 e-26
cesium	2.0 e-20	7.0 e-23	4.0 e-29
user (min / max)	$1.0 \text{ e-}31 \leq h_0 \leq 1.0 \text{ e-}18$	$1.0 \text{ e-}31 \leq h_1 \leq 1.0 \text{ e-}18$	$1.0 \text{ e-}31 \leq h_2 \leq 1.0 \text{ e-}18$

EXTERNALCLOCK FREQUENCY

Please see the *Overview* and *Theory* sub-sections under the EXTERNALCLOCK command to understand the steps involved in using an optional external oscillator with a MiLLennium GPSCard.

For the chosen oscillator, one must select the clock rate using the EXTERNALCLOCK FREQUENCY command. The MiLLennium GPSCard only accepts a 5 MHz or 10 MHz external input. An internal frequency synthesizer converts this input to 20 MHz, the actual clock rate required by the MiLLennium GPSCard (and that which is generated by its on-board VCTCXO).

Syntax:

```
EXTERNALCLOCK FREQUENCY 
```

Command	Range	Description	Default
EXTERNALCLOCK FREQUENCY	-		
clock rate	5 or 10	Set clock rate to 5 MHz or 10 MHz (Will not allow values other than 5 or 10)	10

Example:

```
externalclock frequency 5
```

FIX HEIGHT

This command configures the GPSCard in 2D mode with its height constrained to a given value. The command would be used mainly in marine applications where height in relation to mean sea level may be considered to be approximately constant. The height entered using this command is always referenced to the geoid (mean sea level, see the PRTKA/B log in *Chapter 4* and *Appendix D*) and uses units of meters. The FIX HEIGHT command will override any previous FIX HEIGHT or FIX POSITION command and **disables** the output of differential corrections. The receiver is capable of receiving and applying differential corrections from a reference station while FIX HEIGHT is in effect. Use the UNFIX command to disable the current FIX command. No special solution status is reported in the POSA/B or PRTKA/B logs for a 2 dimensional solution. This mode is detected by the standard deviation of the height being 0.001m.

Syntax:

```
FIX HEIGHT  |
```

Syntax	Range Value	Description	Default
FIX HEIGHT	-	Command	unfix
value	<i>height</i>	-1,000.0 to 20,000,000.0 Height in metres above mean sea level	
	<i>auto</i>	The receiver will automatically fix the height at the last calculated value if the number of satellites available is insufficient for a 3-D solution, to provide a 2-D solution. Height calculation will resume when the number of satellites available returns to 4 or more. The use of the UNFIX command, or a different FIX command will disable the automatic fix height mode. It is disabled by default.	

Example:

```
fix height 4.567
```

or

```
fix height auto
```

REMEMBER: Any error in the height estimate will cause an error in the position computed of the same order of magnitude or higher. For example, if the user fixed height to zero and the antenna was installed on a 20 meter mast, the position can be expected to be in error by 10 to 60 meters, depending on the geometry of the satellites. This command should only be used when absolutely necessary, i.e., when only three satellites are visible.

NOTE: This command only affects pseudorange corrections and solutions, and so has no meaning within the context of RT-2 and RT-20.



FIX POSITION

Invoking this command will result in the GPSCard position being held fixed. A computation will be done to solve local clock offset, pseudorange, and pseudorange differential corrections. This mode of operation can be used for time transfer applications where the position is fixed and accurate GPS time output is required (see the CLKA/B and TM1A/B logs, *Appendix D* for time data).

As well, this command must be properly initialized before the GPSCard can operate as a GPS pseudorange reference station. Once initialized, the receiver will compute pseudorange differential corrections for each satellite being tracked. The computed differential corrections can then be output to remote stations by utilizing any of the following GPSCard differential corrections data log formats: RTCM, RTCMA, RTCMB, CMR, RTCA, RTCAA or RTCAB. The reference station servicing RT-20 remote receivers must log RTCM3 and RTCM59(N) pseudorange and carrier- phase observation data in order for the RT-20 remote receiver to compute double difference carrier phase solutions.

The values entered into the FIX POSITION command should reflect the precise position of the reference station antenna phase centre. Any errors in the FIX POSITION coordinates will directly bias the pseudorange corrections calculated by the reference receiver.

The GPSCard performs all internal computations based on WGS84 and the datum command is defaulted as such. The datum in which you choose to operate (by changing the DATUM command) will internally be converted to and from WGS84. Therefore, all differential corrections are based on WGS-84, regardless of your operating datum.

The GPSCard will begin logging differential data while tracking as few as three healthy satellites. See *Appendix A* for further discussions on differential positioning.

The FIX POSITION command will override any previous FIX HEIGHT or FIX POSITION command settings. Use the UNFIX command to disable the FIX POSITION setting.

Syntax:

FIX POSITION

Syntax	Range Value	Description	Default	Example
FIX POSITION	-	Command	unfix	fix position
lat	0 to ± 90.0 (Up to 8 decimal places are shown in the RCCA log but more precision is determined internally)	Latitude (in degrees/decimal degrees) of fixed reference station antenna in current datum. A negative sign implies South latitude.		51.3455323
lon	0 to ± 360.0 (Up to 8 decimal places are shown in the RCCA log but more precision is determined internally)	Longitude (in degrees) of fixed reference station antenna in current datum. A negative sign implies West longitude.		-114.289534
height	-1,000 to 20,000,000	Height (in metres) above the geoid of reference station in current datum.		1201.123
station id	0 to 1023 (10 bits) for RTCM output "xxxx" for RTCA output where "xxxx" are four alphanumeric characters, entered between double quotes. For CMR, the station ID should be ≤ 31.	Specify a reference Station identification number (<i>optional entry</i>) (see <i>SETDGPSID</i>)		1002
RTCM reference station health	0-7 where 0-5 Specified by user 6 Reference station transmission not monitored 7 Reference station not working	Specify RTCM reference station health (<i>optional</i>) (This field will only be reported in RTCM message header - word 2.)	6	0

Example:

```
fix position 51.3455323,-114.289534,1201.123,1002,0
```

The above example configures the receiver as a reference station with fixed coordinates of:

```
Latitude N 51° 20' 43.9163" (WGS84 or local datum)
Longitude W 114° 17' 22.3224"
Height above sea level 1201.123 meters
Station ID 1002
RTCM health 0
```

FIX VELOCITY

This command supports INS (Inertial Navigation System) integration. It accepts ECEF XYZ velocity values in units of meters per second (m/s). This information is only used by the tracking loops of the receiver to aid in reacquisition of satellites after loss of lock, otherwise it is ignored. It is not used in the position solution and velocity calculations. This command is only useful for very high dynamics where expected velocity changes during the signal blockage of more than 100 meters per second can occur. See *Figure D-2* for ECEF definitions. The UNFIX command is used to clear the effects of the FIX VELOCITY command. The FIX VELOCITY command will override any previous FIX HEIGHT or FIX POSITION command. Use the UNFIX command to disable the current FIX command.

Syntax:

FIX VELOCITY

Syntax	Range Value	Description	Default	Example
FIX VELOCITY	-	Command	unfix	fix velocity
vx	±999.99	X = Antenna Velocity (ECEF) in the X direction [m/s].		315
vy	±999.99	Y = Antenna Velocity (ECEF) in the Y direction [m/s].		212
vz	±999.99	Z = Antenna Velocity (ECEF) in the Z direction [m/s].		150

Example:

```
fix velocity 315,212,150
```



FREQUENCY_OUT

This command allows the user to specify the frequency of the output pulse train available at the variable frequency (VARF) pin of the I/O strobe connector. This command has no effect on the operation of the GPSCard; it is only provided for user-determined applications.

The frequency (in Hertz) is calculated according to formulas which require two input parameters (k and p), such that:

$$\text{if } k=1 \text{ or } p=1: \quad \text{VARF} = 0$$

$$\text{if } k \neq 1, p \neq 1: \quad \text{VARF} = \frac{Fs \times 19,999}{20,000 \times k \times p}$$

Where:

Fs is the TCXO frequency = 20.000 MHz

k is an integer from 2 to 65536

p is an integer from 2 to 1024

The possible range of output frequencies is 0 - 5 MHz.

The resultant waveform is composed of active-high pulses with a repetition rate as defined above, and a jitter of 50 ns unless k equals 19 999, see the table below for Syntax 1.

$$\text{The pulse width (seconds)} = 1 / [(Fs \times 19999) / (20000 \times k)]$$

The command has two syntactical forms. One is to define a frequency, and the other is to disable this function.

Syntax 1:

FREQUENCY_OUT

Command	Range Values	For Jitter Free Operation	Description
FREQUENCY_OUT	-	-	Command
K	1 - 65 536	19 999	Variable integer
P	1 - 1 024	2 - 1 024	Variable integer

Example:

```
frequency_out 4,8
```

Syntax 2:

FREQUENCY_OUT

Command	Range Values	Description
FREQUENCY_OUT	-	Command
keyword	disable	The keyword "DISABLE" is the only one defined at this time.

FRESET

This command clears all data which is stored in non-volatile memory. Such data includes the almanac, satellite channel configuration, and any user-specific configurations. The GPSCard is forced to reset and will start up with factory defaults.

See also the CRESET, where the differences between these three commands are explained, and RESET commands.

Syntax:

FRESET



HELP

This command provides you with on-line help. The command, with no options, gives a complete list of the valid system commands. For detailed help on any command, append the optional command name to the HELP command.

Syntax:

HELP option

OR:

? option

Syntax	Range Value	Description
HELP (or ?)	-	Entering HELP without an option will list all valid command options.
option	See <i>Figure C-1</i>	Can be any valid system command. Information about the command entered will be displayed.

Example:

```
help dynamics
```

Figure C-1 shows the screen display of the HELP command as it would be seen if you were using NovAtel's graphical interface program *GPSolution*. *Figure C-2* shows a specific example of the ASSIGN command appended to the HELP command.

Figure C-1 HELP Command Screen Display

```
Com1> help
?-Online Command Help
ANTENNAPOWER -Antenna Power Control
CLOCKADJUST -Adjust 1pps
COM2 -Initialize Port 2
COM2_DTR -DTR Control on Port 2
COM2_RTS -RTS Control on Port 2
CRESET -Factory Config Reset
DATUM -Choose a DATUM Type
DIFF_PROTOCOL -Diff. protocol control
ECUTOFF -Elevation Cutoff Angle
FIX -Set Antenna Coord.
FREQUENCY OUT -Variable Freq. Output
LOCKOUT -Lock Out Satellite
MAGVAR -Set Magnetic Variation.on
POSAVE -Position Averaging
RESETHEALTH -Reset PRN Health
RESETRT20 -Reset RT20 algorithm
RINEX -RINEX Configuration
RTCMRULE -RTCM Bit Rule
SAVECONFIG -Save User Config.
SENDHEX -Send hex to a port
SETHEALTH -Overr.ide PRN Health
SETNAV -Set a Destination
UNASSIGN -Un-Assign a Channel
UNDULATION -Choose Undulation
UNLOCKOUT -Restore Satellite
UNLOG -Kill a Data Log
USERDATUM -User Defined DATUM
Com1>
ACCEPT -Accept Datatypes
ASSIGN -Assign PRN To a Chan.
COM1 -Initialize Port 1
COM1_DTR -DTR Control on Port 1
COM1_RTS -RTS Control on Port 1
CONFIG -Configure Satellites
CSMOOTH -Carrier Smoothing
DGPSTIMEOUT -Max. aye of DGPS data
DYNAMICS -Set Dynamics
EXTERNALCLOCK -Specify Clock type
RESET -Factory Card Reset
HELP -Online Command Help
LOG -Choose Date Logging
MESSAGES -Error Messages On/Off
RESET -Hardware Reset
RESETHEALTHALL -Reset All PRE Health
RTKMODE -Set RTK parameters
RTCM16T -Input Type I6 Message
SAVEALMA -Save Almanac & ION/UTC
SEND -Send string to a port
SETDGPSID -Set the Station ID
SETL10FFSET -Set LI PSR Offset
SETTIMESYNC -Enable/Disable Timesync
UNASSIGNALL -Un-Assign All Channels
UNFIX -Remove Recvr. FIX(ed)
UNLOCKOUTALL -Select All Satellites
UNLOGALL -Kill all Data Logs
VERSION -Current Software Vet.
```

Figure C-2 Appended Command Screen Display

```
COM2> help assign
ASSIGN Channel_no, PRN, Doppler, Dop_window
Assign a prn to a channel
where:
Channel_no = A channel number from 0-23
PRN = A satellite PRN number from 1-32
Doppler = Current satellite doppler offset (-100000 to +100000 Hz)
Dop_window = Uncertainty in doppler estimate (0 to 10000 Hz)
COM2>
```

IONOMODEL

This command allows the user to dictate what ionospheric corrections the card uses. This command currently does not effect the ionospheric model that is used when the card is operating in RTK mode. Additional range values are reserved for future use.

The MiLLennium by default computes ionospheric corrections by attempting to use L1 & L2 signals first. To use the ionospheric corrections issued by the WAAS GEO satellite as a first choice, you need to issue the IONOMODEL WAAS command with the appropriate parameters.

Syntax:

IONOMODEL [keyword]

Syntax	Range Value	Description
IONOMODEL	-	Command
keyword	WAAS ^a	Card will use ionospheric corrections from WAAS broadcast messages. as a first choice. You must first ensure that your receiver is capable of accepting WAAS corrections, see the CONFIG and WAASCORRECTION commands on <i>Pages 88 and 137</i> respectively.
	L1L2 ^b	Card will use ionospheric corrections derived from L1 and L2 GPS measurements as a first choice. Card must have L2 observations in order for this setting to be effective.
	KLOBUCHAR ^{b,c}	Card will use ionospheric corrections as calculated by the broadcast klobuchar model parameters as a first choice.
	AUTO ^d	Card will decide which ionospheric corrections to use based on availability. (default)

- a. This keyword is only available on WAAS/EGNOS enabled models.
- b. These keywords are not available in versions of software prior to 4.52.
- c. Please refer to ICD-GPS-200 for a description of the Klobuchar model and its parameters. To obtain copies of ICD-GPS-200, see *Appendix F Standards and References on Page 239*, for address information.
- d. In software version 4.503 and earlier, this keyword is referred to as CALCULATED.

LOCKOUT

This command will prevent the GPSCard from using a satellite by de-weighting its range in the solution computations. Note that the LOCKOUT command does not prevent the GPSCard from tracking an undesirable satellite. This command must be repeated for each satellite to be locked out.

See also the UNLOCKOUT and UNLOCKOUTALL commands.

Syntax:

```
LOCKOUT prn
```

Syntax	Range Value	Description	Default
LOCKOUT	-	Command	unlockoutall
prn	1 - 32	A single satellite PRN integer number to be locked out	

Example:

```
lockout 8
```

LOG

Many different types of data can be logged using several different methods of triggering the log events. Every log element can be directed to either the COM1 or COM2 ports. If a selected log element is to be directed to all the ports, then separate LOG commands are required to control them. The ONTIME trigger option requires the addition of the *period* parameter and optionally allows input of the *offset* parameter. See *Chapter 3* and *Appendix D* for further information and a complete list of ASCII and Binary data log structures.

The optional parameter *{hold}* will prevent a log from being removed when the UNLOGALL command is issued. To remove a log which was invoked using the *{hold}* parameter requires the specific use of the UNLOG command.

The *[port]* parameter is optional. If *[port]* is not specified, *[port]* is defaulted to the port that the command was received on.

Syntax:

```
LOG [port] [datatype] [trigger] [period] [offset] {hold}
```

Example:

```
log com1,posa,ontime,60,1,hold
```

The above example will cause the POSA log to be logged to COM port 1, recurring every 60 seconds, offset by one second, and with the *{hold}* parameter set so that logging would not be disrupted by the UNLOGALL command.

To send a log only one time, the trigger option can be ignored.

Example:

```
log com1 posa
log posa
```

MAGVAR

The GPSCard computes directions referenced to True North. Use this command (magnetic variation correction) if you intend to navigate in agreement with magnetic compass bearings. The correction value entered here will cause the "bearing" field of the NAVA/B and GPVTG logs to report bearing in degrees Magnetic. The magnetic variation correction is also reported in the GPRMC log. The GPSCard will compute the magnetic variation correction if you use the auto option.

Syntax:

MAGVAR

OR

MAGVAR

Syntax	Range Value	Description	Default
MAGVAR	-	Command	
correction	± 0 - 180	The magnetic variation correction for the area of navigation in units of degrees. Magnetic bearing = True bearing + Magnetic Variation Correction See <i>Figure C-3</i> .	0.0
std_dev	± 0 - 180	Option: the estimated accuracy of the magnetic correction entered (in degrees). This option is currently not applicable to this product.	
auto		The GPSCard calculates values of magnetic variation for given values of latitude, longitude and time using the International Geomagnetic Reference Field (IGRF) 95 spherical harmonic coefficients, and IGRF time corrections to the harmonic coefficients.	

Example:

```
magvar +15.0
```

Figure C-3 Illustration of Magnetic Variation & Correction

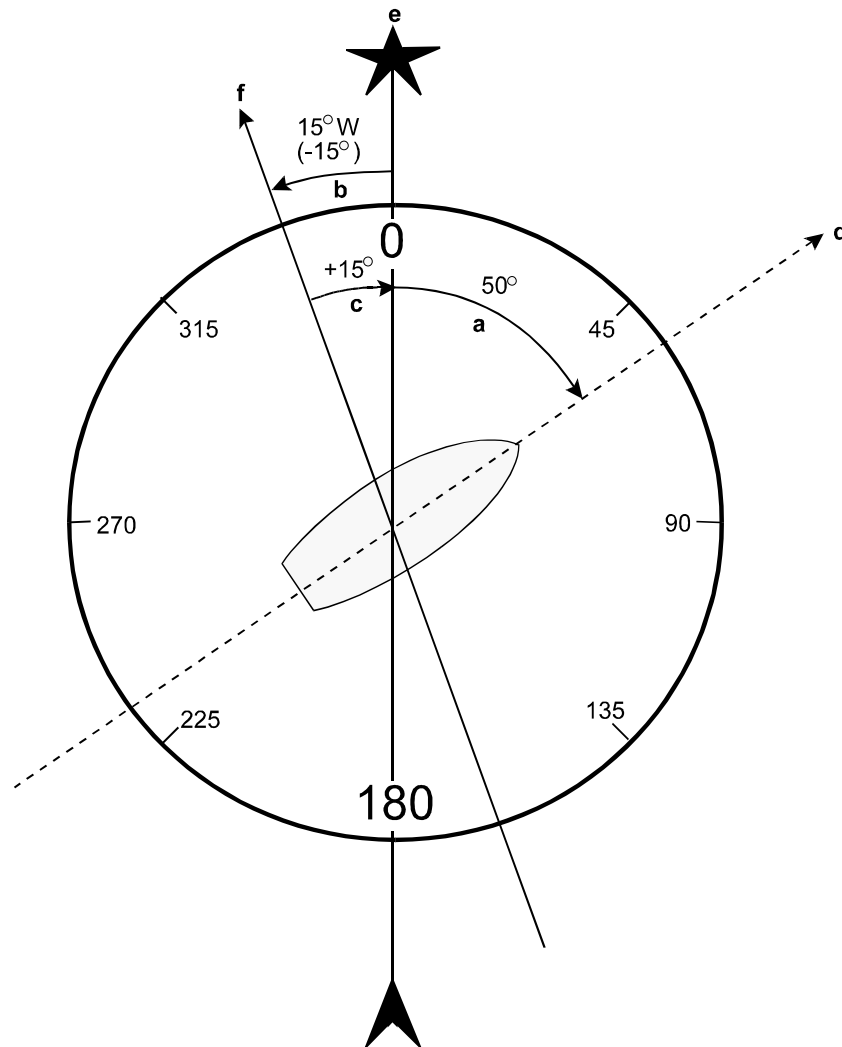

Reference	Description
a	True Bearing
b	Local Magnetic Variation
c	Local Magnetic Variation Correction (inverse of magnetic variation)
a + c	Magnetic Bearing
d	Heading: 50° True, 60° Magnetic
e	True North
f	Local Magnetic North

MESSAGES

The MESSAGES command is used to disable the port prompt and error message reporting from a specified port. This feature can be useful if the port is connected to a modem or other device that responds with data the GPSCard does not recognize. See *Chapter 3* for further information on using this command with Special Pass-Through Logs.

Syntax:

```
MESSAGES  
```

Syntax	Range Value	Description	Default
MESSAGES	-	Command	MESSAGES
port	COM1, COM2 or all	Specifies the port being controlled	-
option	ON or OFF	Enable or disable port prompt and error message reporting	ON

Example:

```
messages com1,off
```

POSAVE

This command implements position averaging for reference stations. Position averaging will continue for a specified number of hours or until the averaged position is within specified accuracy limits. Averaging will stop when the time limit or the horizontal standard deviation limit or the vertical standard deviation limit is achieved. When averaging is complete, the FIX POSITION command will automatically be invoked.

If the maximum time is set to 1 hour or larger, positions will be averaged every 10 minutes and the standard deviations reported in the PAVA/B log should be correct. If the maximum time is set to less than 1 hour, positions will be averaged once per minute and the standard deviations reported in the log will likely not be accurate; also, the optional horizontal and vertical standard deviation limits cannot be used.

One could initiate differential logging, then issue the POSAVE command followed by the SAVECONFIG command. This will cause the GPSCard to average positions after every power-on or reset, then invoke the FIX POSITION command to enable it to send differential corrections.

Syntax:

```
POSAVE   
```

Command	Range Values	Description
POSAVE	-	Command
maxtime	0.025 - 100	Maximum amount of time that positions are to be averaged (hours). 1.5 to 60 minutes
mashorstd	0.1 - 100	Option: desired horizontal standard deviation (m)
maxverstd	0.1 - 100	Option: desired vertical standard deviation (m)

Example:

```
posave 2,3,4
```

RESET

This command performs a hardware reset. Following a RESET command, the GPSCard will initiate a cold-start bootup. Therefore, the receiver configuration will revert to the factory default if no user configuration was saved or the last SAVECONFIG settings.

Syntax:

RESET

See also the CRESET, where the differences between these three commands are explained, and FRESET commands.

RESETHEALTH

This command cancels the SETHEALTH command and restores the health of a satellite to the broadcast value contained in the almanac and ephemeris data.

Syntax:

RESETHEALTH

Syntax	Range Value	Description
RESETHEALTH	-	Command
prn	1 - 32	The PRN integer number of the satellite to be restored.

Example:

```
resethealth 4
```

RESETHEALTHALL

This command resets the health of all satellites to the broadcast values contained in the almanac and ephemeris data.

Syntax:

```
RESETHEALTHALL
```

RINEX

The Receiver-Independent Exchange format (RINEX) is a broadly-accepted, receiver-independent format for storing GPS data. It features a non-proprietary ASCII file format that can be used to combine or process data generated by receivers made by different manufacturers. RINEX was originally developed at the Astronomical Institute of the University of Berne. Version 2, containing the latest major changes, appeared in 1990; subsequently, minor refinements were added in 1993. To date, there are three different RINEX file types: observation files, broadcast navigation message files and meteorological data files.

Please see *Chapter 4* for further details.

RTCM16T

This is a NovAtel command relating to the RTCM Standard ASCII message that can be sent out in RTCM Type 16 format. Once created, the RTCM16T message can be viewed in the RCCA command settings list. The text message can also be logged using the RTCM16 or RTCM16T log option. This command will limit the input message length to a maximum of 90 ASCII characters.

See *Chapter 4*, for related topics.

RTCMRULE

This command allows the user flexibility in the usage of the RTCM Standard "bit rule".

See *Chapter 4*, for further information.

RTKMODE

This command sets up the RTK (RT-2 or RT-20) mode. Invoking this command allows you to set different parameters and control the operation of the RTK system. The RTKMODE command is actually a family of commands; a description of the various arguments and options is as follows. Some arguments require data input, while others do not.

Certain arguments can be used only at the reference station, and others only at the remote station. The structure of the syntax is shown below, followed by a detailed description of each argument.

Syntax - Reference Station

For RTCA-format messaging only:

```
RTKMODE sv_entries 4to 20
```

```
RTKMODE elev_mask 0to 90
```

Command	Argument	Data Range	Default
RTKMODE			
	sv_entries	4 to 20	12
	elev_mask	0 to 90	2

For RTCM-format messaging only:

```
RTKMODE rtcver 2.1 or 2.2
```

Command	Argument	Data Range	Default
RTKMODE			
	rtcver	2.1 or 2.2	2.2

Syntax - Remote Station (for RTCA, RTCM or CMR-format messaging):

```
RTKMODE default
```

```
RTKMODE enable
```

```
RTKMODE disable
```

```
RTKMODE reset
```

```
RTKMODE auto
```

```
RTKMODE static
```

```
RTKMODE kinematic
```

```
RTKMODE fixed
```

```
RTKMODE float
```

```
RTKMODE unknown_baselines
```

```
RTKMODE known_llh_position lat lon hgt [2σ] [m/e]
```

```
RTKMODE know_ecef_baseline Δx Δy Δz [2σ]
```

```
RTKMODE elev_mask 0 to 90
```



Command	Argument	Default Argument	Data Range
RTKMODE			
	default	default	
	enable <i>or</i> disable	enable	
	reset		
	auto, static <i>or</i> kinematic	auto	
	fixed <i>or</i> float	fixed	
	unknown_baseline, known_llh_position <i>lat,lon,hgt,[2σ],[m/e]</i> <i>or</i> known_ecef_baseline $\Delta x, \Delta y, \Delta z, [2\sigma]$	unknown_baseline	<i>lat:</i> 0 to ± 90 <i>lon:</i> 0 to ± 360 <i>hgt:</i> -1000 to +20 000 000 <i>2σ:</i> 0 to 0.03 <i>m/e:</i> m <i>or</i> e (<i>m</i> = default) $(\Delta x)^2 + (\Delta y)^2 + (\Delta z)^2 \leq (1\,000\,000)^2$ <i>2σ:</i> 0 to 0.03

Below is additional information for each argument:

Station	Command	Argument	Data
Reference	rtkmode	elev_mask	elevation (range 0 to 90, default = 2)
<p>RTKMODE ELEV_MASK ELEVATION causes transmission of observations for satellites above this elevation angle only. The elevation angle has units of degrees, and can be a decimal fraction value. At this time, this command affects RTCAOBS (RTCA Type 7) messages but not RTCM or CMR messages; if RTCM-format messaging is being used, then observations for a certain satellite are transmitted as soon as it becomes visible.</p> <p>Example:</p> <pre>rtkmode elev_mask 10.5</pre>			
Remote	rtkmode	elev_mask	elevation (range 5 to 90, default = 12)
<p>When RTKMODE ELEV_MASK ELEVATION is issued at the remote, it controls the elevation angle above which satellites will be fully weighted. A value of 5° or less will be ignored. If you want the RTK unit to use low elevation satellites, you can enter a value greater than 5° but less than 12° to override the default of 12°. Also, if there is low satellite coverage, the RTK mask angle will automatically drop to as low as 9.5° in an attempt to pick up more satellites. This command can be used at the remote regardless of the type of inter-receiver messages used.</p>			
Station	Command	Argument	
Remote	rtkmode	default	
<p>RTKMODE DEFAULT, when issued at the remote station, all RTK parameters are returned to their default values.</p>			
Station	Command	Argument	
Remote	rtkmode	enable (default) disable	
<p>RTKMODE ENABLE, when issued at the remote station, turns on its ability to receive and process RTCA or RTCM messages. RTKMODE DISABLE exits the RTK positioning mode.</p>			
Station	Command	Argument	Data
Reference	rtkmode	rtcmver	2.1 2.2 (default)
<p>For RTCM-format messaging only, at the reference station, when issued determines what RTCM version to use.</p> <p>Note: The remote station can use either version 2.1 or 2.2 without the use of this command.</p>			

Station	Command	Argument	Data
Remote	rtkmode	unknown_baseline (default)	
		known_llh_position	lat,lon,height,[2σ],[m/e]
		known_ecef_baseline	Δx, Δy, Δz,[2σ]

RTKMODE UNKNOWN_BASELINE prevents the RTK system from using any baseline information in the initial calculation of ambiguities. It cancels the effect of the RTKMODE KNOWN_LLH_POSITION or RTKMODE KNOWN_ECEF_BASELINE command. It indicates to the RT-2 software that the previously entered baseline can no longer be considered valid, usually because the antenna is starting to move.

RTKMODE KNOWN_LLH_POSITION LAT,LON,HEIGHT,[2σ],[M/E] requires the latitude, longitude and height of the initial remote station antenna location. It can be used to initialize the RT-2 algorithms from a known antenna position. It speeds up ambiguity resolution by indicating to the RT-2 software the exact length of the vector between the remote and reference station antennas. It only affects the operation of an RT-2 system on baselines not exceeding 30 km. *LAT* requires a decimal fraction format; a negative sign implies South latitude. *LON* requires a decimal fraction format; a negative sign implies West longitude. *HEIGHT* (in meters) can refer either to mean sea level (default) or to an ellipsoid. The optional 2σ defines the accuracy (2 sigma, 3 dimensional) of the input position, in meters; it must be 0.03 m or less to cause the RT-2 algorithms to undergo a forced initialization to fixed integer ambiguities. If no value is entered, a default value of 0.30 m is assumed; this will not cause an initialization to occur. The optional *M* or *E* refers to the height: if “M” is entered, the height will be assumed to be above mean sea level (MSL). Note that when an MSL height is entered, it will be converted to ellipsoidal height using the NovAtel internal undulation table or the last value entered with the “UNDULATION” command. You may directly indicate an ellipsoidal height by using the optional “E” flag.

Example:

```
rtkmode known_llh_position 51.113618,-114.04358,1059.15,0.01,e
```

RTKMODE KNOWN_ECEF_BASELINE ΔX,ΔY,ΔZ,[2σ] can be used to initialize the RT-2 algorithms from a known ECEF baseline. The RT-2 system uses this to initialize its ambiguities. It only affects the operation of an RT-2 system on baselines not exceeding 30 km. The ΔX,ΔY,ΔZ values represent the remote station’s position minus the reference position, along each axis, in meters. The optional 2σ defines the accuracy (2 sigma, 3 dimensional) of the input baseline, in meters; it must be 0.03 m or less to cause the RT-2 algorithms to do a forced initialization to fixed integer ambiguities. If no value is entered, a default value of 0.30 m is assumed; this will not cause an initialization to occur.

Example:

```
rtkmode known_ecef_baseline 3583,2165,567,0.02
```

NOTE: You must be very careful when using these last two commands; erroneous input will cause poor performance and/or erroneous output. It is also very important to follow these command with an RTKMODE UNKNOWN_BASELINE command before any motion begins.

Station	Command	Argument
Remote	rtkmode	auto (default) static kinematic
<p>RTKMODE AUTO configures the RTK system to automatically detect motion. It is the default mode. It will reliably detect motion of 2.5 cm/sec or greater. If you are undergoing motion slower than this which covers more than 2 cm, you should use the manual mode selection commands (static and kinematic).</p> <p>RTKMODE STATIC forces the RTK software to treat the remote station as though it were stationary, regardless of the output of the motion detector.</p> <hr/> <p>NOTE: For reliable performance the antenna should not move more than 1 - 2 cm when in static mode.</p> <hr/> <p>RTKMODE KINEMATIC forces the RTK software to treat the remote station as though it were in motion, regardless of the output of the motion detector. If the remote station is undergoing very slow steady motion (< 2.5 cm/sec for more than 5 seconds), you should declare KINEMATIC mode to prevent inaccurate results and possible resets.</p>		

Station	Command	Argument
Remote	rtkmode	fixed (default) float
<p>RTKMODE FIXED tells the RTK system to use fixed discrete ambiguities whenever the system is capable and can do so reliably; it may never do so for long baselines or poor geometries. Only RT-2 systems are capable of fixing ambiguities, so issuing this command on an RT-20 system will have no effect.</p> <p>RTKMODE FLOAT causes the system to compute only a floating ambiguity solution. L2 data will be used along with L1 data if the system is capable of generating L2 data.</p> <p>You can force the RT-2 software to <i>not</i> fix ambiguities when it normally would, but you cannot force it to fix ambiguities when it normally wouldn't.</p>		

Station	Command	Argument
Remote	rtkmode	reset
<p>RTKMODE RESET causes the RTK algorithm (RT-20 or RT-2, whichever is active) to undergo a complete reset, forcing the system to restart the ambiguity resolution calculations.</p>		

Station	Command	Argument	Data
Reference	rtkmode	sv_entries	number (range 4 to 20, default = 12)
<p>RTKMODE SV_ENTRIES NUMBER causes the number of satellite measurements to be limited to the number indicated. <i>NUMBER</i> refers to the number of PRNs transmitted by the reference station; each PRN can have either an L1-only measurement or an L1/L2 pair of measurements. At this time, this command affects RTCAOBS (RTCA Type 7) messages but not RTCM or CMR messages; if RTCM-format messaging is being used, then observations for all visible satellites are transmitted.</p> <p>Example:</p> <pre>rtkmode sv_entries 8</pre>			

SAVEALMA

This command saves the latest almanac in non-volatile memory.

The option `ONNEW` is the default; if a different setting is used, a `SAVECONFIG` command must be issued or else `ONNEW` will resume after a reset.

Bit 21 in the receiver self-test status word (see *Table D-5, Page 198*) indicates whether the latest almanac received by the GPS receiver is newer than the almanac saved in non-volatile memory (NVM).

Syntax:

```
SAVEALMA option
```

Command	Range Values	Description	Default
SAVEALMA	-	Command	
option	onnew	Each almanac is saved in NVM upon reception if it is newer than the one already stored. This will occur continuously.	onnew
	stop	Stops auto saving.	
	disable ^①	Stops auto saving and prevents the use of the almanac, saved in NVM, on startup.	

^①The disable option must be followed by the `SAVECONFIG` command to have an effect.

SAVECONFIG

This command saves the user's present configuration in non-volatile memory.

WARNING!: Do not use the SAVECONFIG command when communicating with the GPSCard through GPSolution.

Syntax:

SAVECONFIG

SEND

This command is used to send ASCII printable data from the COM1 or COM2 or disk file to a specified communications port. This is a one-time command, therefore the data message must be preceded by the SEND command followed by the <Enter> key (<CR><LF>) each time you wish to send data. (Remember to use the MESSAGES command to disable error reporting whenever two GPSCards are connected together via the COM ports.)

Syntax:

```
SEND  
```

Syntax	Range Value	Description
SEND		Command
to-port	COM1, COM2	Port option
data	up to 100 characters	ASCII data

Scenario: Assume that you are operating GPSCards as reference and remote stations. It could also be assumed that the reference station is unattended but operational and you wish to control it from the remote station. From the remote station, you could establish the data link and command the reference station GPSCard to send differential corrections.

Figure C-4 Using SEND Command

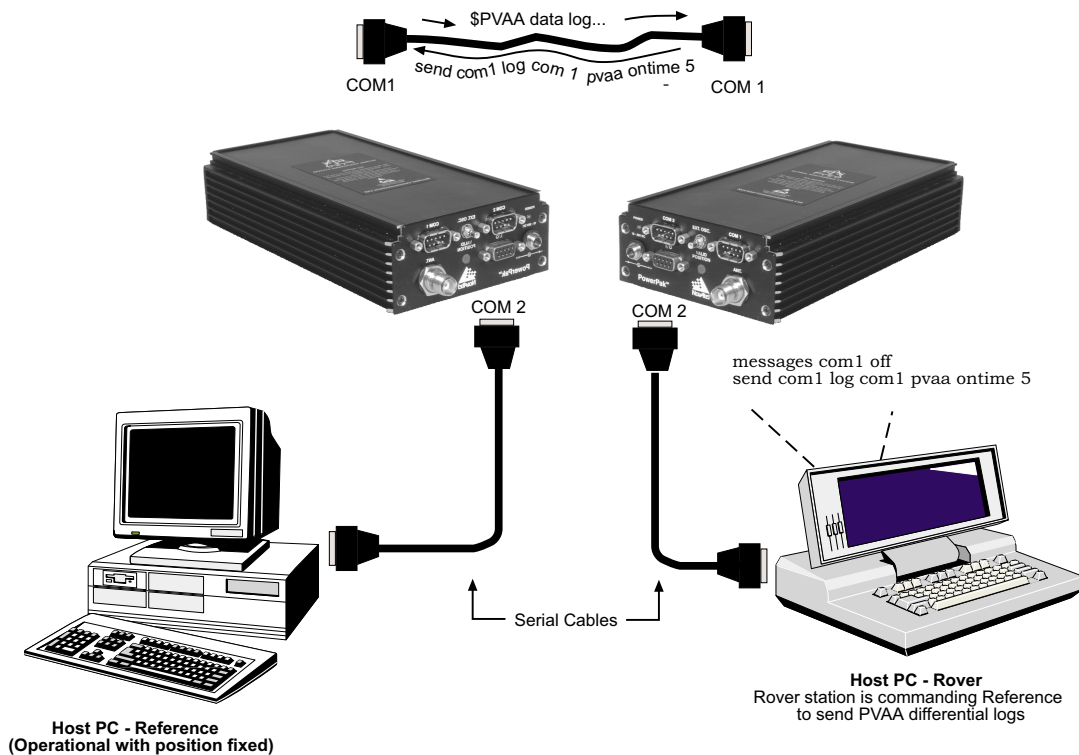

SENDHEX

This command is like the SEND command but is used to send non-printable characters expressed as hexadecimal pairs.

Syntax:

```
SENDHEX  
```

Syntax	Range Value	Description
SENDHEX		Command
to-port	COM1, COM2	Port option
data	<ul style="list-style-type: none"> • even number of ASCII characters from set of 0-9, A-F • spaces allowed between pairs of characters • carriage return & line feed provided by entering ODOA at end of string • maximum number of characters limited to about 1400 characters by command interpreter buffer (2800 ASCII characters pairs) 	ASCII data

SETDGPSID

This command is used to enter a station ID. Once set, the receiver will only accept differential corrections from a station whose ID matches the set station ID. It is typically used when a station has data links containing RTCM or RTCA messages from several stations. By entering a specific station ID, the operator can select which station to listen to. Having set a station ID, incoming, RTCM, RTCMA, RTCA, RTCAA, and RTCAB messages will be received from only that station. When a valid station ID is entered, an improved data synchronization algorithm will be used. It is recommended to always set the station ID. This command can also be used to set the station ID for a GPSCard reference station. See FIX POSITION 4th parameter (*station ID*).

Syntax:

```
SETDGPSID 
```

```
SETDGPSID 
```

Syntax	Range Value	Description	Default
SETDGPSID		Command	
station ID #	0 - 1023 or "xxxx"	Reference station ID number for RTCM Reference station name for RTCA where "xxxx" are four alphanumeric characters, entered between double quotes	all
	0 - 31 or all	Reference station ID number for CMR Accepts differential corrections from any station	

Example 1: SETDGPSID 1023

Example 2: SETDGPSID "abcd"

SETHEALTH

This command permits you the flexibility to override the broadcast health of a satellite. Under certain conditions and applications, it may be desirable to track and use information from a GPS satellite even though its health has been set bad by the GPS control segment. To SETHEALTH for more than one satellite, the command must be re-issued for each satellite.

IMPORTANT: *There is usually a reason when the GPS Control Segment sets a satellite to bad health condition. If you decide to ignore the health warnings and use the satellite information, UNPREDICTABLE ERRORS MAY OCCUR.*

Syntax:

SETHEALTH

Syntax	Range Value	Description	Default
SETHEALTH	-	Command	resethealthall
prn	1 - 32	A satellite PRN integer number	
health	good or bad	Desired health;	

Example:

```
sethealth 4,good
```

SETL1OFFSET

The characteristic signal delays introduced by the antenna, coaxial cable and GPSCard RF section will vary from one system configuration to another. These delays are measurable using external test equipment. For applications which involve very precise time transfer, or where ranges are used from multiple receivers, it may be necessary to add an offset to the L1 pseudorange to compensate for these delays. This is equivalent to a system calibration in that it corrects for inter-receiver range bias.

It does not affect the output position, and it is unrelated to data latencies.

NOTE: This feature is to be used by advanced users only.

Its intended application is for use in multi-card systems, in which case the clocks on the different GPSCards must be synchronized. The command is not necessary for most applications.

Syntax:

```
SETL1OFFSET 
```

Command	Range Values	Description
SETL1OFFSET	-	
distance	-10 to +10	Pseudorange offset (m)

Example:

```
setl1offset 1.348693
```



SETNAV

This command permits entry of one set of navigation waypoints (see *Figure C-5*). The origin (FROM) and destination (TO) waypoint coordinates entered are considered on the ellipsoidal surface of the current datum (default WGS84). Once SETNAV has been set, you can monitor the navigation calculations and progress by observing the NAVA/B, GPRMB, and GPZTG log messages.

Track offset is the perpendicular distance from the great circle line drawn between the FROM lat-lon and TO lat-lon waypoints. It establishes the desired navigation path, or track, that runs parallel to the great circle line, which now becomes the offset track, and is set by entering the track offset value in meters. A negative track offset value indicates that the offset track is to the left of the great circle line track. A positive track offset value (no sign required) indicates the offset track is to the right of the great circle line track (looking from origin to destination). See *Figure C-5* for clarification.

Syntax:

```
SETNAV    
  
SETNAV 
```

Syntax	Range Value	Description	Default	Example
SETNAV	-	Command		setnav
from-lat	0± 90	Origin latitude in units of degrees/decimal degrees. A negative sign implies South latitude. No sign implies North latitude.	disable	51.1516
from-lon	0± 360	Origin longitude in units of degrees/decimal degrees. A negative sign implies West longitude. No sign implies East longitude.		-114.16263
to-lat	0± 90	Destination latitude in units of degrees/decimal degrees		51.16263
to-lon	0± 360	Destination longitude in units of degrees/decimal degrees		-114.1516
track offset	0± 1000	Waypoint great circle line offset (in kilometers); establishes offset track; positive indicates right of great circle line; negative indicates left of great circle line		-125.23
from-port	1 to 5 characters	Optional ASCII station name		from
to-port	1 to 5 characters	Optional ASCII station name		to

Example:

```
setnav 51.1516,-114.16263,51.16263,-114.1516,-125.23,from,to
```

Figure C-5 Illustration of SETNAV Parameters

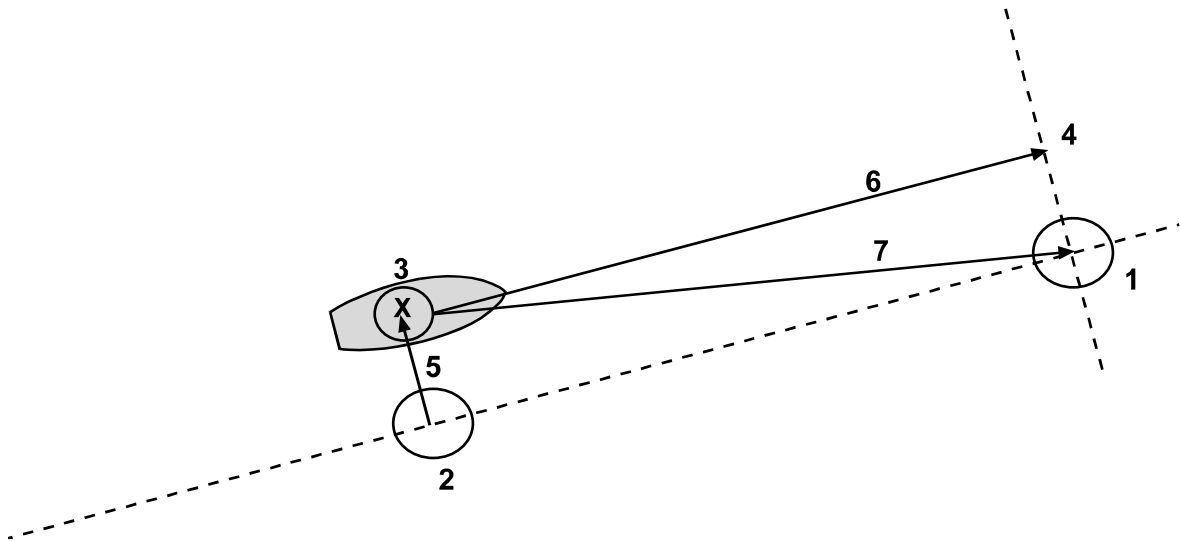

Reference	Description
1	TO, lat-lon
2	X-Track perpendicular reference point
3	Current GPS position
4	A-Track perpendicular reference point
5	X-Track (cross-track)
6	A-Track (along track)
7	Distance and bearing from 3 to 1

SETTIMESYNC

This command enables or disables time synchronization, which permits two GPSCards in a master/slave relationship to be synchronized to a common external clock for range comparisons. By default, this function is disabled.

With SETTIMESYNC enabled, a slave unit is able to interpret injected (\$)TM1A/B data messages; for more information, please refer to the comments relating to the (\$)TM1A/B special data messages, and the 1PPS signal.

Syntax:

```
SETTIMESYNC 
```

Command	Range of Values	Description	Default
SETTIMESYNC	-		
flag	enable or disable	Enable or disable time synchronization	disable

Example:

```
settimesync enable
```

NOTE: *This command is intended for advanced users of GPS only.*

UNASSIGN

This command cancels a previously issued ASSIGN command and the SV channel reverts to automatic control. If a SV channel has reached state 4 (PLL), the satellite being tracked will not be dropped when the UNASSIGN command is issued, unless it is below the elevation cut-off angle, and there are healthy satellites above the ecutoff that are not already assigned to other SV channels.

Syntax:

UNASSIGN

Syntax	Range Value	Description	Default
UNASSIGN	-	Command	unassignall
channel	0 - 11	Reset SV channel to automatic search and acquisition mode	

Example: `unassign 11`

UNASSIGNALL

This command cancels all previously issued ASSIGN commands for all SV channels. Tracking and control for each SV channel reverts to automatic mode. If any of the SV channels have reached state 4 (PLL), the satellites being tracked will not be dropped when the UNASSIGNALL command is issued, unless they are below the elevation cutoff angle, and there are healthy satellites above the ecutoff that are not already assigned to other SV channels.

Syntax: `UNASSIGNALL`

UNDULATION

This command permits you to either enter a specific geoidal undulation value or use the internal table of geoidal undulations. The separation values only refer to the separation between the WGS84 ellipsoid and the geoid, regardless of the datum chosen, see the PRTKA/B log in *Chapter 3* and *Appendix D*.

Syntax:

```
UNDULATION separation
```

Syntax	Range Value	Description	Default
UNDULATION	-	Command	
separation	table or enter a value	Selects the internal table of undulations and ignores any previously entered value. The internal table utilizes OSU - 89B 1.5° x ~1.5°. A numeric entry that overrides the internal table with a value in meters.	table

Example 1:

```
undulation table
```

Example 2:

```
undulation -5.6
```

Please see *Appendix A, A.2 Height Relationships* for a description of the relationships in *Figure C-6*.

Figure C-6 Illustration of Undulation

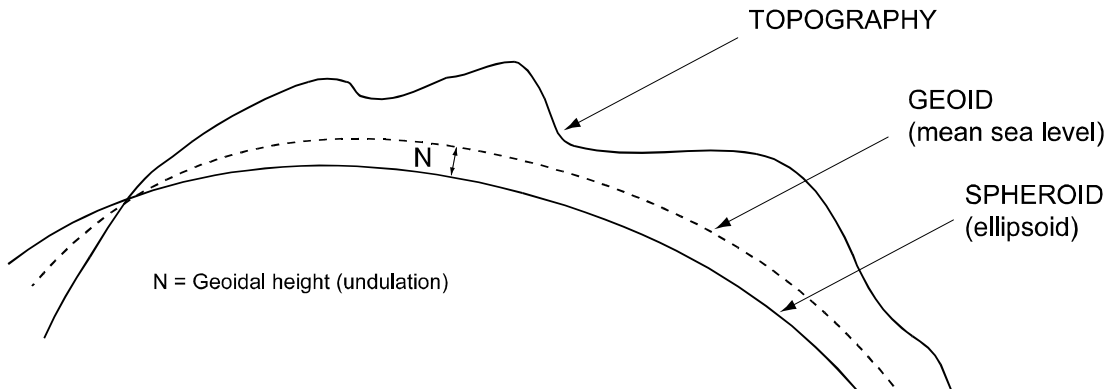

UNFIX

This command removes all position constraints invoked with any of the FIX commands (FIX POSITION, FIX HEIGHT, or FIX VELOCITY).

Syntax:

```
UNFIX
```

UNLOCKOUT

This command allows a satellite which has been previously locked out (LOCKOUT command) to be reinstated in the solution computation. If more than one satellite is to be reinstated, this command must be reissued for each satellite reinstatement.

Syntax:

```
UNLOCKOUT 
```

Syntax	Range Value	Description	Default
UNLOCKOUT	-	Command	unlockoutall
prn	1 - 32	A single satellite PRN to be reinstated	

Example:

```
unlockout 8
```

UNLOCKOUTALL

This command allows all satellites which have been previously locked out (LOCKOUT command) to be reinstated in the solution computation.

Syntax:

```
UNLOCKOUTALL
```

UNLOG

This command permits you to remove a specific log request from the system.

The *[port]* parameter is optional. If *[port]* is not specified, it is defaulted to the port that the command was received on. This feature eliminates the need for you to know which port you are communicating on if you want logs to come back on the same port you are sending commands on.

Syntax:

```
UNLOG [port] datatype
```

Syntax	Range Value	Description	Default
UNLOG	-	Command	unlogall
[port]	COM1, COM2	COMn port from which log originated	
datatype	any valid log	The name of the log to be disabled	

Example:

```
unlog com1,posa
unlog posa
```

UNLOGALL

If *[port]* is specified (COM1 or COM2) this command disables all logs on the specified port only. All other ports are unaffected. If *[port]* is not specified this command disables all logs on all ports.

Syntax:

```
UNLOGALL [port]
```

NOTE: This command does not disable logs that have the HOLD attribute (see description for LOG command). To disable logs with the HOLD attribute, use the UNLOG command.

USERDATUM

This command permits entry of customized ellipsoidal datum parameters. Use this command in conjunction with the DATUM command. The default setting is WGS84.

Syntax:

USERDATUM

Syntax	Range Value	Description	Default	Example
USERDATUM	-	Command		userdatum
semi-major	min. 6300000.0 max. 6400000.0	Datum Semi-major Axis (a) in metres	6378137.000	6378206.4
flattening	min. 290.0 max. 305.0	Reciprocal Flattening, $1/f = a/(a-b)$	298.257223563	294.9786982
dx,dy,dz	min. - 2000.0 max. 2000.0	Datum offsets from WGS84 in meters: These will be the translation values between your datum and WGS84 (internal reference)	0.000,0.000,0.000	-12,147,192
rx,ry,rz	min. -10 max. 10	Datum Rotation Angle about X, Y and Z axis (radians): These values will be the rotation between your datum and WGS84 where a positive value indicates a clockwise rotation and a negative value indicates a counter clockwise rotation.	0.000,0.000,0.000	0,0,0
scale	min. -10 max. 10	Scale value is the difference in ppm between your datum and WGS84	0.000	0

Example:

```
userdatum 6378206.4,294.9786982,-12,147,192,0,0,0,0
```

VERSION

Use this command to determine the current software version of the GPSCard. The response to the VERSION command is logged to the port from which the command originated.

Syntax:

```
VERSION
```

Command	Response Syntax					
VERSION	Card type	Model #	S/N	HW Rev	SW Rev	Date

Example:

```
version
OEM-3 MILLENRT2 CGL251448497 HW 3-1 SW 4.433/2.03 Feb 18/97
com1>
```

WAASCORRECTION WAAS

This command allows you to dictate how the card handles WAAS corrections. The card will switch automatically to Pseudorange Differential (RTCM or RTCA) or RTK if the appropriate corrections are being received, regardless of the current setting.

To enable the position solution corrections, you must issue the WAASCORRECTION ENABLE command.

Syntax:

```
WAASCORRECTION keyword [PRN] [mode]
```

Syntax	Range Value	Description
WAASCORRECTION	-	Command
keyword	ENABLE DISABLE	- Card will use the WAAS corrections it receives. - Card will not use the WAAS corrections that it receives.
[PRN]	120-138	- Card will use WAAS corrections from this PRN.
[mode]	NONE WAATESTMODE EGNOSTESTMODE	- Default. Card will interpret Type 0 messages as they are intended (as do not use). - Card will interpret Type 0 messages as Type 2. - Card will ignore the usual interpretation of Type 0 messages (as do not use) and continue.

Example 1:

```
waascorrection enable 122 waatestmode
```

Example 2:

```
waascorrection enable 120 egnostestmode
```

Example 3:

```
waascorrection disable
```

or

```
waascorrection enable none
```

In the first and second example the corrections are interpreted for WAAS and EGNOS respectively. In the third example the outcome is the same as setting the CONFIG command to STANDARD, where WAAS/EGNOS corrections are ignored.

D LOGS SUMMARY

LOG DESCRIPTIONS

ALMA/B Decoded Almanac

This log contains the decoded almanac parameters from subframes four and five as received from the satellite with the parity information removed and appropriate scaling applied. Multiple messages are transmitted, one for each SV almanac collected. The Ionospheric Model parameters (IONA) and the UTC time parameters (UTCA) are also provided, following the last almanac records. For more information on Almanac data, refer to the GPS SPS Signal Specification. (See *Appendix F* of this manual for *References*.)

MiLlennium cards will automatically save almanacs in their non-volatile memory (NVM), therefore creating an almanac boot file would not be necessary.

ALMA

Structure:

\$ALMA	prn	ecc	seconds	week	rate-ra
ra	w	Mo	af0	af1	cor-mean-motion
A	incl-angle	health-4	health-5	health-alm	*xx [CR][LF]

ALMA FORMAT

Field #	Field type	Data Description	Example
1	\$ALMA	Log header	\$ALMA
2	prn	Satellite PRN number for current message, dimensionless	1
3	ecc	Eccentricity, dimensionless	3.55577E-003
4	seconds	Almanac reference time, seconds into the week	32768
5	week	Almanac reference week (GPS week number)	745
6	rate-ra	Rate of right ascension, radians	-7.8860E-009
7	ra	Right ascension, radians	-6.0052951E-002
8	w	Argument of perigee, radians	-1.1824254E+000
9	Mo	Mean anomaly, radians	1.67892137E+000
10	a ⁰	Clock aging parameter, seconds	-1.8119E-005
11	a ¹	Clock aging parameter, seconds/second	-3.6379E-012
12	cor-mean-motion	Corrected mean motion, radians/second	1.45854965E-004
13	A	Semi-major axis, metres	2.65602281E+007
14	incl-angle	Angle of inclination, radians	9.55576E-001
15	health-4	Anti-spoofing and SV config (subframe 4, page 25)	1
16	health-5	SV health, 6 bits/SV (subframe 4 or 5, page 25)	0
17	health-alm	SV health, 8 bits (almanac)	0
18	*xx	Checksum	*20
19	[CR][LF]	Sentence terminator	[CR][LF]
1 - 19	\$ALMA	Next satellite PRN almanac message	
1 - 19	\$ALMA	Last satellite PRN almanac message	
1 - 11	\$IONA	Ionospheric Model Parameters	
1 - 11	\$UTCA	UTC Time Parameters	

Example:

```
$ALMA,1,3.55577E-003,32768,745,-7.8860E-009,-6.0052951E-002,-1.1824254E+000,
1.67892137E+000,-1.8119E-005,-3.6379E-012,1.45854965E-004,2.65602281E+007,
9.55576E-001,1,0,0*20[CR][LF]
...
$ALMA,31,4.90665E-003,32768,745,-8.0460E-009,3.05762855E+000,6.14527459E-001,
1.69958217E+000,6.67572E-006,3.63797E-012,1.45861888E-004,2.65593876E+007,
9.61664E-001,1,0,0*13[CR][LF]
```

IONA FORMAT

Structure:

\$IONA	act	a1ot	a2ot	a3ot	
bct	b1ot	b2ot	b3ot	*xx	[CR][LF]

Field #	Field type	Data Description	Example
1	\$IONA	Log header	\$IONA
2	act	Alpha constant term, seconds	1.0244548320770265E-008
3	a1ot	Alpha 1st order term, sec/semicircle	1.4901161193847656E-008
4	a2ot	Alpha 2nd order term, sec/(semic.) ²	-5.960464477539061E-008
5	a3ot	Alpha 3rd order term, sec/(semic.) ³	-1.192092895507812E-007
6	bct	Beta constant term, seconds	8.806400000000017E+004
7	b1ot	Beta 1st order term, sec/semicircle	3.276800000000010E+004
8	b2ot	Beta 2nd order term, sec/(semic.) ²	-1.96608000000001E+005
9	b3ot	Beta 3rd order term, sec/(semic.) ³	-1.96608000000001E+005
10	*xx	Checksum	*02
11	[CR][LF]	Sentence terminator	[CR][LF]

Example:

```
$IONA,1.0244548320770265E-008,1.4901161193847656E-008,-5.960464477539061E-008,
-1.192092895507812E-007,8.806400000000017E+004,3.276800000000010E+004,
-1.96608000000001E+005,-1.96608000000001E+005*02[CR][LF]
```

UTCA FORMAT**Structure:**

\$UTCA	pct	plot	data-ref	wk #-utc	wk #-lset
delta-time	lsop	day #-lset	*xx	[CR][LF]	

Field #	Field type	Data Description	Example
1	\$UTCA	Log header	\$UTCA
2	pct	Polynomial constant term, seconds	-2.235174179077148E-008
3	p1ot	Polynomial 1st order term, seconds/second	-1.243449787580175E-014
4	data-ref	UTC data reference time, seconds	32768
5	wk #-utc	Week number of UTC reference, weeks	745
6	wk #-lset	Week number for leap sec effect time, weeks	755
7	delta-time	Delta time due to leap sec, seconds	9
8	lsop	For use when leap sec on past, seconds	10
9	day #-lset	Day number for leap sec effect time, days	5
10	*xx	Checksum	*37
11	[CR][LF]	Sentence terminator	[CR][LF]

Example:

\$UTCA,-2.235174179077148E-008,-1.243449787580175E-014,32768,745,755,9,10,5*37
[CR][LF]

ALMB

ALMB FORMAT:

Message ID = 18 Message byte count = 120

Field #	Field Type	Bytes	Format	Units	Offset
1 (header)	Sync	3			0
	Checksum	1			3
	Message ID	4			4
	Message byte count	4			8
2	Satellite PRN number	4	integer		12
3	Eccentricity	8	double		16
4	Almanac ref. time	8	double	seconds	24
5	Almanac ref. week	4	integer	weeks	32
6	Omegadot - rate of right ascension	8	double	radians/second	36
7	Right ascension	8	double	radians	44
8	Argument of perigee	w 8	double	radians	52
9	Mean anomaly	Mo 8	double	radians	60
10	Clock aging parameter	af0 8	double	seconds	68
11	Clock aging parameter	af1 8	double	seconds/second	76
12	Corrected mean motion	8	double	radians/second	84
13	Semi-major axis	A 8	double	meters	92
14	Angle of inclination	8	double	radians	100
15	Sv health from subframe 4, discrete	4	integer		108
16	Sv health from subframe 5, discrete	4	integer		112
17	Sv health from almanac, discrete	4	integer		116

IONB FORMAT: Message ID = 16 Message byte count = 76

Field #	Field Type	Bytes	Format	Units	Offset
1 (header)	Sync	3	char		0
	Checksum	1	char		3
	Message ID	4	integer		4
	Message byte count	4	integer		8
2	Alpha constant term	8	double	seconds	12
3	Alpha 1st order term	8	double	sec/semicircle	20
4	Alpha 2nd order term	8	double	sec/(semic.) ²	28
5	Alpha 3rd order term	8	double	sec/(semic.) ³	36
6	Beta constant term	8	double	seconds	44
7	Beta 1st order term	8	double	sec/semic	52
8	Beta 2nd order term	8	double	sec/(semic.) ²	60
9	Beta 3rd order term	8	double	sec/(semic.) ³	68

UTCb FORMAT: Message ID = 17 Message Byte Count = 52

Field #	Field Type	Bytes	Format	Units	Offset
1 (header)	Sync	3	char		0
	Checksum	1	char		3
	Message ID	4	integer		4
	Message byte count	4	integer		8
2	Polynomial constant term	8	double	seconds	12
3	Polynomial 1st order term	8	double	seconds/second	20
4	UTC data reference time	4	integer	seconds	28
5	Week number UTC reference	4	integer	weeks	32
6	Week number for leap sec effect time	4	integer	weeks	36
7	Delta time due to leap sec	4	integer	seconds	40
8	For use when leap sec on past	4	integer	seconds	44
9	Day number for leap sec effect time	4	integer	days	48

BSLA/B Baseline Measurement RTK

This log contains the most recent matched baseline representing the vector from the reference station receiver to the remote station receiver. It is expressed in ECEF coordinates with corresponding uncertainties along each axis, and a time tag. The estimated variance of the baseline in ECEF XYZ coordinates is the same as the XYZ position variance.

It is recommended that you use the trigger 'on changed' which will log the selected data only when the data has changed.

BSLA

Structure:

\$BSLA	week	seconds	#sv	#high	L1L2 #high	
Δx	Δy	Δz	$\Delta x \sigma$	$\Delta y \sigma$	$\Delta z \sigma$	soln status
rtk status	posn type	stn ID	*xx	[CR][LF]		

Field #	Field type	Data Description	Example
1	\$BSLA	Log header	\$BSLA
2	week	GPS week number	872
3	seconds	GPS time into the week (in seconds)	174962.00
4	#sv	Number of matched satellites; may differ from the number in view.	8
5	#high	Number of matched satellites above RTK mask angle; observations from satellites below mask are heavily de-weighted.	7
6	L1L2 # high	Number of matched satellites above RTK mask angle with both L1 and L2 available	7
7	Δx	ECEF X baseline component (remote stn. - reference stn.); in meters	-1.346
8	Δy	ECEF Y baseline component (remote stn. - reference stn.); in meters	-3.114
9	Δz	ECEF Z baseline component (remote stn. - reference stn.); in meters	-2.517
10	$\Delta x \sigma$	Standard deviation of Δx solution element; in meters	0.005
11	$\Delta y \sigma$	Standard deviation of Δy solution element; in meters	0.004
12	$\Delta z \sigma$	Standard deviation of Δz solution element; in meters	0.005
13	soln status	Solution status (see <i>Table D-1</i>)	0
14	rtk status	RTK status (see <i>Tables D-3, D-4</i>)	0
15	posn type	Position type (see <i>Table D-2</i>)	4
16	stn ID	Reference station identification (RTCM: 0 - 1023, or RTCA: 266305 - 15179385)	119
17	*xx	Checksum	*36
18	[CR][LF]	Sentence terminator	[CR][LF]

Example:

```
$BSLA,872,174962.00,8,7,7,-1.346,-3.114,
-2.517,0.005,0.004,0.005,0,0,4,119*36[CR][LF]
```

BSLB

Format:

Message ID = 59

Message byte count = 100

Field #	Data	Bytes	Format	Units	Offset
1 (header)	Sync	3	char		0
	Checksum	1	char		3
	Message ID	4	integer		4
	Message byte count	4	integer		8
2	Week number	4	integer	weeks	12
3	GPS time into the week	8	double	seconds	16
4	Number of matched satellites (00-12)	4	integer		24
5	Number of matched satellites above RTK mask angle	4	integer		28
6	Number of matched satellites above RTK mask angle with both L1 and L2 available	4	integer		32
7	ECEF X baseline	8	double	meters	36
8	ECEF Y baseline	8	double	meters	44
9	ECEF Z baseline	8	double	meters	52
10	Standard deviation of X baseline	8	double	meters	60
11	Standard deviation of Y baseline	8	double	meters	68
12	Standard deviation of Z baseline	8	double	meters	76
13	Solution status (see <i>Table D-1</i>)	4	integer		84
14	RTK status (see <i>Tables D-3, D-4</i>)	4	integer		88
15	Position type (see <i>Table D-2</i>)	4	integer		92
16	Reference station identification (RTCM: 0 - 1023, or RTCA: 266305 - 15179385)	4	integer		96

Table D-1 GPSCard Solution Status

Value	Description
0	Solution computed
1	Insufficient observations
2	No convergence
3	Singular $A^T P A$ Matrix
4	Covariance trace exceeds maximum (trace > 1000 m)
5	Test distance exceeded (maximum of 3 rejections if distance > 10 km)
6	Not yet converged from cold start
7	Height or velocity limit exceeded. (In accordance with COCOM export licensing restrictions)

Higher numbers are reserved for future use

Table D-2 Position Type

Type	Definition
0	No position
1	Single point position
2	Differential pseudorange position
3	RT-20 position
4	RT-2 position
5	WAAS position solution

Higher numbers are reserved for future use

Table D-3 RTK Status for Position Type 3 (RT-20)

Status	Definition
0	Floating ambiguity solution (converged)
1	Floating ambiguity solution (not yet converged)
2	Modeling reference phase
3	Insufficient observations
4	Variance exceeds limit
5	Residuals too big
6	Delta position too big
7	Negative variance
8	RTK position not computed

Higher numbers are reserved for future use

Table D-4 RTK Status for Position Type 4 (RT-2)

Status	Definition
0	Narrow lane solution
1	Wide lane derived solution
2	Floating ambiguity solution (converged)
3	Floating ambiguity solution (not yet converged)
4	Modeling reference phase
5	Insufficient observations
6	Variance exceeds limit
7	Residuals too big
8	Delta position too big
9	Negative variance
10	RTK position not computed
11	Narrow lane solution - high standard deviation ^a
12	Widelane solution - high standard deviation ^b

c

- a. > 30 cm 3-D standard deviation
- b. > 50 cm 3-D standard deviation
- c. Higher numbers are reserved for future use



CDSA/B Communication and Differential Decode Status

The GPSCard maintains a running count of a variety of status indicators of the data link. This log outputs a report of those indicators.

Parity and framing errors will occur if poor transmission lines are encountered or if there is an incompatibility in the data protocol. If errors occur, you may need to confirm the bit rate, number of data bits, number of stop bits and parity of both the transmit and receiving ends. Overrun errors will occur if more characters are sent to the UART than can be removed by the on-board microprocessor.

CDSA

Structure

\$cdsa	week	seconds	xon1	cts1	parity1	overrun1	framing1		
rx1	tx1	xon2	cts2	parity2	overrun2	framing2	rx2	tx2	
rtca crc	rtcaa fail	rtca good	rtcm par	rtcma fail	rtcm good	dcsa fail	dsca good		
dcsb fail	dcsb good	cmr fail	cmr good	res'd	*xx	[CR][LF]			

Field #	Field type	Data Description	Example
1	\$CDSA	Log header	\$CDSA
2	week	GPS week number	787
3	seconds	GPS seconds into the week	500227
4	xon1	Flag to indicate that the com1 is using XON/XOFF handshaking protocol and port has received an xoff and will wait for an xon before sending any more data.	0
5	cts1	Flag to indicate that com1 is using CTS/RTS handshake protocol and cts line port has been asserted. The port will wait for the line to de-assert before sending any more data.	0
6	parity1	The number of character parity errors from the UART of COM1	0
7	overrun1	The number of UART buffer overrun errors of COM1	0
8	framing1	The number of character framing errors from the UART of COM1	0
9	rx1	The number of the characters received from COM1	0
10	tx1	The number of the characters sent out to COM1	9
11	xon2	Flag to indicate that COM2 is using XON/XOFF handshaking protocol and port has received an xoff and will wait for an xon before sending any more data.	0
12	cts2	Flag to indicate that COM2 is using CTS/RTS handshake protocol and cts line port has been asserted. The Port will wait for the line to de-assert before sending any more data.	0
13	parity2	The number of character parity errors from the UART of COM2	0
14	overrun2	The number of UART buffer overrun errors of COM2	0
15	framing2	The number of character framing errors from the UART of COM2	0
16	rx2	The number of characters received from COM2	0
17	tx2	The number of characters sent out to COM2	9
18	rtcacrc	The number of RTCA CRC failures	0
19	rtcaafail	The number of invalid ASCII \$RTCA,.....,*xx records indicating that the ASCII checksum "xx" failed.	0
20	rtcagood	The number of RTCA records that pass error checking	0
21	rtcmpar	The number of 30 bit RTCM parity failures	0
22	rtcmafail	The number of invalid ASCII \$RTCM,.....,*xx records indicating that the ASCII checksum "xx" failed.	0
23	rtcmgood	The number of RTCM records that pass error checking	0
24	dcsafail	DCSA is now obsolete.	0

Field #	Field type	Data Description	Example
25	dcsagood	DCSA is now obsolete.	0
26	dcsbfail	DCSB is now obsolete.	0
27	dcsbgood	DCSB is now obsolete.	0
28	cmrfail	The number of CMR messages which have failed error checking	0
29	cmrgood	The number of good CMR messages received	0
30	res'd	Reserved for future use	0
31	*xx	Checksum	*33
32	[CR][LF]	Sentence terminator	[CR][LF]

Example:

\$CDSA,787,500227,0,0,0,0,0,0,9,0,0,0,0,0,0,9,0,0,0,0,0,0,0,0,0,0,0,0*33[CR][LF]

CDSB

Format: Message ID = 39 Message byte count = 128

Field #	Data	Bytes	Format	Units	Offset
1 (header)	Sync	3	char		0
	Checksum	1	char		3
	Message ID	4	integer		4
	Message byte count	4	integer		8
2	Week number	4	integer	weeks	12
3	Time of week	4	integer	seconds	16
4	Xon COM1	4	integer		20
5	CTS COM1	4	integer		24
6	Parity errors COM1	4	integer		28
7	Overrun errors COM1	4	integer		32
8	Framing error COM1	4	integer		36
9	Bytes received in COM1	4	integer		40
10	Bytes sent out COM1	4	integer		44
11	Xon COM2	4	integer		48
12	CTS COM2	4	integer		52
13	Parity errors COM2	4	integer		56
14	Overrun errors COM2	4	integer		60
15	Framing error COM2	4	integer		64
16	Bytes received in COM2	4	integer		68
17	Bytes sent out COM2	4	integer		72
18	RTCA CRC fails	4	integer		76
19	RTCAA checksum fails	4	integer		80
20	RTCA records passed	4	integer		84
21	RTCM parity fails	4	integer		88
22	RTCMA checksum fails	4	integer		92
23	RTCM records passed	4	integer		96
24	DCSA checksum	4	integer		100
25	DCSA records passed	4	integer		104
26	DCSB checksum fails	4	integer		108
27	DCSB records passed	4	integer		112
28	Reserved	4	integer		116
29	Reserved	4	integer		120
30	Reserved	4	integer		124

CLKA/B Receiver Clock Offset Data

This record is used to monitor the state of the receiver time. Its value will depend on the CLOCKADJUST command. If CLOCKADJUST is enabled, then the offset and drift times will approach zero. If not enabled, then the offset will grow at the oscillator drift rate. Disabling CLOCKADJUST and monitoring the CLKA/B log will allow you to determine the error in your GPSCard receiver reference oscillator as compared to the GPS satellite reference.

All logs report GPS time not corrected for local receiver clock error. To derive the closest GPS time one must subtract the clock offset shown in the CLKA log (field 4) from GPS time reported.

The internal units of the new clock model's three states (offset, drift and GM state) are meters, meters per second, and meters. When scaled to time units for the output log, these become seconds, seconds per second, and seconds, respectively. Note that the old units of the third clock state (drift rate) are seconds per second per second.

CLKA

Structure:

\$CLKA	week	seconds	offset	drift	SA G-M state	offset std
drift std	cm status	*xx	[CR][LF]			

Field #	Field type	Data Description	Example
1	\$CLKA	Log header	\$CLKA
2	week	GPS week number	637
3	seconds	GPS seconds into the week	511323.00
4	offset	Receiver clock offset, in seconds. A positive offset implies that the receiver clock is ahead of GPS Time. To derive GPS time, use the following formula: $GPS\ time = receiver\ time - (offset)$	-4.628358547E-003
5	drift	Receiver clock drift, in seconds per second. A positive drift implies that the receiver clock is running faster than GPS Time.	-2.239751396E-007
6	SA G-M state	This field contains the output value of the Gauss-Markov Selective Availability clock dither estimator, in units of seconds. The value reflects both the collective SA-induced short-term drift of the satellite clocks as well as any range bias discontinuities that would normally affect the clock model's offset and drift states.	2.061788299E-006
7	offset std	Standard deviation of receiver clock offset, in seconds	5.369997167E-008
8	drift std	Standard deviation of receiver drift, in seconds per second	4.449097711E-009
9	cm status	Receiver Clock Model Status where 0 is valid and values from -20 to -1 imply that the model is in the process of stabilization	0
10	*xx	Checksum	*7F
11	[CR][LF]	Sentence terminator	[CR][LF]

Example

```
$CLKA, 841, 499296.00, 9.521895494E-008, -2.69065747E-008, 2.061788299E-006,
9.642598169E-008, 8.685638908E-010, 0*4F
```

CLKB

Format: Message ID = 02 Message byte count = 68

Field #	Field Type	Bytes	Format	Units	Offset
1 (header)	Sync	3	char		0
	Checksum	1	char		3
	Message ID	4	integer		4
	Message byte count	4	integer		8
2	Week number	4	integer	weeks	12
3	Seconds of week	8	double	seconds	16
4	Clock offset	8	double	seconds	24
5	Clock drift	8	double	seconds per second	32
6	SA Gauss-Markov state	8	double	seconds	40
7	StdDev clock offset	8	double	seconds	48
8	StdDev clock drift	8	double	seconds per second	56
9	Clock model status	4	integer		64

CLMA/B Receiver Clock Model

The CLMA and CLMB logs contain the current clock-model matrices of the GPSCard. These logs can be both generated and received by a GPSCard.

NOTE: Only advanced users should seek to alter the clock model parameters of a GPSCard.

Throughout the following, these symbols are used:

B = range bias (m)

BR = range bias rate (m/s)

SAB = Gauss-Markov process representing range bias error due to SA clock dither (m)

For further information, please refer to the documentation given for the clka/b log.

The standard clock model now used is as follows:

clock parameters array = [B BR SAB]

covariance matrix =

$$\begin{bmatrix} \sigma_B^2 & \sigma_B \sigma_{BR} & \sigma_B \sigma_{SAB} \\ \sigma_{BR} \sigma_B & \sigma_{BR}^2 & \sigma_{BR} \sigma_{SAB} \\ \sigma_{SAB} \sigma_B & \sigma_{SAB} \sigma_{BR} & \sigma_{SAB}^2 \end{bmatrix}$$

CLMA

Structure:

\$CLMA	week	seconds	status	reject	noise time	update
parameters		covariance	clock bias	constellation change		*xx [CR][LF]

Field #	Field type	Data Description	Example
1	\$CLMA	Log header	\$CLMA
2	week	GPS week number	1010
3	seconds	GPS seconds into the week	142281.00
4	status	Status of clock model (0 = good; -1 to -20 = bad)	0
5	reject	Number of rejected range bias measurements (max. = 5)	0
6	noise time	GPS time of last estimate (seconds) - since Jan. 3, 1980 -	6.109902810E+008
7	update	GPS time of last update (seconds) - since Jan. 3, 1980 -	6.109902810E+008
8 - 10	parameters	Parameters array (1 x 3 = 3 elements)	3.004851569E+000,-7.09478374E-002,1.072025038E-001
11 - 19	covariance	Covariance matrix (3x3 = 9 elements), listed left-to-right by rows	9.018176231E+002,6.665159580E+000, -8.93243326E+002,6.665159580E+000,6.071800102E-001, -6.28582548E+000,-8.93243326E+002, -6.28582548E+000,8.939683016E+002
20	clock bias	last instantaneous clock bias	3.173387141E+000
21	constellation change	indicates constellation change occurred	0
22	*xx	Checksum	*70
23	[CR][LF]	Sentence terminator	[CR][LF]

Example:

```
$CLMA,1010,142281.00,0,0,6.109902810E+008,6.109902810E+008,3.0048
51569E+000,-7.09478374E-002,1.072025038E-
001,9.018176231E+002,6.665159580E+000,-
8.93243326E+002,6.665159580E+000,6.071800102E-001,-
6.28582548E+000,-8.93243326E+002,-
6.28582548E+000,8.939683016E+002,3.173387141E+000,0*70[CR][LF]
```

CLMB

Format: Message ID = 51 Message byte count = 156

Field #	Field Type	Bytes	Format	Units	Offset
1 (header)	Sync	3	char		0
	Checksum	1	char		3
	Message ID	4	integer		4
	Message byte count	4	integer	bytes	8
2	week number	4	integer	weeks	12
3	seconds of week	8	double	seconds	16
4	Status of clock model (figure of quality)	4	integer	0 = good; -1 to -20 = bad	24
5	Number of rejected observations	4	integer	observations	28
6	GPS time of last estimate	8	double	seconds	32
7	GPS time of last update	8	double	seconds	40
8 - 10	Parameters array (1x3 = 3 elements)	3 x 8	double	[m m/s m]	48
11 - 19	Covariance matrix (3x3 = 9 elements), listed left-to-right by rows	9 x 8	double	[m ² m ² /s m ² m ² /s m ² /s ² m ² /s m ² m ² /s m ²]	72
20	last instantaneous clock bias	8	double	seconds	144
21	boolean flag indicating a constellation change occurred	4	integer	0 = no change, 1 = change	152

CMR Standard Logs

The Compact Measurement Record (CMR) Format, a standard communications protocol used in Real-Time Kinematic (RTK) systems to transfer GPS carrier phase and code observations from a reference station to one or more rover stations.

See *Chapter 4* for more information on CMR standard logs.

COM1A/B and COM2A/B Pass-Through Logs

There are two pass-through logs **COM1A/B** and **COM2A/B**, available on MiLLennium GPSCards.

The pass-through logging feature enables the GPSCard to redirect any ASCII or binary data that is input at a specified port (COM1 or COM2) to any specified GPSCard port (COM1 or COM2). This capability, in conjunction with the SEND command, can allow the GPSCard to perform bi-directional communications with other devices such as a modem, terminal, or another GPSCard.

Please see *Chapter 3* for more information.

DOPA/B Dilution of Precision

The dilution of precision data is calculated using the geometry of only those satellites that are currently being tracked and used in the position solution by the GPSCard and updated once every 60 seconds or whenever a change in the constellation occurs. Therefore, the total number of data fields output by the log is variable, depending on the number of SVs tracking. Twelve is the maximum number of SV PRNs contained in the list.

NOTE: If a satellite is locked out using the LOCKOUT command, it will still be shown in the PRN list, but is significantly deweighted in the DOP calculation.

DOPA

Structure:

```
$DOPA  week  seconds  gdop  pdop  htdop  hdop  tdop  # sats
prn list  *xx  [CR][LF]
```

Field #	Field type	Data Description	Example
1	\$DOPA	Log header	\$DOPA
2	week	GPS week number	637
3	seconds	GPS seconds into the week	512473.00
4	gdop	Geometric dilution of precision - assumes 3-D position and receiver clock offset (all 4 parameters) are unknown	2.9644
5	pdop	Position dilution of precision - assumes 3-D position is unknown and receiver clock offset is known	2.5639
6	htdop	Horizontal position and time dilution of precision.	2.0200
7	hdop	Horizontal dilution of precision.	1.3662
8	tdop	Time dilution of precision - assumes 3-D position is known and only receiver clock offset is unknown	1.4880
9	# sats	Number of satellites used in position solution (0-12)	6
10...	prn list	PRN list of SV PRNs tracking (1-32), null field until first position solution available	18,6,11,2,16,19
variable	*xx	Checksum	*29
variable	[CR][LF]	Sentence terminator	[CR][LF]

Example:

```
$DOPA,637,512473.00,2.9644,2.5639,2.0200,1.3662,1.4880,6,18,6,11,2,16,19
*29[CR][LF]
```

DOPB

Format: Message ID = 07 Message byte count = 68+(sats*4)

Field #	Data	Bytes	Format	Units	Offset
1 (header)	Sync	3	char		0
	Checksum	1	char		3
	Message ID	4	integer		4
	Message byte count	4	integer		8
2	Week number	4	integer	weeks	12
3	Seconds of week	8	double	seconds	16
4	gdop	8	double		24
5	pdop	8	double		32
6	hdop	8	double		40
7	hdop	8	double		48
8	tdop	8	double		56
9	Number of satellites used	4	integer		64
10	1st PRN	4	integer		68
11...	Next satellite PRN Offset = 68 + (sats*4) where sats = 0 to (number of sats-1)				

ETSA/B Extended Tracking Status

These logs provide channel tracking status information for each of the GPSCard parallel channels.

NOTE: This log is intended for status display only; since some of the data elements are not synchronized together, they are not to be used for measurement data. Please use the RGEA/B/D, SATA/B, and SVDA/B logs to obtain synchronized data for post processing analysis.

If both the L1 and L2 signals are being tracked for a given PRN, two entries with the same PRN will appear in the tracking status logs. As shown in *Table D-7 Channel Tracking Status on Page 203*, these entries can be differentiated by bit 19, which is set if there are multiple observables for a given PRN, and bit 20, which denotes whether the observation is for L1 or L2. This is to aid in parsing the data.

ETSA

Structure:

```

$ETSA  week  seconds  sol status  # chans
prn  ch-tr-status  dopp  C/No  residual  locktime  psr  reject code
:
prn  ch-tr-status  dopp  C/No  residual  locktime  psr  reject code
*xx  [CR][LF]

```

Field #	Field type	Data Description	Example
1	\$ETSA	Log header	\$ETSA
2	week	GPS week number	850
3	seconds	GPS seconds into the week (receiver time, not corrected for clock error, CLOCKADJUST enabled)	332087.00
4	sol status	Solution status (see <i>Table D-1, Page 144</i>)	0
5	# chans	Number of hardware channels with information to follow	24
6	prn	Satellite PRN number (1-32) (channel 0)	7
7	ch-tr-status	Hexadecimal number indicating channel tracking status (See <i>Table D-7, Page 203</i>)	00082E04
8	dopp	Instantaneous carrier Doppler frequency (Hz)	-613.5
9	C/No	Carrier to noise density ratio (dB-Hz)	54.682
10	residual	Residual from position filter (m)	27.617
11	locktime	Number of seconds of continuous tracking (no cycle slips)	12301.4
12	psr	Pseudorange measurement (m)	20257359.5 7
13	reject code	Indicates whether the range is valid (code = 0) or not (see <i>Table D-11, Page 215</i>)	0
14-21	..	Next PRN #,ch-tr-status,dopp,C/No,residual,locktime,psr,reject code	
..	
94-101	..	Last PRN #,ch-tr-status,dopp,C/No,residual,locktime,psr,reject code	
102	*xx	Checksum	*19
103	[CR][LF]	Sentence terminator	[CR][LF]

Example (carriage returns have been added between observations for clarity):

```

$ETSA,850,332087.00,0,24,
7,00082E04,-613.5,54.682,27.617,12301.4,20257359.57,0,
7,00582E0B,-478.1,46.388,0.000,11892.0,20257351.96,13,
5,00082E14,3311.2,35.915,1.037,1224.4,24412632.47,0,
5,00582E1B,2580.4,39.563,0.000,1186.7,24412629.40,13,
9,00082E24,1183.1,53.294,-29.857,7283.8,21498303.67,0,
9,00582E2B,921.9,44.422,0.000,7250.2,21498297.13,13,
2,00082E34,-2405.2,50.824,-20.985,19223.6,22047005.47,0,
2,00582E3B,-1874.1,41.918,0.000,19186.7,22046999.44,13,
4,00082E44,3302.8,47.287,7.522,3648.1,22696783.36,0,
4,00582E4B,2573.6,37.341,0.000,3191.2,22696778.15,13,
14,00082E54,2132.7,41.786,-22.388,541.3,25117182.07,0,
14,00582E5B,1661.7,33.903,0.000,500.7,25117179.63,13,
26,00082E64,-3004.3,43.223,2.928,14536.2,25074382.19,0,
26,00582E6B,-2340.9,33.019,0.000,14491.7,25074378.01,13,
15,00082E74,-3037.7,43.669,0.508,12011.5,24104788.88,0,
15,00582E7B,-2367.0,34.765,0.000,11842.4,24104781.53,13,
24,00082E84,3814.0,37.081,7.511,95.7,25360032.49,0,
24,00582E8B,2972.0,24.148,0.000,5.2,25360030.13,13,
28,00082A90,-9800.9,0.000,0.000,0.0,0.00,9,
28,00382A90,-7637.0,0.000,0.000,0.0,0.00,9,
3,000822A0,-3328.3,0.000,0.000,0.0,0.00,9,
3,005828A0,-2593.5,0.000,0.000,0.0,0.00,9,
27,000822B0,-3851.7,0.000,0.000,0.0,0.00,9,
27,005828B0,-3001.7,0.000,0.000,0.0,0.00,9,*41[CR][LF]

```

ETSB

Format: Message ID = 48 Message byte count = 32 + ($n \times 52$) where n is number of observations

Field #	Data	Bytes	Format	Units	Offset
1 (header)	Sync	3	char		0
	Checksum	1	char		3
	Message ID	4	integer		4
	Message byte count	4	integer		8
2	Week number	4	integer	weeks	12
3	Time of week	8	double	seconds	16
4	Solution status (see <i>Table D-1</i> , Page 144)	4	integer		24
5	Number of observations	4	integer		28
6	PRN number (first observation)	4	integer		32
7	Channel tracking status (See <i>Table D-7</i> , Page 203)	4	integer		36
8	Doppler	8	double	Hz	40
9	C/N ₀	8	double	dB-Hz	48
10	Residual	8	double	meters	56
11	Locktime	8	double	seconds	64
12	Pseudorange	8	double	meters	72
13	Rejection code (see <i>Table D-11</i> , Page 215)	4	integer		80
14 ...	Offset = 32 + (#obs x 52) where #obs varies from 0 - 23				

FRMA/B Framed Raw Navigation Data

This message contains the raw framed navigation data. An individual message is sent for each PRN being tracked. The message is updated with each new frame, therefore it is best to log the data with the 'onnew' trigger activated.

FRMA

Structure:

\$FRMA	week	seconds	prn	cstatus	# of bits	framed raw data
*xx	[CR][LF]					

Field #	Field type	Data Description	Example
1	\$FRMA	Log header	\$FRMA
2	week	GPS week number	845
3	seconds	GPS seconds into the week	238623.412
4	prn	PRN of satellite from which data originated	120
5	cstatus	Channel Tracking Status (see <i>Table D-7, Page 203</i>)	80811F14
6	# of bits	Number of bits transmitted in the message. 250 for WAAS, 300 for GPS and 85 for GLONASS.	250
7	framed raw data	One field of raw framed navigation data.	9AFE5354656C2053796E636 8726F6E69636974792020202 020202020B0029E40*3F
8	*xx	Checksum	*42
9	[CR][LF]	Sentence terminator	[CR][LF]

FRMB

Format: Message ID = 54 Message byte count = variable

Field #	Data	Bytes	Format	Units	Offset
1 (header)	Sync	3	char		0
	Checksum	1	char		3
	Message ID	4	integer		4
	Message byte count	4	integer	bytes	8
2	Week number	4	integer	weeks	12
3	Seconds of week	8	double	seconds	16
4	PRN number	4	integer	1-999	24
5	Channel Tracking Status (see <i>Table D-7, Page 203</i>)	4	integer	n/a	28
6	Number of Bits	4	integer	250 for WAAS 300 for GPS 85 for GLONASS	32
7	Data Sub-frame	variable	char	N/A	36

GGAB Global Position System Fix Data (Binary Format Only)

Time, position and fix-related data of the GPS receiver. This binary log is a replica of the NMEA GPGGA ASCII log expressed in binary format with NovAtel header added.

Format: Message ID = 27 Message byte count = 80

Field #	Data	Bytes	Format	Units	Offset
1 (header)	Sync	3	char		0
	Checksum	1	char		3
	Message ID	4	integer		4
	Message byte count	4	integer		8
2	UTC time of position	8	double	hhmmss.ss	12
3	Latitude (DDmm.mm) (+ is North, - is South)	8	double	degrees	20
4	Longitude (DDDmm.mm) (+ is East, - is West)	8	double	degrees	28
5	Fix status 0 = fix not available or invalid 1 = GPS fix 2 = Differential GPS fix 4 = RTK fixed ambiguity solution 5 = RTK floating ambiguity solution 9 = WAAS ²	4	integer		36
6	Number of satellites in use. May be different to the number in view	4	integer		40
7	Horizontal dilution of precision	8	double		44
8	Antenna altitude above/below mean-sea-level (geoid)	8	double	meters	52
9	Geoidal separation (see <i>Figure C-6, Page 132</i>)	8	double	meters	60
10	Age of Differential GPS data ¹	8	double	seconds	68
11	Differential reference station ID, 0000-1023	4	integer		76

- Note:
- 1 The maximum age reported here is limited to 99 seconds.
 - 2 An indicator of 9 has been temporarily set for WAAS. Then NMEA standard for WAAS has not been decided yet.

GPALM Almanac Data

This log outputs raw almanac data for each satellite PRN contained in the broadcast message. A separate record is logged for each PRN, up to a maximum of 32 records. Following a GPSCard reboot, no records will be output until new broadcast message data is received from a satellite. It takes a minimum of 12.5 minutes to collect a complete almanac following GPSCard boot-up. (The almanac reported here has no relationship to the NovAtel \$ALMA almanac injection command. Following a cold start, the log will output null fields until a new almanac is collected from a satellite.)

Structure:

\$GPALM	# msg	msg #	PRN	GPS wk	SV hlth	ecc
alm ref time	incl angle	omegadot	rt axis			
omega	long asc node	M ₀	af1	*xx	[CR][LF]	

Field	Structure	Field Description	Symbol	Example	
1	\$GPALM	Log header		\$GPALM	
2	# msg	Total number of messages logged	x.x	17	
3	msg #	Current message number	x.x	17	
4	PRN	Satellite PRN number, 01 to 32	xx	28	
5	GPS wk	GPS reference week number	1	x.x	653
6	SV hlth	SV health, bits 17-24 of each almanac page	2	hh	00
7	ecc	e, eccentricity	3	hhh	3EAF
8	alm ref time	toa, almanac reference time	3	hh	87
9	incl angle	(sigma) _i , inclination angle	3	hhh	OD68
10	omegadot	OMEGADOT, rate of right ascension	3	hhh	FD30
11	rt axis	(A) ^{1/2} , root of semi-major axis	3	hhhhh	A10CAB
12	omega	omega, argument of perigee	3	hhhhh	6EE732
13	long asc node	(OMEGA) ⁰ , longitude of ascension node	3	hhhhh	525880
14	M ₀	M ₀ , mean anomaly	3	hhhhh	6DC5A8
15	af0	af0, clock parameter	3	hhh	009
16	af1	af1, clock parameter	3	hhh	005
17	*xx	Checksum	*hh	*37	
18	[CR][LF]	Sentence terminator		[CR][LF]	

Example:

```
$GPALM,17,17,28,653,00,3EAF,87,0D68,FD30,A10CAB,6EE732,525880,6DC5A8,009,005*37[CR][LF]
```

- 1 Variable length integer, 4-digits maximum from (2) most significant binary bits of Subframe 1, Word 3 reference Table 20-I, ICD-GPS-200, Rev. B, and (8) least significant bits from subframe 5, page 25, word 3 reference Table 20-I, ICD-GPS-200, Rev. B, paragraph 20.3.3.5.1.7
- 2 Reference paragraph 20.3.3.5.1.3, Table 20-VII and Table 20-VIII, ICD-GPS-200, Rev. B
- 3 Reference Table 20-VI, ICD-GPS-200, Rev. B for scaling factors and units.

To obtain copies of ICD-GPS- 200, see *Appendix F, Standards and References, Page 239*, for address information.

GPGGA Global Position System Fix Data

Time, position and fix-related data of the GPS receiver. The information contained in this log is also available in the NovAtel GGAB log in binary format. This log will output all null data fields until the GPSCard has set fine time as monitored by the receiver status word, see *Table D-5 Receiver Self-Test Status Codes on Page 198, bits 8,9 and 10.*)

Structure:

\$GPGGA	utc	lat	lat dir	lon	lon dir	GPS qual	# sats	hdop
alt	units	null	null	age	stn ID	*xx	[CR][LF]	

Field	Structure	Field Description	Symbol	Example
1	\$GPGGA	Log header		\$GPGGA
2	utc	UTC time of position (hours/minutes/seconds/ decimal seconds)	hhmmss.ss	220147.50
3	lat	Latitude (DDmm.mm)	III.II	5106.7194489
4	lat dir	Latitude direction (N = North, S = South)	a	N
5	lon	Longitude (DDDmm.mm)	yyyyy.yy	11402.3589020
6	lon dir	Longitude direction (E = East, W = West)	a	W
7	GPS qual	GPS Quality indicator 0 = fix not available or invalid 1 = GPS fix 2 = Differential GPS fix 4 = RTK fixed ambiguity solution 5 = RTK floating ambiguity solution 9 = WAAS ²	x	1
8	# sats	Number of satellites in use (00-12). May be different to the number in view	xx	08
9	hdop	Horizontal dilution of precision	x.x	0.9
10	alt	Antenna altitude above/below mean sea level (geoid)	x.x	1080.406
11	units	Units of antenna altitude (M = meters)	M	M
12	null	(This field not available on GPSCards)		..
13	null	(This field not available on GPSCards)		..
14	age	Age of Differential GPS data (in seconds) ¹	xx	..
15	stn ID	Differential reference station ID, 0000-1023	xxxx	..
16	*xx	Checksum	*hh	*48
17	[CR][LF]	Sentence terminator		[CR][LF]

1 The maximum age reported here is limited to 99 seconds.

2 An indicator of 9 has been temporarily set for WAAS. Then NMEA standard for WAAS has not been decided yet.

Example:

```
$GPGGA,220147.50,5106.7194489,N,11402.3589020,W,1,08,0.9,1080.406,M,,,,
*48[CR][LF]
```

GPGLL Geographic Position

Latitude and longitude of present vessel position, time of position fix, and status. This log will output all null data fields until the GPSCard has set fine time as monitored by the receiver status word, see *Table D-5 Receiver Self-Test Status Codes on Page 198, bits 8,9 and 10.*)

Structure:

```
$GPGLL lat lat dir lon lon dir utc data status *xx [CR][LF]
```

Field	Structure	Field Description	Symbol	Example
1	\$GPGLL	Log header		\$GPGLL
2	lat	Latitude (DDmm.mm)	lll.ll	5106.7198674
3	lat dir	Latitude direction (N = North, S = South)	a	N
4	lon	Longitude (DDDmm.mm)	yyyyy.yy	11402.3587526
5	lon dir	Longitude direction (E = East, W = West)	a	W
6	utc	UTC time of position (hours/minutes/seconds/decimal seconds)	hhmmss.ss	220152.50
7	data status	Data status: A = Data valid, V = Data invalid	A	A
8	*xx	Checksum	*hh	*1B
9	[CR][LF]	Sentence terminator		[CR][LF]

Example:

```
$GPGLL,5106.7198674,N,11402.3587526,W,220152.50,A*1B[CR][LF]
```

GPGRS GPS Range Residuals for Each Satellite

Range residuals can be computed in two ways, and this log reports those residuals. Under mode 0, residuals output in this log are used to update the position solution output in the GPGLA message. Under mode 1, the residuals are re-computed after the position solution in the GPGLA message is computed. The GPSCard computes range residuals in mode 1. An integrity process using GPGRS would also require GPGLA (for position fix data), GPGSA (for DOP figures), and GPGSV (for PRN numbers) for comparative purposes.

Structure:

\$GPGRS	utc	mode										
res	res	res	res	res	res	res	res	res	res	res	res	res
*xx	[CR][LF]											

Field	Structure	Field Description	Symbol	Example
1	\$GPGRS	Log header		\$GPGRS
2	utc	UTC time of position (hours/minutes/seconds/ decimal seconds)	hhmmss.ss	192911.0
3	mode	Mode 0 =residuals were used to calculate the position given in the matching GGA line (apriori) (not used by GPSCard) Mode 1 =residuals were recomputed after the GGA position was computed (preferred mode)	x	1
4 - 15	res	Range residuals for satellites used in the navigation solution. Order matches order of PRN numbers in GPGSA.	x.x,x.x,.....	-13.8,-1.9,11.4,-33.6,0.9,6.9,-12.6,0.3,0.6,-22.3,,
16	*xx	Checksum	*hh	*65
17	[CR][LF]	Sentence terminator		[CR][LF]

Example:

```
$GPGRS,192911.0,1,-13.8,-1.9,11.4,-33.6,0.9,6.9,-12.6,0.3,0.6,-22.3,,
*65[CR][LF]
```

NOTE: If the range residual exceeds ± 99.9 , then the decimal part will be dropped. Maximum value for this field is ± 999 . The sign of the range residual is determined by the order of parameters used in the calculation as follows:

$$\text{range residual} = \text{calculated range} - \text{measured range}$$

GPGSA GPS DOP and Active Satellites

GPS receiver operating mode, satellites used for navigation and DOP values.

Structure:

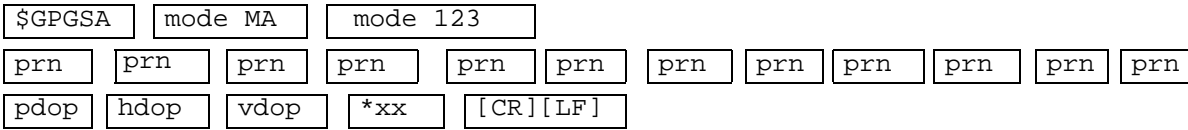

Field	Structure	Field Description	Symbol	Example
1	\$GPGSA	Log header		\$GPGSA
2	mode MA	A = Automatic 2D/3D (not used by GPSCard) M = Manual, forced to operate in 2D or 3D	M	M
3	mode 123	Mode: 1 = Fix not available; 2 = 2D; 3 = 3D	x	3
4 - 15	prn	PRN numbers of satellites used in solution (null for unused fields), total of 12 fields	xx,xx,.....	18,03,13,25,16,24,12,20,,,,
16	pdop	Position dilution of precision	x.x	1.5
17	hdop	Horizontal position and time dilution of precision	x.x	0.9
18	vdop	Vertical dilution of precision	x.x	1.2
19	*xx	Checksum	*hh	*3F
20	[CR][LF]	Sentence terminator		[CR][LF]

Example:

```
$GPGSA,M,3,18,03,13,25,16,24,12,20,,,,,1.5,0.9,1.2*3F[CR][LF]
```

GPGST Pseudorange Measurement Noise Statistics

Pseudorange measurement noise statistics are translated in the position domain in order to give statistical measures of the quality of the position solution.

Structure:

\$GPGST	utc	rms	smjr std	smnr std
orient	lat std	lon std	alt std	*xx [CR][LF]

Field	Structure	Field Description	Symbol	Example
1	\$GPGST	Log header		\$GPGST
2	utc	UTC time of position (hours/minutes/seconds/ decimal seconds)	hhmmss.ss	192911.0
3	rms	RMS value of the standard deviation of the range inputs to the navigation process. Range inputs include pseudoranges and DGPS corrections.	x.x	28.7
4	smjr std	Standard deviation of semi-major axis of error ellipse (meters)	x.x	21.6
5	smnr std	Standard deviation of semi-minor axis of error ellipse (meters)	x.x	12.0
6	orient	Orientation of semi-major axis of error ellipse (degrees from true north)	x.x	20.4
7	lat std	Standard deviation of latitude error (meters)	x.x	20.7
8	lon std	Standard deviation of longitude error (meters)	x.x	13.6
9	alt std	Standard deviation of altitude error (meters)	x.x	11.9
10	*xx	Checksum	*hh	*51
11	[CR][LF]	Sentence terminator		[CR][LF]

Example:

```
$GPGST,192911.0,28.7,21.6,12.0,20.4,20.7,13.6,11.9*51[CR][LF]
```

GPGSV GPS Satellites in View

Number of SVs in view, PRN numbers, elevation, azimuth and SNR value. Four satellites maximum per message. When required, additional satellite data sent in second or third message. Total number of messages being transmitted and the current message being transmitted are indicated in the first two fields.

NOTE 1: Satellite information may require the transmission of multiple messages. The first field specifies the total number of messages, minimum value 1. The second field identifies the order of this message (message number), minimum value 1.

NOTE 2: A variable number of 'PRN-Elevation-Azimuth-SNR' sets are allowed up to a maximum of four sets per message. Null fields are not required for unused sets when less than four sets are transmitted.

NOTE 3: GPGSV logs will not output until the GPSCard has set fine time as monitored by the receiver status word, see *Table D-5 Receiver Self-Test Status Codes on Page 198, bits 8,9 and 10.*

Structure:

```

$GPGSV # msg msg # # sats
prn elev azimuth SNR
:
prn elev azimuth SNR
*xx [CR][LF]

```

Field	Structure	Field Description	Symbol	Example
1	\$GPGSV	Log header		\$GPGSV
2	# msg	Total number of messages, 1 to 3	x	3
3	msg #	Message number, 1 to 3	x	1
4	# sats	Total number of satellites in view	xx	09
5	prn	Satellite PRN number	xx	03
6	elev	Elevation, degrees, 90; maximum	xx	51
7	azimuth	Azimuth, degrees True, 000 to 359	xxx	140
8	SNR	SNR (C/N ₀) 00-99 dB, null when not tracking	xx	42
...	...	Next satellite PRN number, elev, azimuth, SNR,		
...		
...	...	Last satellite PRN number, elev, azimuth, SNr,		
variable	*xx	Checksum	*hh	*72
variable	[CR][LF]	Sentence terminator		[CR][LF]

Example:

```

$GPGSV,3,1,09,03,51,140,42,16,02,056,40,17,78,080,42,21,25,234,00*72[CR][LF]
$GPGSV,3,2,09,22,19,260,00,23,59,226,00,26,45,084,39,27,07,017,39*78[CR][LF]
$GPGSV,3,3,09,28,29,311,44*42[CR][LF]

```

GPRMB Navigation Information

Navigation data from present position to a destination waypoint. The destination is set active by the GPSCard SETNAV command. If SETNAV has been set, a command to log either GPRMB or GPRMC will cause both logs to output data.

Structure:

\$GPRMB	data status	xtrack	dir	origin ID
dest ID	dest lat	lat dir	dest lon	lon dir
range	bearing	vel	arr status	*xx [CR][LF]

Field	Structure	Field Description	Symbol	Example
1	\$GPRMB	Log header		\$GPRMB
2	data status	Data status: A = data valid; V = navigation receiver warning	A	V
3	xtrack	Cross track error	1	x.x 0.011
4	dir	Direction to steer to get back on track (L/R)	2	a L
5	origin ID	Origin waypoint ID	3	c-c START
6	dest ID	Destination waypoint ID	3	c-c END
7	dest lat	Destination waypoint latitude (DDmm.mm)	3	lll.ll 5106.7074 000
8	lat dir	Latitude direction (N = North, S = South)	3	a N
9	dest lon	Destination waypoint longitude (DDDmm.mm)	3	yyyyy.yy 11402.349
10	lon dir	Longitude direction (E = East, W = West)	3	a E
11	range	Range to destination, nautical miles	4	x.x 0.0127611
12	bearing	Bearing to destination, degrees True	x.x	x.x 153.093
13	vel	Destination closing velocity, knots	x.x	x.x 0.3591502
14	arr status	Arrival status: A = perpendicular passed V = destination not reached or passed	A	V
15	*xx	Checksum	*hh	*13
16	[CR][LF]	Sentence terminator		[CR][LF]

Example:

```
$GPRMB,V,0.011,L,START,END,5106.7074000,N,11402.3490000,W,0.0127611,153093,
0.3591502,V*13[CR][LF]
```

- If cross track error exceeds 9.99 NM, display 9.99
- Represents track error from intended course
- one nautical mile = 1,852 meters
- Direction to steer is based on the sign of the crosstrack error,
i.e., L = xtrack error (+); R = xtrack error (-)
- Fields 5, 6, 7, 8, 9, and 10 are tagged from the GPSCard SETNAV command.
- If range to destination exceeds 999.9 NM, display 999.9

GPRMC GPS Specific Information

Time, date, position, track made good and speed data provided by the GPS navigation receiver. RMC and RMB are the recommended minimum navigation data to be provided by a GPS receiver. This log will output all null data fields until the GPSCard has set fine time as monitored by the receiver status word, see *Table D-5 Receiver Self-Test Status Codes on Page 198, bits 8,9 and 10.*)

Structure:

\$GPRMC	utc	pos status	lat	lat dir
lon	lon dir	speed Kn	track true	date
mag var	var dir	*xx	[CR][LF]	

Field	Structure	Field Description	Symbol	Example
1	\$GPRMC	Log header		\$GPRMC
2	utc	UTC of position	hhmmss.ss	220216.50
3	pos status	Position status: A = data valid V = data invalid	A	A
4	lat	Latitude (DDmm.mm)	lll.ll	5106.7187663
5	lat dir	Latitude direction (N = North, S = South)	a	N
6	lon	Longitude (DDDmm.mm)	yyyyy.yy	11402.3581636
7	lon dir	Longitude direction (E = East, W = West)	a	W
8	speed Kn	Speed over ground, knots	x.x	0.3886308
9	track true	Track made good, degrees True	x.x	130.632
10	date	Date: dd/mm/yy	xxxxxx	150792
11	mag var	Magnetic variation, degrees ²	x.x	0.000
12	var dir	Magnetic variation direction E/W ¹	a	E
13	*xx	Checksum	*hh	*4B
14	[CR][LF]	Sentence terminator		[CR][LF]

Example:

```
$GPRMC,220216.50,A,5106.7187663,N,11402.3581636,W,0.3886308,130.632,150792,0.000,E*4B[CR][LF]
```

- 1 Easterly variation (E) subtracts from True course
Westerly variation (W) adds to True course
- 2 Note that this field is the actual magnetic variation East or West and is the inverse sign of the value entered into the MAGVAR command. See MAGVAR in *Appendix C, Page 108* for more information.

GPVTG Track Made Good And Ground Speed

The track made good and speed relative to the ground.

Structure:

\$GPVTG	track true	T	track mag	M	speed Km
N	speed km	K	*xx	[CR][LF]	

Field	Structure	Field Description	Symbol	Example
1	\$GPVTG	Log header		\$GPVTG
2	track true	Track made good, degrees True	x.x	24.168
3	T	True track indicator	T	T
4	track mag	Track made good, degrees Magnetic; Track mag = Track true + (MAGVAR correction) See the <i>MAGVAR</i> command, <i>Page 108</i> .	x.x	24.168
5	M	Magnetic track indicator	M	M
6	speed Kn	Speed over ground, knots	x.x	0.4220347
7	N	Nautical speed indicator (N = Knots)	N	N
8	speed Km	Speed, kilometers/hour	x.x	0.781608
9	K	Speed indicator (K = km/hr)	K	K
10	*xx	Checksum	*hh	*7A
11	[CR][LF]	Sentence terminator		[CR][LF]

Example:

```
$GPVTG,24.168,T,24.168,M,0.4220347,N,0.781608,K*7A[CR][LF]
```

GPZDA UTC Time and Date

This log will output all null data fields until the GPSCard has set fine time as monitored by the receiver status word, see *Table D-5 Receiver Self-Test Status Codes on Page 198, bits 8,9 and 10.*)

Structure:

\$GPZDA	utc	day	month	year
NULL	NULL	*xx	[CR][LF]	

Field	Structure	Field Description	Symbol	Example
1	\$GPZDA	Log header		\$GPZDA
2	utc	UTC time	hhmmss.ss	220238.00
3	day	Day, 01 to 31	xx	15
4	month	Month, 01 to 12	xx	07
5	year	Year	xxxx	1992
6	null	Local zone description - not available	xx	,,
7	null	Local zone minutes description - not available ¹	xx	,,
8	*xx	Checksum	*hh	*6F
9	[CR][LF]	Sentence terminator		[CR][LF]

Example:

```
$GPZDA,220238.00,15,07,1992,00,00*6F[CR][LF]
```

¹ Local time zones are not supported by the GPSCard. Fields 6 and 7 will always be null.

GPZTG UTC & Time to Destination Waypoint

This log reports time to destination waypoint. Waypoint is set using the GPSCard SETNAV command. If destination waypoint has not been set with SETNAV, time-to-go and destination waypoint ID will be null. This log will output all null data fields until the GPSCard has set fine time as monitored by the receiver status word, see *Table D-5 Receiver Self-Test Status Codes on Page 198, bits 8,9 and 10.*)

Structure:

```
$GPZTG  utc  time  dest ID  *xx  [CR][LF]
```

Field	Structure	Field Description	Symbol	Example
1	\$GPZTG	Log header		\$GPZTG
2	utc	UTC of position	hhmmss.ss	220245.00
3	time	Time to go (995959.00 maximum reported)	hhmmss.ss	994639.00
4	dest ID	Destination waypoint ID	c--c	END
5	*xx	Checksum	*hh	*36
6	[CR][LF]	Sentence terminator		[CR][LF]

Example:

```
$GPZTG,220245.00,994639.00,END*36[CR][LF]
```

MKPA/B Mark Position

This log contains the estimated position of the antenna at detected mark impulse. It uses the last valid position and velocities to extrapolate the position at time of mark. Refer to the *GPSCard Installation and Operating Manual Appendix* for Mark Input pulse specifications. The latched time of mark impulse is in GPS weeks and seconds into the week. The resolution of the latched time is 49 ns.

MKPA

Structure:

\$MKPA	week	seconds	lat	lon	hgt	undulation	datum ID
lat std	lon std	hgt std	sol status	*xx	[CR][LF]		

Field #	Field type	Data Description	Example
1	\$MKPA	Log header	\$MKPA
2	week	GPS week number	653
3	seconds	GPS seconds into the week measured from the receiver clock, coincident with the time of electrical closure on the Mark Input port.	338214.773382376
4	lat	Latitude of position in current datum, in degrees/decimal degrees (DD.dddddd), where a negative sign implies South latitude	51.11227014
5	lon	Longitude of position in current datum, in degrees/decimal degrees (DDD.dddddd), where a negative sign implies West longitude	-114.03907552
6	hgt	Height of position in current datum, in meters with respect to MSL	1003.799
7	undulation	Geoid undulation, in meters (see <i>Figure C-6, Page 132</i>)	-16.199
8	datum ID	Current datum (see <i>Table G-2 in Appendix G, Page 240</i>) I.D. #	61
9	lat std	Standard deviation of latitude solution element, in meters	7.793
10	lon std	Standard deviation of longitude solution element, in meters	3.223
11	hgt std	Standard deviation of height solution element, in meters	34.509
12	sol status	Solution status as listed in <i>Table D-1</i>	0
13	*xx	Checksum	*3C
14	[CR][LF]	Sentence terminator	[CR][LF]

Example:

```
$MKPA,653,338214.773382376,51.11227014,-114.03907552,1003.799,-16.199,61,7.793,3.223,34.509,0*3C[CR][LF]
```

MKPB

Format: Message ID = 05 Message byte count = 88

Field #	Data	Bytes	Format	Units	Offset
1 (header)	Sync	3	char		0
	Checksum	1	char		3
	Message ID	4	integer		4
	Message byte count	4	integer		8
2	Week number	4	integer	weeks	12
3	Seconds of week	8	double	seconds	16
4	Latitude	8	double	degrees (+ is North, - is South)	24
5	Longitude	8	double	degrees (+ is East, - is West)	32
6	Height	8	double	meters with respect to MSL	40
7	Undulation	8	double	meters	48
8	Datum ID	4	integer		56
9	StdDev of latitude	8	double	meters	60
10	StdDev of longitude	8	double	meters	68
11	StdDev of height	8	double	meters	76
12	Solution status	4	integer		84

MKTA/B Time of Mark Input

This log contains the time of the detected Mark Input pulse leading edge as detected at the Mark Input I/O port. The resolution of this measurement is 49ns. Refer to the *GPSCard Installation and Operating Manual Appendix* for the Mark Input pulse specifications.

MKTA

Structure:

\$MKTA	week	seconds	offset	offset std
utc offset	cm status	*xx	[CR][LF]	

Field #	Field type	Data Description	Example
1	\$MKTA	Log header	\$MKTA
2	week	GPS week number	653
3	seconds	Seconds into the week as measured from the receiver clock, coincident with the time of electrical closure on the Mark Input port.	338214.773382376
4	offset	Receiver clock offset, in seconds. A positive offset implies that the receiver clock is ahead of GPS Time. To derive GPS time, use the following formula: GPS time = receiver time - (offset)	0.000504070
5	offset std	Standard deviation of receiver clock offset, in seconds	0.000000013
6	utc offset	This field represents the offset of GPS time from UTC time, computed using almanac parameters. To reconstruct UTC time, algebraically subtract this correction from field 3 above (GPS seconds). UTC time = GPS time - (utc offset)	-8.000000000
7	cm status	Receiver Clock Model Status where 0 is valid and values from -20 to -1 imply that the model is in the process of stabilization	0
8	*xx	Checksum	*05
9	[CR][LF]	Sentence terminator	[CR][LF]

Example:

```
$MKTA,653,338214.773382376,0.000504070,0.000000013,-8.000000000,0 *05[CR][LF]
```

MKTB

Format: Message ID = 04 Message byte count = 52

Field #	Data	Bytes	Format	Units	Offset
1 (header)	Sync	3	char		0
	Checksum	1	char		3
	Message ID	4	integer		4
	Message byte count	4	integer		8
2	Week number	4	integer	weeks	12
3	Seconds of week	8	double	seconds	16
4	Clock offset	8	double	seconds	24
5	StdDev clock offset	8	double	seconds	32
6	UTC offset	8	double	seconds	40
7	Clock model status	4	integer		48

NAVA/B Waypoint Navigation Data

This log reports the status of your waypoint navigation progress. It is used in conjunction with the SETNAV command.

REMEMBER: The SETNAV command must be enabled before valid data will be reported from this log.

NAVA

Structure:

```
$NAVA  week  seconds  distance  bearing  along track  xtrack  etaw
etas  nav status  sol status  *xx  [CR][LF]
```

Field #	Field type	Data Description	Example
1	\$NAVA	Log header	\$NAVA
2	week	GPS week number	640
3	seconds	GPS seconds into the week	333115.00
4	distance	Straight line horizontal distance from current position to the destination waypoint, in meters (see <i>Figure C-5, Page 129</i>). This value is positive when approaching the waypoint and becomes negative on passing the waypoint.	6399.6305
5	bearing	Direction from the current position to the destination waypoint in degrees with respect to True North (or Magnetic if corrected for magnetic variation by MAGVAR command)	88.017
6	along track	Horizontal track distance from the current position to the closest point on the waypoint arrival perpendicular; expressed in meters. This value is positive when approaching the waypoint and becomes negative on passing the waypoint.	6396.9734
7	xtrack	The horizontal distance (perpendicular track-error) from the vessel's present position to the closest point on the great circle line that joins the FROM and TO waypoints. If a "track offset" has been entered in the SETNAV command, xtrack will be the perpendicular error from the "offset track". Xtrack is expressed in meters. Positive values indicate the current position is right of the Track, while negative offset values indicate left.	184.3929
8	etaw	Estimated GPS week number at time of arrival at the "TO" waypoint along-track arrival perpendicular based on current position and speed, in units of GPS weeks. If the receiving antenna is moving at a speed of less than 0.1 m/sec in the direction of the destination, the value in this field will be "9999".	657
9	etas	Estimated GPS seconds into week at time of arrival at destination waypoint along-track arrival perpendicular, based on current position and speed, in units of GPS seconds into the week. If the receiving antenna is moving at a speed of less than 0.1 m/sec in the direction of the destination, the value in this field will be "0.000".	51514.000
10	nav status	Navigation data status, where 0 = good, 1 = no velocity, and 2 = bad navigation calculation	0
11	sol status	Solution status as listed in <i>Table D-1, Page 144</i>	1
12	*xx	Checksum	*11
13	[CR][LF]	Sentence terminator	[CR][LF]

Example:

```
$NAVA,640,333115.00,6399.6305,88.017,6396.9734,184.3929,657,51514.000,0,1
*11[CR][LF]
```

NOTE: All distances and angles are calculated using Vincenty's long line geodetic equations that operate on the currently selected user datum.

See *Figure D-1, Page 177* for an illustration of navigation parameters.

NAVB

Format: Message ID = 08 Message byte count = 76

Field #	Data	Bytes	Format	Units	Offset
1 (header)	Sync	3	char		0
	Checksum	1	char		3
	Message ID	4	integer		4
	Message byte count	4	integer		8
2	Week number	4	integer	weeks	12
3	Seconds of week	8	double	seconds	16
4	Distance	8	double	meters	24
5	Bearing	8	double	degrees	32
6	Along track	8	double	meters	40
7	Xtrack	8	double	meters	48
8	ETA week	4	integer	weeks	56
9	ETA seconds	8	double	seconds	60
10	NAV status where 0 = good 1 = no velocity 2 = bad navigation	4	integer		68
11	Solution status	4	integer		72

Figure D-1 Example of Navigation Parameters

- A = FROM lat-lon
- B = TO lat-lon
- AB = Great circle line drawn between FROM A lat-lon and TO B lat-lon
- AC = Track offset from A to C
- BD = Track offset from B to D
- CD = Offset track to steer (parallel to AB)
- F = Current GPS position
- FD = Current distance and bearing from F to D
- E = Xtrack perpendicular reference point
- EF = Xtrack error from E to F (perpendicular to CD)
- FG = Along track from F to G (perpendicular to BD)

$$\begin{aligned}
 \text{AB - True bearing} &= 70^\circ \\
 \text{AB - Magnetic bearing} &= \text{True} + (\text{MAGVAR correction}) \\
 &= 70^\circ + (-20) \\
 &= 50^\circ
 \end{aligned}$$

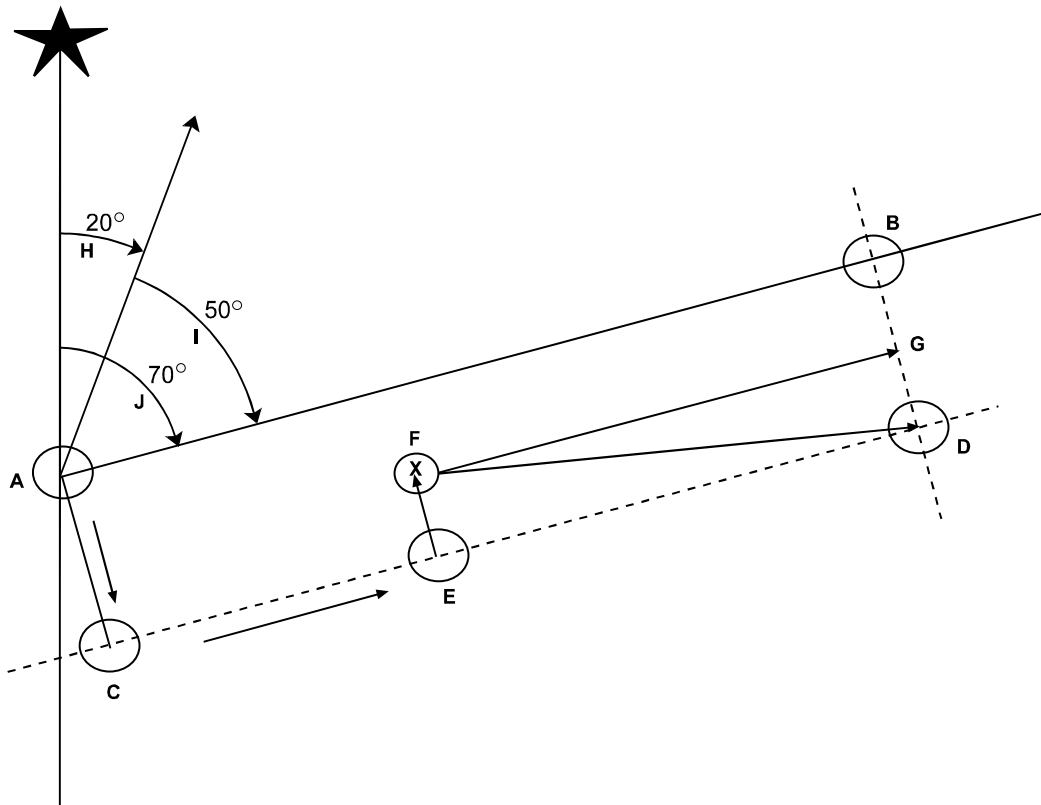

PAVA/B Position Averaging Status

These logs are meant to be used in conjunction with the POSAVE command. If the POSAVE command has not been issued, all fields in the PAVA/B logs except *week* and *seconds* will be zero. However, when position averaging is underway, the various fields contain the parameters being used in the position averaging process. The log trigger ONCHANGED is recommended, but ONTIME can also be used.

See the description of the POSAVE command, *Page 111*.

See also *Section A.3.2 Pseudorange Algorithms, Page 68*.

NOTE: All quantities are referenced to the WGS84 ellipsoid, regardless of the use of the DATUM or USERDATUM commands, except for the height parameter (field 6). The relation between the geoid and the WGS84 ellipsoid is the geoidal undulation, and can be obtained from the POSA/B logs.

PAVA

Structure :

\$PAVA	week	seconds	lat
lng	hgt	sdlat	sdlng
sdhgt	time	samples	*xx [CR][LF]

Field #	Field type	Data Description	Example
1	\$PAVA	Log header	\$PAVA
2	week	GPS week number	846
3	seconds	GPS seconds into the week	145872.00
4	lat	Average WGS84 latitude (degrees)	51.11381167
5	lng	Average WGS84 longitude (degrees)	-114.04356455
6	hgt	Average height above sea level, or geoid (m)	1068.100
7	sdlat	Estimated standard deviation of the average latitude (m)	26.2
8	sdlng	Estimated standard deviation of the average longitude (m)	12.1
9	sdhgt	Estimated standard deviation of the average height (m)	54.9
10	time	Elapsed time of averaging (s)	7
11	samples	Number of samples in the average	1
12	*xx	Checksum	*0C
13	[CR][LF]	Sentence terminator	[CR][LF]

Example:

```
$PAVA,846,145872.00,51.11381167,-114.04356455,1068.100,26.2,12.1,54.9,7,1*0C [CR][LF]
```

PAVB

Format: Message ID = 50 Message byte count = 80

Field #	Data	Bytes	Format	Units	Offset
1 (header)	Sync	3	char		0
	Checksum	1	char		3
	Message ID	4	integer		4
	Message byte count	4	integer		8
2	GPS week number	4	integer	weeks	12
3	GPS seconds into the week	8	double	seconds	16
4	Average WGS84 latitude	8	double	degrees	24
5	Average WGS84 longitude	8	double	degrees	32
6	Average height above sea level	8	double	meters	40
7	Estimated standard deviation of the average latitude	8	double	meters	48
8	Estimated standard deviation of the average longitude	8	double	meters	56
9	Estimated standard deviation of the average height	8	double	meters	64
10	Elapsed time of averaging	4	integer	seconds	72
11	Number of samples in the average	4	integer		76

POSA/B Computed Position

This log will contain the last valid position and time calculated referenced to the GPS Antenna phase centre. The position is in geographic coordinates in degrees based on your specified datum (default is WGS84). The height is referenced to mean sea level. The receiver time is in GPS weeks and seconds into the week. The estimated standard deviations of the solution and current filter status are also included. See also *Section A.3.2 Pseudorange Algorithms, Page 68*.

POSA

Structure:

\$POSA	week	seconds	lat	lon	hgt	undulation	datum ID
lat std	lon std	hgt std	sol status	*xx	[CR][LF]		

Field #	Type	Data Description	Example
1	\$POSA	Log header	\$POSA
2	week	GPS week number	637
3	seconds	GPS seconds into the week	511251.00
4	lat	Latitude of position in current datum, in degrees (DD.ddddddd). A - implies South latitude	51.11161847
5	lon	Longitude of position in current datum, in degrees (DDD.ddddddd). A + implies West longitude	-114.03922149
6	hgt	Height of position in current datum, in meters with respect to mean sea level (see <i>Figure D-2, Page 187</i>)	1072.436
7	undulation	Geoidal separation, in meters, where + is above spheroid and - is below spheroid (see <i>Figure C-6, Page 132</i>)	-16.198
8	datum ID	Current datum ID # (see <i>Table G-2, Page 240</i>)	61
9	lat std	Standard deviation of latitude solution element, in meters	26.636
10	lon std	Standard deviation of longitude solution element, in meters	6.758
11	hgt std	Standard deviation of height solution element, in meters	78.459
12	sol status	Solution status as listed in <i>Table D-1</i>	0
13	*xx	Checksum	*12
14	[CR][LF]	Sentence terminator	[CR][LF]

Example:

```
$POSA,637,511251.00,51.11161847,-114.03922149,1072.436,-16.198,61,26.636,6.758,78.459,0*12[CR][LF]
```

POSB

Format: Message ID = 01 Message byte count = 88

Field #	Data	Bytes	Format	Units	Offset
1 (header)	Sync	3	char		0
	Checksum	1	char		3
	Message ID	4	integer		4
	Message byte count	4	integer		8
2	Week number	4	integer	weeks	12
3	Seconds of week	8	double	seconds	16
4	Latitude	8	double	degrees (+ is North, - is South)	24
5	Longitude	8	double	degrees (+ is East, - is West)	32
6	Height	8	double	meters with respect to MSL	40
7	Undulation	8	double	meters	48
8	Datum ID	4	integer		56
9	StdDev of latitude	8	double	meters	60
10	StdDev of longitude	8	double	meters	68
11	StdDev of height	8	double	meters	76
12	Solution status	4	integer		84

PRTKA/B Computed Position RTK

This log contains the best available position computed by the receiver, along with three status flags. In addition, it reports other status indicators, including differential age, which is useful in predicting anomalous behavior brought about by outages in differential corrections.

This log replaces the P20A log; it is similar, but adds extended status information. With the system operating in an RTK mode, this log will reflect the latest low-latency solution for up to 30 seconds after reception of the last reference station observations. After this 30 second period, the position reverts to the best solution available; the degradation in accuracy is reflected in the standard deviation fields, and is summarized in *Table 1-2, Page 18*. If the system is not operating in an RTK mode, pseudorange differential solutions continue for 60 seconds after loss of the data link, though a different value can be set using the DGPSTIMEOUT command.

PRTKA

Structure:

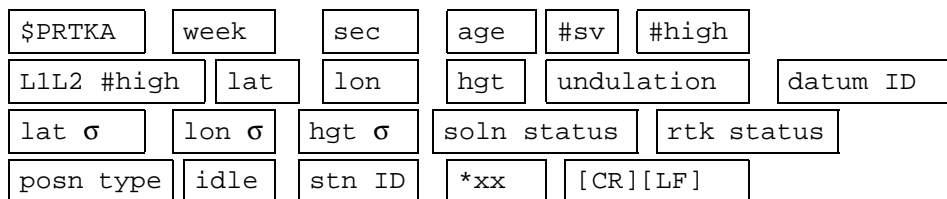

Field #	Field type	Data Description	Example
1	\$PRTKA	Log header	\$PRTKA
2	week	GPS week number	872
3	sec	GPS time into the week (in seconds)	174963.00
4	age	age of differential correction in seconds	1.000
5	#sv	Number of matched satellites; may differ from the number in view.	8
6	#high	Number of matched satellites above RTK mask angle; observations from satellites below mask are heavily de-weighted	7
7	L1L2 #high	Number of matched satellites above RTK mask angle with both L1 and L2 available	7
8	lat	Latitude of position in current datum, in decimal fraction format. A negative sign implies South latitude	51.11358042429
9	lon	Longitude of position in current datum, in decimal fraction format. A negative sign implies West longitude	-114.04358006710
10	hgt	Height of position, in meters, above mean sea level	1059.4105
11	undulation	Geoidal separation, in meters, where (+ve) is above ellipsoid and (-ve) is below ellipsoid	-16.2617
12	datum ID	Current datum (see <i>Appendix G, Page 240</i>)	61
13	lat σ	Standard deviation of latitude solution element, in meters	0.0096
14	lon σ	Standard deviation of longitude solution element, in meters	0.0100
15	hgt σ	Standard deviation of height solution element, in meters	0.0112
16	soln status	Solution status (see <i>Table D-1, Page 144</i>)	0
17	rtk status	RTK status (see <i>Tables D-3, D-4, Page 145</i>)	0
18	posn type	Position type (see <i>Table D-2, Page 145</i>)	4
19	idle	Percent idle time, percentage	42
20	stn ID	Reference station identification (RTCM: 0 - 1023, or RTCA: 266305 - 15179385)	119
21	*xx	Checksum	*51
22	[CR][LF]	Sentence terminator	[CR][LF]

Example:

```
$PRTKA,872,174963.00,1.000,8,7,7,51.11358042429,
-114.04358006710,1059.4105,-16.2617,61,
0.0096,0.0100,0.0112,0,0,4,42,119*51[CR][LF]
```

PRTKB

Format:

Message ID = 63 Message byte count = 124

Field #	Data	Bytes	Format	Units	Offset
1 (header)	Sync	3	char		0
	Checksum	1	char		3
	Message ID	4	integer		4
	Message byte count	4	integer		8
2	Week number	4	integer	weeks	12
3	GPS time into the week	8	double	seconds	16
4	Differential age	8		seconds	24
5	Number of matched satellites (00-12)	4	integer		32
6	Number of matched satellites above RTK mask angle	4	integer		36
7	Number of matched satellites above RTK mask angle with both L1 and L2 available	4	integer		40
8	Latitude	8	double	degrees	44
9	Longitude	8	double	degrees	52
10	Height above mean sea level	8	double	meters	60
11	Undulation	8	double	meters	68
12	Datum ID	4	integer		76
13	Standard deviation of latitude	8	double	meters	80
14	Standard deviation of longitude	8	double	meters	88
15	Standard deviation of height	8	double	meters	96
16	Solution status (see Table D-1, Page 144)	4	integer		104
17	RTK status (see Tables D-3, D-4, Page 145)	4	integer		108
18	Position type (see Table D-2, Page 145)	4	integer		112
19	Idle	4	integer		116
20	Reference station identification (RTCM: 0 - 1023, or RTCA: 266305 - 15179385)	4	integer		120

NOTE: For the non-RTK position types (as indicated by field 18), field 5 (#matched) indicates the number of satellites used in the pseudorange position, and fields 6 and 7 (#high and L1L2#high) indicate an estimate of the number of satellites that would be available to RTK.

PVAA/B XYZ Position, Velocity and Acceleration

The PVAA/B logs contain the receiver's latest computed position, velocity and acceleration in ECEF coordinates. The position, velocity and acceleration status fields indicate whether or not the corresponding data are valid.

This command supports INS (Inertial Navigation System) integration. PVA logs can be injected into the receiver from an INS. This information is only used by the tracking loops of the receiver to aid in reacquisition of satellites after loss of lock, otherwise it is ignored. This command is only useful for very high dynamics where expected velocity changes during the signal blockage of more than 100 meters per second can occur.

NOTE: These quantities are always referenced to the WGS84 ellipsoid, regardless of the use of the DATUM or USERDATUM commands.

PVAA

Structure:

\$PVAA	week	seconds	P-x	P-y	P-z	V-x	V-y	V-z
A-x	A-y	A-z	P-status	V-status	A-status	*xx	[CR][LF]	

Field #	Field type	Data Description	Example
1	\$PVAA	Log header	\$PVAA
2	week	GPS week number	845
3	seconds	GPS time of week (s)	344559.00
4	P-x	Position's X-coordinate (m)	-1634953.141
5	P-y	Position's Y-coordinate (m)	-3664681.855
6	P-z	Position's Z-coordinate (m)	4942249.361
7	V-x	Velocity vector along X-axis (m/s)	-0.025
8	V-y	Velocity vector along Y-axis (m/s)	0.140
9	V-z	Velocity vector along Z-axis (m/s)	0.078
10	A-x	Acceleration vector along X-axis (m/s ²)	0.000
11	A-y	Acceleration vector along Y-axis (m/s ²)	-0.000
12	A-z	Acceleration vector along Z-axis (m/s ²)	0.000
13	P-status	Position status (0 = bad; 1 = good)	1
14	V-status	Velocity status (0 = bad; 1 = good)	1
15	A-status	Acceleration status (0 = bad; 1 = good)	1
16	*xx	Checksum	*02
17	[CR][LF]	Sentence terminator	[CR][LF]

Example:

```
$PVAA,845,344559.00,-1634953.141,-3664681.855,4942249.361,-0.025,0.140,0.078,0.000,-0.000,0.000,1,1,1*02
```

PVAB

Format: Message ID = 49 Message byte count = 108

Field #	Field Type	Bytes	Format	Units	Offset
1 (header)	Sync	3	char		0
	Checksum	1	char		3
	Message ID	4	integer		4
	Message byte count	4	integer		8
2	GPS week number	4	integer	weeks	12
3	GPS time of week	8	double	seconds	16
4	Position vector along X-axis	8	double	meters	24
5	Position vector along Y-axis	8	double	meters	32
6	Position vector along Z-axis	8	double	meters	40
7	Velocity vector along X-axis	8	double	m/s	48
8	Velocity vector along Y-axis	8	double	m/s	56
9	Velocity vector along Z-axis	8	double	m/s	64
10	Acceleration vector along X-axis	8	double	m/s ²	72
11	Acceleration vector along Y-axis	8	double	m/s ²	80
12	Acceleration vector along Z-axis	8	double	m/s ²	88
13	Position status	1	integer		96
14	Velocity status	1	integer		100
15	Acceleration status	1	integer		104

1 Only the least-significant bit is used for this flag; the others are reserved for future use.

PXYA/B Computed Cartesian Coordinate Position

This log contains the last valid position, expressed in Cartesian x-y-z space coordinates, relative to the center of the Earth. The positions expressed in this log are always relative to WGS84, regardless of the setting of the DATUM or USERDATUM command. See *Figure D-2, Page 187* for a definition of the coordinates.

PXYA

Structure:

\$PXYA	week	seconds	x	y	z	x std	y std	z std	sol status
fix status	diff age	*xx	[CR][LF]						

Field #	Field type	Data Description	Example
1	\$PXYA	Log header	\$PXYA
2	week	GPS week number	713
3	seconds	GPS seconds into the week	488150.00
4	x	Position x coordinate, in meters	-1634756.995
5	y	Position y coordinate, in meters	-3664965.028
6	z	Position z coordinate, in meters	4942151.391
7	x std	Standard deviation of x, in meters	2.335
8	y std	Standard deviation of y, in meters	3.464
9	z std	Standard deviation of z, in meters	4.156
10	sol status	Solution status as listed in <i>Table D-1</i>	0
11	fix status	0 = fix not available or invalid 1 = Single point stand-alone fix 2 = Differential fix	2
12	diff age ¹	Age of differential correction (seconds) (= 0 if fix status ≠ 2)	0.4
13	*xx	Checksum	*08
14	[CR][LF]	Sentence terminator	[CR][LF]

¹ This log provides differential fix and age status.

Example:

```
$PXYA,713,488150.00,-1634756.995,-3664965.028,4942151.391,2.335,3.464,
4.156,0,2,0.4*08[CR][LF]
```

PXYB

Format: Message ID = 26 Message byte count = 88

Field #	Data	Bytes	Format	Units	Offset	
1 (header)	Sync	3	char		0	
	Checksum	1	char		3	
	Message ID	4	integer		4	
	Message byte count	4	integer		8	
2	Week number	4	integer	weeks	12	
3	Seconds of week	8	double	seconds	16	
4	x	8	double	meters	24	
5	y	8	double	meters	32	
6	z	8	double	meters	40	
7	StdDev of x	8	double	meters	48	
8	StdDev of y	8	double	meters	56	
9	StdDev of z	8	double	meters	64	
10	Solution status	4	integer		72	
11	Fix status	1	4	integer	76	
12	Age of differential corrections	1	8	double	seconds	80

1 This log provides differential fix and age status.

Figure D-2 The WGS84 ECEF Coordinate System

Definitions:

- Origin = Earth's centre of mass
- Z-Axis = Parallel to the direction of the Conventional Terrestrial Pole (CTP) for polar motion, as defined by the Bureau International de l'Heure (BIH) on the basis of the coordinates adopted for the BIH stations.
- X-Axis = Intersection of the WGS 84 Reference Meridian Plane and the plane of the CTP's Equator, the Reference Meridian being parallel to the Zero Meridian defined by the BIH on the basis of the coordinates adopted for the BIH stations.
- Y-Axis = Completes a right-handed, earth-centered, earth fixed (ECEF) orthogonal coordinates system, measured in the plane of the CTP Equator, 90 degrees East of the X-Axis.

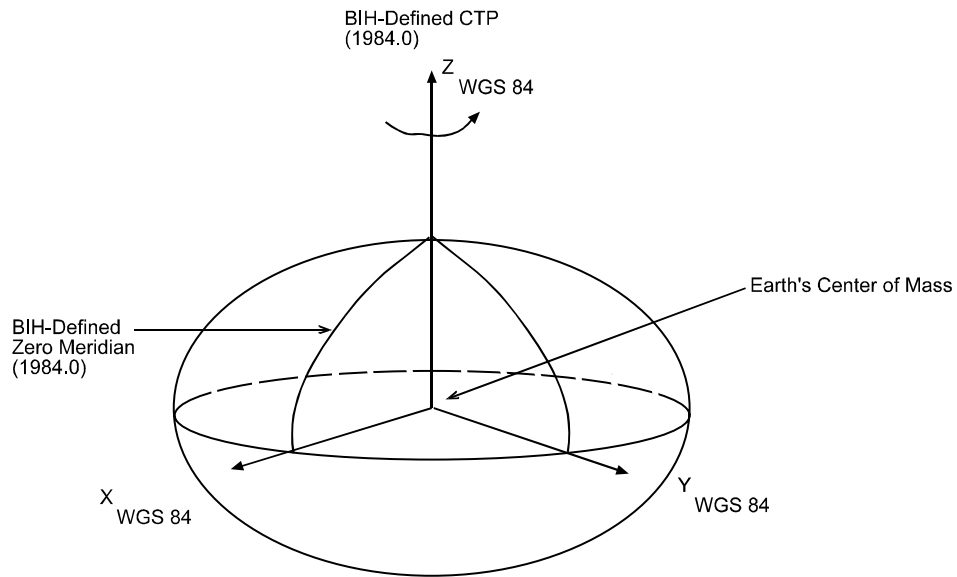

Analogous to the BIH Defined Conventional Terrestrial Standard System (CTS), or BTS.

RALA/B Raw Almanac

Almanac and health data are contained in subframes four and five of the satellite broadcast message. Subframe four contains information for SVs 25-32, as well as ionospheric, UTC and SV configuration data. Subframe five contains information for SVs 1-24.

Subframes four and five each contain 25 pages of data, and each page contains ten 30-bit words of information as transmitted from the satellite. The RALA/B log outputs this information with parity bits checked and removed (ten words - 24 bits each). The log will not be generated unless all ten words pass parity.

This log will alternately report each page from subframes four and five as they are collected. Logging this log onnew would be the optimal logging rate to capture data from pages in subframes four and five as they are received.

RALA logs contain a hex representation of the raw almanac data (one of the possible 25 pages of either subframe 4 or 5). RALB contains the raw binary information.

RALA

Structure:

```
$RALA chan # prn subframe *xx [CR][LF]
```

Field #	Field type	Data Description	Example
1	\$RALA	Log header	\$RALA
2	chan #	SV channel number collecting almanac data (0-11)	7
3	prn	PRN of satellite from which data originated	16
4	subframe	Subframe 4 or 5 of almanac data (60 hex characters)	8B0A54852C964C661F086366FDBE00A10D53DA6565F2503DD7C2AACBFED3
5	*xx	Checksum	*05
6	[CR][LF]	Sentence terminator	[CR][LF]

Example:

```
$RALA,7,16,8B0A54852C964C661F086366FDBE00A10D53DA6565F2503DD7C2AACBFED3
*05[CR][LF]
```

RALB

Format: Message ID = 15 Message byte count = 52

Field #	Data	Bytes	Format	Units	Offset
1 (header)	Sync	3	char		0
	Checksum	1	char		3
	Message ID	4	integer		4
	Message byte count	4	integer		8
2	SV channel number, 0-11	4	integer		12
3	PRN number, 1-32	4	integer		16
4	Almanac data, data [30]	30	char		20
5	Filler bytes	2	char		50

RASB

Format: Message ID = 66 Message byte count = $40 + (n * 32)$

Field #	Data	Bytes	Format	Units	Offset
1	Sync	3	char		0
	Checksum	1	char		3
	Message ID	4	integer		4
	Message byte count	4	integer		8
2	Week data received	4	integer	weeks	12
3	Approximate seconds into week data received	8	double	seconds	16
4	Almanac reference week	4	integer	weeks	24
5	Almanac reference seconds	4	integer	seconds	28
6	PRN of satellite from which data originated	4	integer		32
7	Number of subframes to follow	4	integer		36
8	Subframe number	1	char		40
9	Page number	1	char		41
10...	Next PRN offset = $40 + (\text{obs} * 32)$				

Note: Variable Length = $40 + (n * 32)$. Maximum = $40 + (50 * 32) = 1640$. Typical size (31 subframes) = 1032 bytes.

RBTA/B Satellite Broadcast Data: Raw Bits

This message contains the satellite broadcast data in raw bits before FEC (forward error correction) decoding or any other processing. An individual message is sent for each PRN being tracked. For a given satellite, the message number increments by one each time a new message is generated. This data matches the SBTA/B data if the message numbers are equal. The data must be logged with the 'onnew' trigger activated to prevent loss of data.

RBTA

Structure:

\$RBTA	week	seconds	prn	cstatus	message #	# of bits
raw bits	*xx	[CR][LF]				

Field #	Field type	Data Description	Example
1	\$RBTA	Log header	\$RBTA
2	week	GPS week number	883
3	seconds	GPS seconds into the week	413908.000
4	prn	PRN of satellite from which data originated	115
5	cstatus	Channel Tracking Status	80812F14
6	message #	Message sequence number	119300
7	# of bits	Number of bits transmitted in the message. At present, always equals 256 bits.	256
8	raw bits	256 bits compressed into 32 bytes. Hence, 64 hex characters are output.	30FB30FB30FB30F878DA621 94000F18322931B9EBDBC1C BC9324B68FBDAEBE8A
9	*xx	Checksum	*42
10	[CR][LF]	Sentence terminator	[CR][LF]

RBTB

Format: Message ID = 52 Message byte count = 72

Field #	Data	Bytes	Format	Units	Offset
1 (header)	Sync	3	char		0
	Checksum	1	char		3
	Message ID	4	integer		4
	Message byte count	4	integer	bytes	8
2	Week number	4	integer	weeks	12
3	Seconds of week	8	double	seconds	16
4	PRN number	4	integer	1-999	24
5	Channel Status	4	integer	n/a	28
6	Message #	4	integer	n/a	32
7	# of Bits	4	integer	n/a	36
8	Raw Bits	32	char	n/a	40

RCCA Receiver Configuration

This log outputs a list of all current GPSCard command settings. Observing this log is a good way to monitor the GPSCard configuration settings. See *Chapter 2, Page 25* for the RCCA default list.

```

$RCCA,COM1,57600,N,8,1,N,OFF,ON*10
$RCCA,COM1_DTR,HIGH*70
$RCCA,COM1_RTS,HIGH*67
$RCCA,ACCEPT,COM1,COMMANDS*5B
$RCCA,COM2,9600,N,8,1,N,OFF,ON*28
$RCCA,COM2_DTR,HIGH*73
$RCCA,COM2_RTS,HIGH*64
$RCCA,ACCEPT,COM2,COMMANDS*58
$RCCA,UNDULATION,TABLE*56
$RCCA,DATUM,WGS84*15
$RCCA,USERDATUM,6378137.000,298.257223563,0.000,0.000,0.000,0.000,0.000,0.000*6A
$RCCA,SETNAV,DISABLE*5C
$RCCA,MAGVAR,0.000,30.000*02
$RCCA,DYNAMICS,AIR*4F
$RCCA,UNASSIGNALL*64
$RCCA,UNLOCKOUTALL*20
$RCCA,RESETHEALTHALL*37
$RCCA,UNFIX*73
$RCCA,ANTENNAPOWER ON*1E
$RCCA,SETDGP SID,ALL*1D
$RCCA,RTCMRULE,6CR*32
$RCCA,RTCM16T,*48
$RCCA,CSMOOTH,20.00,20.00*7E
$RCCA,ECUTOFF,0.00*45
$RCCA,FREQUENCY_OUT,DISABLE*12
$RCCA,EXTERNALCLOCK,DISABLE*12
$RCCA,CLOCKADJUST,ENABLE*47
$RCCA,SETTIMESYNC,DISABLE*17
$RCCA,SETL1OFFSET,0.000000*3F
$RCCA,MESSAGES,ALL,ON*67
$RCCA,DGPSTIMEOUT,60.00,120.00*51
$RCCA,SAVEALMA,ONNEW*4E
$RCCA,POSAVE,DISABLE*59
$RCCA,RTKMODE,DEFAULT*16
$RCCA,CONFIG,STANDARD*02
$RCCA,DIFF_PROTOCOL,DISABLED*47
$RCCA,IONOMODEL,CALCULATED*5B
$RCCA,WAASCORRECTION,DISABLE*55
$RCCA,LOG,COM1,PRTKB,ONTIME,10.00*6F
$RCCA,LOG,COM1,MKPB,ONNEW*6E
$RCCA,LOG,COM1,POSB,ONTIME,1.00*0E

```

RCSA/B Receiver Status

The RCSA log will always output four records: one for VERSION, one for receiver CHANNELS, one for receiver CPU IDLE time, and one indicating receiver self-test STATUS. However, RCSB will embed the same information in a single record.

Together, the RVSA/B and VERA/B logs supersede the RCSA/B logs. In other word this log is soon to be obsolete and eventually will be no longer supported. It is recommended then that you use the RVSA/B and VERA/B logs.

RCSA

Structure:

\$RCSA	VERSION	sw ver	*xx	[CR][LF]
\$RCSA	CHANNELS	# chans	*xx	[CR][LF]
\$RCSA	IDLE	idle time	*xx	[CR][LF]
\$RCSA	STATUS	rec status	*xx	[CR][LF]

Log	Data Identifier	Data Description	Checksum	String End
\$RCSA	VERSION	sw ver: Software information indicating model, S/N, S/W version and S/W version date	*xx	[CR][LF]
\$RCSA	CHANNELS	# chans: Indicates number of parallel channels on GPSCard	*xx	[CR][LF]
\$RCSA	IDLE	idle time: An integer number representing percent idle time for the CPU, with a valid range of 0 to 99	*xx	[CR][LF]
\$RCSA	STATUS	rec status: Indicates result of hardware self-test and software status as shown in <i>Table D-5, Page 198</i>	*xx	[CR][LF]

Example:

```
$RCSA,VERSION,GPSCard-2 3951R LGR94160001 HW 16 SW 3.15 Mar 31/94*16
$RCSA,CHANNELS,10*12
$RCSA,IDLE,40*03
$RCSA,STATUS,000007F6*60
```

The status code is a hexadecimal number representing the results of the GPSCard BIST test and software status. As an example, the status code '00000F6' indicates that the GPSAntenna is not working properly or is disconnected and the GPSCard is good, while '00000F7' indicates that the GPSAntenna and the GPSCard are both functioning properly. See *Table D-5, Page 198* for a detailed description of the status code. Bit 0 is the least significant bit of the status code and Bit 16 is the most significant bit.

RCSB

Format: Message ID = 13 Message byte count = 100

Field #	Data	Bytes	Format	Offset
1 (header)	Sync	3	char	0
	Checksum	1	char	3
	Message ID	4	integer	4
	Message byte count	4	integer	8
2	Software version #, ASCII	80	char	12
3	Number of receiver channels	1	char	92
4	CPU idle time, percent	1	char	93
5	Filler	2	bytes	94
6	Self-test status	4	integer	96

NOTE 1: See Table D-5 for a detailed GPSCard Receiver Self-test Status Code table and bit descriptions.

NOTE 2: Self test bits 2, 3, 4, 6, 7 are set only once when the GPSCard is first powered up. All other bits are set by internal test processes each time the RCSA/B log is output.

REPA/B Raw Ephemeris

REPA

This log contains the raw Binary information for subframes one, two and three from the satellite with the parity information removed. Each subframe is 240 bits long (10 words - 24 bits each) and the log contains a total 720 bits (90 bytes) of information (240 bits x 3 subframes). This information is preceded by the PRN number of the satellite from which it originated. This message will not be generated unless all 10 words from all 3 frames have passed parity.

Ephemeris data whose toe (time of ephemeris) is older than six hours will not be shown.

Structure:

```
$REPA  prn  subframe1  subframe2  subframe3  *xx  [CR][LF]
```

Field #	Field type	Data Description	Example
1	\$REPA	Log header	\$REPA
2	prn	PRN of satellite from which data originated	14
3	subframe1	Subframe 1 of ephemeris data (60 hex characters)	8B09DC17B9079DD7007D5D E404A9B2D 04CF671C6036612560000021 804FD
4	subframe2	Subframe 2 of ephemeris data (60 hex characters)	8B09DC17B98A66FF713092F 12B359D FF7A0254088E1656A10BE2F F125655
5	subframe3	Subframe 3 of ephemeris data (60 hex characters)	8B09DC17B78F0027192056E AFFDF2724C 9FE159675A8B468FFA8D066 F743
6	*xx	Checksum	*57
7	[CR][LF]	Sentence terminator	[CR][LF]

Example:

```
$REPA,14,8B09DC17B9079DD7007D5DE404A9B2D04CF671C6036612560000021804FD,  
8B09DC17B98A66FF713092F12B359DFF7A0254088E1656A10BE2FF125655,  
8B09DC17B78F0027192056EAFDF2724C9FE159675A8B468FFA8D066F743*57[CR][LF]
```

REPB

Format: Message ID = 14 Message byte count = 108

Field #	Data	Bytes	Format	Offset
1 (header)	Sync	3	char	0
	Checksum	1	char	3
	Message ID	4	integer	4
	Message byte count	4	integer	8
2	PRN number, 1-32	4	integer	12
3-4-5	Ephemeris data, data [90]	90	char	16
	Filler bytes	2	char	106

RGEA/B/D Channel Range Measurements

RGEA/B/D contain the channel range measurements for the currently observed satellites. The RGED message is a compressed form of the RGEB message. When using these logs, please keep in mind the constraints noted along with the description.

It is important to ensure that the receiver clock has been set and can be monitored by the bits in the *rec-status* field. Large jumps in range as well as ADR will occur as the clock is being adjusted. If the ADR measurement is being used in precise phase processing it is important not to use the ADR if the "parity known" flag in the *ch-tr-status* field is not set as there may exist a half (1/2) cycle ambiguity on the measurement. The tracking error estimate of the pseudorange and carrier-phase (ADR) is the thermal noise of the receiver tracking loops only. It does not account for possible multipath errors or atmospheric delays.

RGEA and RGEB contain all of the new extended channel tracking status bits (see *Table D-7, Page 203*), while RGED contains only the lowest 24 bits. The receiver self-test status word (see *Table D-5, Page 198*) now also indicates L2, OCXO and new almanac status.

If both the L1 and L2 signals are being tracked for a given PRN, two entries with the same PRN will appear in the range logs. As shown in *Table D-7 (Channel Tracking Status)*, these entries can be differentiated by bit 19, which is set if there are multiple observables for a given PRN, and bit 20, which denotes whether the observation is for L1 or L2. This is to aid in parsing the data.



RGEA

Structure:

```

$RGEA  week  seconds  # obs  rec status
prn  psr  psr std  adr  adr std  dopp  C/No  locktime  ch-tr-status
:
prn  psr  psr std  adr  adr std  dopp  C/No  locktime  ch-tr-status
*xx  [CR][LF]
    
```

Field #	Field type	Data Description	Example
1	\$RGEA	Log header	\$RGEA
2	week	GPS week number	845
3	seconds	GPS seconds into the week	511089.00
4	# obs	Number of satellite observations with information to follow	14
5	rec status	Receiver self-test status, see <i>Table D-5, Page 198</i> .	000B20FF ¹
6	prn	Satellite PRN number (1-32) of range measurement	4
7	psr	Pseudorange measurement (m)	23907330.296
8	psr std	Pseudorange measurement standard deviation (m)	0.119
9	adr	Carrier phase, in cycles (accumulated Doppler range)	-125633783.992
10	adr std	Estimated carrier phase standard deviation (cycles)	0.010
11	dopp	Instantaneous carrier Doppler frequency (Hz)	3714.037
12	C/N ₀	Carrier to noise density ratio C/N ₀ = 10[log ₁₀ (S/N ₀)] (dB-Hz)	44.8
13	locktime	Number of seconds of continuous tracking (no cycle slipping)	1928.850
14	ch-tr-status	Hexadecimal number indicating phase lock, channel number and channel tracking state, as shown in <i>Table D-7</i> .	82E04
...	...	Next PRN #, psr, psr std, adr, adr std, dopp, C/No, locktime, ch-tr-status	
...	
...	...	Last PRN #, psr, psr std, adr, adr std, dopp, C/No, locktime, ch-tr-status	
variable	*xx	Checksum	*30
variable	[CR][LF]	Sentence terminator	[CR][LF]

1 This output will always be a hexadecimal representation which must be converted to binary format. In this example, the conversion gives 00000000000101100100000111111111 in binary format, see *Appendix H, Page 242* for a complete conversion list. Reading from right to left you can look to see what each bit represents in *Table D-5, following*.

Example (carriage returns have been added between observations for clarity):

```

$RGEA, 845, 511089.00, 14, 000B20FF
4, 23907330.296, 0.119, -125633783.992, 0.010, 3714.037, 44.8, 1928.850, 82E04,
4, 23907329.623, 1.648, -97896180.284, 0.013, 2894.285, 35.0, 1746.760, 582E0B,
2, 21298444.942, 0.040, -111954153.747, 0.006, -1734.838, 54.2, 17466.670, 82E14,
2, 21298444.466, 0.637, -87236867.557, 0.006, -1351.607, 43.3, 17557.260, 582E1B,
9, 22048754.383, 0.063, -115874135.450, 0.006, 2174.006, 50.4, 5489.100, 82E24,
9, 22048754.424, 0.641, -90291443.071, 0.006, 1694.238, 43.2, 5489.100, 582E2B,
15, 23191384.847, 0.261, -121887295.980, 0.017, -2069.744, 38.0, 9924.740, 82E34,
15, 23191384.663, 0.596, -94977002.452, 0.010, -1612.587, 43.8, 9881.830, 582E3B,
26, 24063897.737, 0.199, -126477739.189, 0.014, -2654.682, 40.3, 12821.640, 82E54,
26, 24063898.913, 1.043, -98553986.239, 0.013, -2068.380, 39.0, 12793.280, 582E5B,
7, 20213352.139, 0.037, -106237901.461, 0.005, 439.943, 55.0, 10313.040, 82E74,
7, 20213351.196, 0.498, -82782498.454, 0.007, 343.020, 45.4, 9977.400, 582E7B,
27, 24393726.829, 0.123, -128229016.323, 0.012, -4047.338, 44.5, 22354.119, 82E94,
27, 24393728.057, 1.805, -99918535.513, 0.013, -3153.559, 34.2, 22301.830, 582E9B
*30
    
```

RGEB

Format: Message ID = 32 Message byte count = 32 + (obs x 44)

Field #	Data	Bytes	Format	Units	Offset
1 (header)	Sync	3	char		0
	Checksum	1	char		3
	Message ID	4	integer		4
	Message byte count	4	integer		8
2	Week number	4	integer	weeks	12
3	Seconds of week	8	double	seconds	16
4	Number of observations (obs)	4	integer		24
5	Receiver self-test status	4	integer		28
6	PRN	4	integer		32
7	Pseudorange	8	double	meters	36
8	StdDev pseudorange	4	float	meters	44
9	Carrier phase - accumulated Doppler range, cycles	8	double		48
10	StdDev - accumulated Doppler range, cycles	4	float		56
11	Doppler frequency	4	float	Hz	60
12	C/N ₀	4	float	dB-Hz	64
13	Locktime	4	float	seconds	68
14	Tracking status	4	integer		72
15...	Next PRN offset = 32 + (obs x 44)				

RGED

Format: Message ID = 65 Message byte count = 24 + (20 x number of obs)

Field #	Data	Bytes	Format	Scale	Offset
1 (header)	Sync	3	char		0
	Checksum	1	char		3
	Message ID	4	integer		4
	Message byte count	4	integer		8
2	Number of obs	2		1	12
3	Week number	2		1	14
4	Seconds of week	4	integer	1/100	16
5	Receiver status	4	integer	1	20
6	First PRN range record	20	See Table D-6, Page 201		24
Next PRN offset = 24 + (20 x number of obs)					



Table D-5 Receiver Self-Test Status Codes

N7	N 6			N 5			N 4			N 3			N 2			N 1			N 0			Bit = Number	Description	Range Values	Hex Value						
	27	26	25	24	23	22	21	20	19	18	17	16	15	14	13	12	11	10	9	8	7					6	5	4	3	2	1
																												0	1=good, 0=bad	00000001	
																												1	L1 PLL	1=good, 0=bad	00000002
																												2	RAM	1=good, 0=bad	00000004
																												3	ROM	1=good, 0=bad	00000008
																												4	DSP	1=good, 0=bad	00000010
																												5	L1 AGC	1=good, 0=bad	00000020
																												6	COM1	1=good, 0=bad	00000040
																												7	COM2	1=good, 0=bad	00000080
																												8	WEEK	1=not set, 0=set	00001000
																												9	NO COARSE TIME	1=not set, 0=set	00002000
																												10	NO FINE TIME	1=not set, 0=set	00004000
																												11	L1 JAMMER	1=present, 0=normal	00008000
																												12	BUFFER COM1	1=overrun, 0=normal	00010000
																												13	BUFFER COM2	1=overrun, 0=normal	00020000
																												14	BUFFER CONSOLE	1=overrun, 0=normal	00040000
																												15	CRU OVERLOAD	1=overload, 0=normal	00080000
																												16	ALMANAC SAVED IN NVM	1=yes, 0=no	00100000
																												17	L2 AGC	1=good, 0=bad	00200000
																												18	L2 JAMMER	1=present, 0=normal	00400000
																												19	L2 PLL	1=good, 0=bad	00800000
																												20	OCXO PLL	1=good, 0=bad	01000000
																												21	SAVED ALMA NEEDS UPDATE	1=yes, 0=no	02000000
																												22	ALMANAC INVALID	1=invalid, 0=valid	04000000
																												23	POSITION SOLUTION INVALID	1=invalid, 0=valid	08000000
																												24	POSITION FIXED	1=yes, 0=no	01000000
																												25	CLOCK MODEL INVALID	1=invalid, 0=valid	02000000
																												26	CLOCK STEERING DISABLED	1=disabled, 0=enabled	04000000
																												27	RESERVED		
																												28-31	RESERVED		

Notes on Table D-5:

- 1. Bit 3:** On OEM GPSCards, “ROM” includes all forms of non-volatile memory.
- 2. Bits 12-15:** Flag is reset to 0 five minutes after the last overrun/overload condition has occurred.

GPSCard example: All OK = 0000 0000 0000 1010 0000 0000 1111 1111 (binary) = 000A00FF (hexadecimal); using a VCTCXO oscillator.

RECEIVER STATUS - DETAILED BIT DESCRIPTIONS OF SELF-TEST**Bit 0 Antenna**

- 1 This bit will be set to 1 if the antenna connection is not drawing excessive current.
- 0 If the antenna connections are shorted together then this bit will be clear (0) indicating a possible antenna port problem.

Bit 1 L1 PLL

- 1 When the L1 RF downconverter passes self-test, the bit will be set to 1.
- 0 If a fault is detected in the L1 RF downconverter, this bit is set to 0.

Bit 2 RAM

- 1 When this bit is set to 1, the receiver RAM has passed the self-test requirements.
- 0 If the bit has been set to 0, then RAM test has failed; please contact NovAtel Customer Service.

Bit 3 ROM (Note: “ROM” includes all forms of nov-volatile memory (NVM))

- 1 When this bit is set to 1, the receiver ROM test has passed the self test requirements.
- 0 A zero bit indicates the receiver has failed the ROM test.

Bit 4 DSP

- 1 This bit will be set to 1 when the digital signal processors (DSP) have passed the self-test requirements.
- 0 0 indicates one or both of the DSP chips has failed self-test; please contact NovAtel Customer Service.

Bit 5 L1 AGC

- 1 When set to 1, the L1AGC circuits are operating within normal range of control.
- 0 This bit will be set clear if the L1 AGC is operating out of normal range. Intermittent setting of the AGC bit indicates that the card is experiencing some electro-magnetic interference of a very short duration. Continuous setting of the AGC bit may indicate that the card is receiving too much signal power from the antenna or that a more serious problem with the card may exist. Failure of this test could be the result of various possibilities, such as: bad antenna LNA, excessive loss in the antenna cable, faulty RF downconverter, or a pulsating or high power jamming signal causing interference. If this bit is continuously set clear, and you cannot identify an external cause for the failed test, please contact NovAtel Customer Service.

Bit 6 COM1

- 1 When set to 1, the COM1 UART has passed the self-test requirements.
- 0 If set to 0, the COM1 UART has failed self-test and cannot be used for reliable communications.

Bit 7 COM2

- 1 When set to 1, the COM2 UART has passed the self-test requirements.
- 0 If set to 0, the COM2 UART has failed self-test and cannot be used for reliable communications.

Bits 8, 9, 10 Week / No Coarsetime / No Finetime

- 0 These bits indicate the state of the receiver time and are set only once, generally in the first few minutes of operation, in the presence of adequate numbers of satellite signals to compute position and time.
- 1 If these bits are not all set to zero, then the observation data, pseudorange measurement, carrier-phase, and Doppler measurements may jump as the clock adjusts itself.

Bit 11 L1 Jammer Detection

- 0 Normal operation is indicated when this bit is 0.

- 1 If set to 1, the receiver has detected a high power signal causing interference. When this happens, the receiver goes into a special anti-jamming mode where it re-maps the A/D decode values as well as special L1AGC feedback control. These adjustments help to minimize the loss that will occur in the presence of a jamming signal. You should monitor this bit, and if set to 1, do your best to remedy the cause of the jamming signal. Nearby transmitters or other electronic equipment could be the cause of interference; you may find it necessary to relocate your antenna position if the problem persists.

Bits 12, 13, 14 Buffer COM 1 / COM 2

- 0 Normal operation is indicated by a 0 value.
- 1 These bits are set to 1 to inform the user when any of the 8-Kilobyte output buffers have reached an over-run condition (COM1 or COM2). Over-run is caused by requesting more log data than can be taken off the GPSCard because of bit rate limitations or slow communications equipment. If this happens, the new data attempting to be loaded into the buffer will be discarded. The receiver will not load a partial data record into an output buffer. The flag resets to 0 five minutes after the last overrun occurred.

Bit 15 CPU Overload

- 0 Normal operation is indicated by a 0 value.
- 1 A value of 1 indicates that the CPU is being over-taxed. This may be caused by requesting an excessive amount of information from the GPSCard. If this condition is occurring, limit redundant data logging or change to using binary data output formats, or both. You should attempt to tune the logging requirements to keep the idle time above 20% for best operation. If the average idle % drops below 10% for prolonged periods of time (2-5 seconds), critical errors may result in internal data loss and the over-load bit will be set to 1. You can monitor the CPU % idle time by using the RvSA log message. The flag resets to 0 five minutes after the first overload occurred.

NOTE: As the amount of CPU power becomes limited, the software will begin to slow down the position calculation rate. If the CPU becomes further limited, the software will begin to skip range measurement processing. Priority processing goes to the tracking loops.

Bit 16 Almanac Saved

- 0 Almanac not saved in non-volatile memory.
- 1 Almanac saved in non-volatile memory (12 channel OEM cards only).

Bit 17 L2 AGC

- 1 When set to 1, the L2 AGC circuits are operating within normal range of control.
- 0 This bit will be set clear if the L2 AGC is operating out of normal range. Intermittent setting of the AGC bit indicates that the card is experiencing some electro-magnetic interference of a very short duration. Continuous setting of the AGC bit may indicate that the card is receiving too much signal power from the antenna or that a more serious problem with the card may exist. Failure of this test could be the result of various possibilities, such as: bad antenna LNA, excessive loss in the antenna cable, faulty RF downconverter, or a pulsating or high power jamming signal causing interference. If this bit is continuously set clear, and you cannot identify an external cause for the failed test, please contact NovAtel Customer Service.

Bit 18 L2 Jammer Detection

- 0 Normal operation is indicated when this bit is 0.
- 1 If set to 1, the receiver has detected a high power signal causing interference. When this happens, the receiver goes into a special anti-jamming mode where it re-maps the A/D decode values as well as special L2AGC feedback control. These adjustments help to minimize the loss that will occur in the presence of a jamming signal. You should monitor this bit, and if set to 1, do your best to remedy the cause of the jamming signal. Nearby transmitters or other electronic equipment could be the cause of interference; you may find it necessary to relocate your antenna position if the problem persists.

Bit 19 L2 PLL

- 1 When the L2 RF downconverter passes self-test, the bit will be set to 1.
- 0 If a fault is detected in the L2 RF downconverter, this bit is set to 0.

Bit 20 OCXOPLL

- 1 When an external oscillator is connected and the OCXOPLL bit passes self-test, the bit will be set to 1.
- 0 If no external oscillator is detected or a fault is detected in the OCXOPLL bit, this bit is set to 0.

Bit 21 Saved Almanac Needs Update

- 1 When the almanac received is newer than the one currently stored in NVM (non-volatile memory), the bit will be set to 1.
- 0 This bit will be set to 0 if an almanac has not been received that is newer than the one stored in memory.

Bit 22 Almanac Invalid

- 1 No almanac in use
- 0 Valid almanac in use

Bit 23 Position Solution Invalid

- 1 Position solution is not valid
- 0 Valid position computed

Bit 24 Position Fixed

- 1 A fix position command has been accepted
- 0 Position has not been fixed

Bit 25 Clock Model Invalid

- 1 Clock model has not stabilized
- 0 Clock model is valid

Bit 26 Clock Steering Disabled

- 1 Clockadjust disable command has been accepted
- 0 Clockadjust is enabled

Table D-6 Range Record Format (RGED only)

Data	Bit(s) from first to last	Length (bits)	Format	Scale Factor
PRN 1A, 1B	0..5	6	integer	1
C/No	6..10	5	integer	(20+n) dB-Hz
Lock time	11..31	21	integer	1/32 s
ADR	32..63	32	integer 2's comp.	1/256 cycles
Doppler frequency	68..95	28	integer 2's comp.	1/256 Hz
Pseudorange	64..67 msn; 96..127 lsw	36	integer 2's comp.	1/128 m
StdDev - ADR	128..131	4	integer	(n+1) / 512 cyc
StdDev - pseudorange	132..135	4		see ⁵
Channel Tracking status ⁶	136..159	24	integer	see Table D-7, Page 203

Notes on Table D-6:

- 1A Only PRNs 1 - 63 are reported correctly (Note: while there are only 32 PRNs in the basic GPS scheme, situations exist which require the use of additional PRNs)
- 1B The prn offsets for WAAS have been mapped to the same range as GPS, i.e. 1 - 19, while the prn offsets for GLONASS are 1 - 29.
- 2 C/No is constrained to a value between 20 - 51 dB-Hz. Thus, if it is reported that C/No = 20 dB-Hz, the actual value could be less. Likewise, if it is reported that C/No = 51 dB-Hz, the true value could be greater.
- 3 Lock time rolls over after 2,097,151 seconds.

4 ADR (Accumulated Doppler Range) is calculated as follows:

$$\text{ADR_ROLLS} = (-\text{RGED_PSR} / \text{WAVELENGTH} - \text{RGED_ADR}) / \text{MAX_VALUE}$$

Round to the closest integer

IF (ADR_ROLLS \leq -0.5)

$$\text{ADR_ROLLS} = \text{ADR_ROLLS} - 0.5$$

ELSE

$$\text{ADR_ROLLS} = \text{ADR_ROLLS} + 0.5$$

At this point integerise ADR_ROLLS

$$\text{CORRECTED_ADR} = \text{RGED_ADR} - (\text{MAX_VALUE} * \text{ADR_ROLLS})$$

where:

ADR has units of cycles

WAVELENGTH = 0.1902936727984 for L1

WAVELENGTH = 0.2442102134246 for L2

MAX_VALUE = 8388608

5

Code	RGED
0	0.000 to 0.050
1	0.051 to 0.075
2	0.076 to 0.113
3	0.114 to 0.169
4	0.170 to 0.253
5	0.254 to 0.380
6	0.381 to 0.570
7	0.571 to 0.854
8	0.855 to 1.281
9	1.282 to 2.375
10	2.376 to 4.750
11	4.751 to 9.500
12	9.501 to 19.000
13	19.001 to 38.000
14	38.001 to 76.000
15	76.001 to 152.000

6 Only bits 0 - 23 are represented in the RGED log

Table D-7 Channel Tracking Status

N 7		N 6		N 5		N 4		N 3		N 2		N 1		N 0		<< Nibble Number															
31	30	29	28	27	26	25	24	23	22	21	20	19	18	17	16	15	14	13	12	11	10	9	8	7	6	5	4	3	2	1	0
																		Bit	Description	Range Values	Hex.										
																		lsb = 0			1										
																		1	Tracking state	0 - 11 See below	2										
																		2			4										
																		3			8										
																		4			10										
																		5			20										
																		6	SV channel number	0 - n (0 = first, n = last) (n depends on GPSCard)	40										
																		7			80										
																		8			100										
																		9	Phase lock flag	1 = Lock, 0 = Not locked	200										
																		10	Parity known flag	1 = Known, 0 = Not known	400										
																		11	Code locked flag	1 = Lock, 0 = Not locked	800										
																		12			1000										
																		13	Correlator spacing	0 - 7 See below	2000										
																		14			4000										
																		15			8000										
																		16	Satellite system	0=GPS 1=GLONASS 2=WAAS 3= Pseudolite 4-7 Reserved	10000										
																		17			20000										
																		18	Reserved		40000										
																		19	Grouping *	1 = Grouped, 0 = Not grouped	80000										
																		20	Frequency	1 = L2, 0 = L1	100000										
																		21	Code type	0 = CA 2 = P-codeless 1 = P 3 = Reserved	200000										
																		22			400000										
																		23	Forward error correction	1 = FEC enabled, 0 = no FEC	800000										
																		24													
																		:	Reserved												
																		25													
																		30	External range	1 = Ext. range, 0 = Int. range											
																		31	Channel assignment	1 = Forced, 0 = Automatic											

* Grouped: A channel has an associated channel (L1/L2 pairs in MiLLennium and L1/L1 pairs in Beeline)

Table D-7 is referenced by the ETSA/B, FRMA/B, RGEA/B/D and WRCA/B logs.

Table D-7, Bits 0 - 3: Channel Tracking State

State	Description	State	Description
0	L1 Idle	6	L1 Steering
1	L1 Sky search	7	L1 Frequency-lock loop
2	L1 Wide frequency band pull-in	8	L2 Idle
3	L1 Narrow frequency band pull-in	9	L2 P-code alignment
4	L1 Phase-lock loop	10	L2 Search
5	L1 Re-acquisition	11	L2 Phase-lock loop

Higher numbers are reserved for future use

Table D-7, Bits 12-14: Correlator Spacing

State	Description
0	Unknown: this only appears in versions of software previous to x.45, which didn't use this field
1	Standard correlator: spacing = 1 chip
2	Narrow Correlator tracking technology: spacing < 1 chip

Higher numbers are reserved for future use

RINEX Receiver-Independent Exchange Format

The Receiver-Independent Exchange (RINEX) format is a broadly-accepted, receiver-independent format for storing GPS data. It features a non-proprietary ASCII file format that can be used to combine or process data generated by receivers made by different manufacturers. RINEX was originally developed at the Astronomical Institute of the University of Berne. Version 2, containing the latest major changes, appeared in 1990; subsequently, minor refinements were added in 1993. To date, there are three different RINEX file types: observation files, broadcast navigation message files and meteorological data files.

Please see *Rinex Format, Page 57* for further details.

RPSA/B Reference Station Position and Health

This log contains the ECEF XYZ position of the reference station as received through the RTCA Type 7 or RTCM Type 3 message. It also features a time tag, the health status of the reference station, and the station ID. This information is set at the reference station using the FIX POSITION command.

RPSA

Structure:

\$RPSA week seconds X Y Z health stn ID *xx [CR][LF]

Field #	Field type	Data Description	Example
1	\$RPSA	Log header	\$RPSA
2	week	GPS week number	872
3	seconds	GPS time into the week (seconds)	174962.00
4	X 1	ECEF X value (meters)	-1634962.8660
5	Y 1	ECEF y value (meters)	-3664682.4140
6	Z 1	ECEF z value (meters)	4942301.3110
7	health	Reference Station Health	0
8	stn ID	Reference station identification (RTCM: 0 - 1023, or RTCA: 266305 - 15179385)	119
9	*xx	Checksum	*32
10	[CR][LF]	Sentence terminator	[CR][LF]

Note: 1 If (X, Y, Z) = (0,0,0) then a reference station position has not yet been determined.

Example:

\$RPSA,872,174962.00,-1634962.8660,-3664682.4140,4942301.3110,0,119*32[CR][LF]

RPSB

Format: Message ID = 60 Message byte count = 56

Field #	Data	Bytes	Format	Units	Offset
1 (header)	Sync	3	char		0
	Checksum	1	char		3
	Message ID	4	integer		4
	Message byte count	4	integer		8
2	GPS week number	4	integer	weeks	12
3	GPS time into the week	8	double	seconds	16
4	ECEF X value	8	double	meters	24
5	ECEF Y value	8	double	meters	32
6	ECEF Z value	8	double	meters	40
7	Reference station health	4	integer		48
8	Reference station identification (RTCM: 0 - 1023, or RTCA: 266305 - 15179385)	4	integer		52

RTCA Standard Logs

The RTCA (Radio Technical Commission for Aviation Services) Standard is being designed to support Differential Global Navigation Satellite System (DGNSS) Special Category I (SCAT-I) precision instrument approaches. The RTCA Standard is in a preliminary state. NovAtel's current support for this Standard is based on "Minimum Aviation System Performance Standards DGNSS Instrument Approach System: Special Category I (SCAT-I)" dated August 27, 1993 (RTCA/DO-217).

See *RTCA Format Messages, Page 46* for more detailed information on RTCA standard logs.

RTCM Standard Logs

The Radio Technical Commission for Maritime Services (RTCM) was established to facilitate the establishment of various radio navigation standards, which includes recommended GPS differential standard formats.

The standards recommended by the Radio Technical Commission for Maritime Services Special Committee 104, Differential GPS Service (RTCM SC-104, Washington, D.C.), have been adopted by NovAtel for implementation into the GPSCard. Because the GPSCard is capable of utilizing RTCM formats, it can easily be integrated into positioning systems around the globe.

See *RTCM Format Messages, Page 48* for more detailed information on RTCM standard logs.

RTKA/B Computed Position - Time Matched RTK

This log represents positions that have been computed from time matched reference and remote observations. There is no reference station extrapolation error on these positions but because they are based on buffered measurements, they lag real time by some amount depending on the latency of the data link. If the remote receiver has not been enabled to accept RTK differential data, or is not actually receiving data leading to a valid solution, this will be reflected by the code shown in field #16 (RTK status) and #17 (position type).

The data in the logs will change only when a reference observation (RTCM Type 59 or the corresponding RTCA Type 7) changes. If the log is being output at a fixed rate and the differential data is interrupted, then the RTKA/B logs will continue to be output at the same rate but the position and time will not change.

A good message trigger for this log is "ONCHANGED". Then, only positions related to unique reference station messages will be produced, and the existence of this log will indicate a successful link to the reference station.

RTKA

Structure:

\$RTKA	week	seconds	#sv	#high	L1L2 #high
lat	lon	hgt	undulation	datum ID	
lat σ	lon σ	hgt σ	soln status	rtk status	
posn type	dyn mode	stn ID	*xx	[CR][LF]	

Field #	Field type	Data Description	Example
1	\$RTKA	Log header	\$RTKA
2	week	GPS week number	872
3	seconds	GPS time into the week (in seconds)	174962.00
4	#sv	Number of matched satellites; may differ from the number in view.	8
5	#high	Number of matched satellites above RTK mask angle; observations from satellites below mask are heavily de-weighted	7
6	L1L2 #high	Number of matched satellites above RTK mask angle with both L1 and L2 available	7
7	lat	Latitude of position in current datum, in decimal fraction format. A negative sign implies South latitude	51.11358039754
8	lon	Longitude of position in current datum, in decimal fraction format. A negative sign implies West longitude	-114.04358003164
9	hgt	Height of position in current datum, in meters above mean sea level	1059.4105
10	undulation	Geoidal separation, in meters, where positive is above ellipsoid and negative is below ellipsoid	-16.2617
11	datum ID	Current datum (see <i>Appendix G, Page 240</i>)	61
12	lat σ	Standard deviation of latitude solution element, in meters	0.0036
13	lon σ	Standard deviation of longitude solution element, in meters	0.0039
14	hgt σ	Standard deviation of height solution element, in meters	0.0066
15	soln status	Solution status (see <i>Table D-1, Page 144</i>)	0
16	rtk status	RTK status (see <i>Tables D-3, D-4, Page 145</i>)	0
17	posn type	Position type (see <i>Table D-2, Page 145</i>)	4
18	dyn mode	Dynamics mode (0= static, 1= kinematic)	0
19	stn ID	Reference station identification (RTCM: 0 - 1023, or RTCA: 266305 - 15179385)	119
20	*xx	Checksum	*33
21	[CR][LF]	Sentence terminator	[CR][LF]

Example:

```
$RTKA,872,174962.00,8,7,7,51.11358039754,-114.04358003164,1059.4105,
-16.2617,61,0.0036,0.0039,0.0066,0,0,4,0,119*33[CR][LF]
```

RTKB

Format:

Message ID = 61 Message byte count = 116

Field #	Data	Bytes	Format	Units	Offset
1 (header)	Sync	3	char		0
	Checksum	1	char		3
	Message ID	4	integer		4
	Message byte count	4	integer		8
2	Week number	4	integer	weeks	12
3	GPS time into the week	8	double	seconds	16
4	Number of matched satellites (00-12)	4	integer		24
5	Number of matched satellites above RTK mask angle	4	integer		28
6	Number of matched satellites above RTK mask angle with both L1 and L2 available	4	integer		32
7	Latitude	8	double	degrees	36
8	Longitude	8	double	degrees	44
9	Height above mean sea level	8	double	meters	52
10	Undulation	8	double	meters	60
11	Datum ID	4	integer		68
12	Standard deviation of latitude	8	double	meters	72
13	Standard deviation of longitude	8	double	meters	80
14	Standard deviation of height	8	double	meters	88
15	Solution status	4	integer		96
16	RTK status	4	integer		100
17	Position type	4	integer		104
18	Dynamics mode	4	integer		108
19	Reference station identification (RTCM: 0 - 1023, or RTCA: 266305 - 15179385)	4	integer		112

RTKOA/B RTK Solution Parameters RTK

This is the “RTK output” log, and it contains miscellaneous information regarding the RTK solution. It is based on the matched update. Note that the length of the log messages will vary depending on the number of matched satellites in the solution, a quantity represented by #sv in the field numbers.

RTKOA

Structure:

\$RTKOA	week	sec	status	#sat	#high	L1L2 #high	#sv
dyn	search	combn	C _{xx}	C _{xv}	C _{xz}	C _{vx}	C _{vy}
C _{zx}	C _{zy}	C _{zz}	Δx	Δy	Δz	C _{Δx}	C _{Δy}
rsrv	rsrv	ref id	#res				
sat id	amb	res					
:							
sat id	amb	res					
*xx	[CR][LF]						

Field#	Field type	Data Description	Example
1	\$RTKOA	Log header	\$RTKOA
2	week	GPS week number	929
3	sec	GPS time into the week (in seconds)	237639.00
4	status	RTK status (see <i>Table D-10, Page 211</i>)	1
5	#sat	Total number of matched satellites available to both receivers	8
6	#high	Number of matched satellites above RTK mask angle; observations from satellites below mask are heavily deweighted	8
7	L1L2 #high	Number of matched satellites above RTK mask angle with both L1 and L2 available	8
8	#sv	Number of matched satellites in solution; may differ from the number in view.	8
9	dyn	Dynamics mode (0=static, 1=kinematic)	0
10	search	Searcher status (see <i>Table D-9, Page 211</i>).	4
11	combn	Number of possible lane combinations remaining	1
12-20	[C]	The C _{xx} , C _{xy} , C _{xz} , C _{yx} , C _{yy} , C _{yz} , C _{zx} , C _{zy} , and C _{zz} components, in (meters) ² , of the ECEF position covariance matrix (3 x 3)	0.000006136,0.000003797,-0.000003287, 0.000003797,0.000013211,-0.000007043, -0.000006287,-0.000007043,0.000018575
21-23	Δx,Δy,Δz	ECEF x,y,z of baseline from float solution in meters	3.2209,-3.0537,-1.2024
24-26	C _{Δx} ,C _{Δy} ,C _{Δz}	x,y,z standard deviations of float solution baseline in meters	0.0183,0.0138,0.0124
27	rsrv	Reserved for future use	0
28	rsrv	Reserved for future use	0.0000
29	ref id	Reference PRN	1
30	#res	Number of residual sets to follow	7
31	sat id	PRN number	21
32	amb	Ambiguity type (see <i>Table D-8, Page 211</i>)	6
33	res	Residual in metres	-0.001199
...	...	Next PRN number, amb, res	
...	
...	...	Last PRN number, amb, res	
variable	*xx	Checksum	*60
variable	[CR][LF]	Sentence terminator	[CR][LF]

Example:

```
$RTKOA,929,237639.00,1,8,8,8,8,0,4,1,0.000006136,0.000003797,
-0.000006287,0.000003797,0.000013211,-0.000007043,-0.000006287,
-0.000007043,0.000018575,3.2209,-3.0537,
-1.2024,0.0183,0.0138,0.0124,0,0.0000,1,7,
21,6,-0.001199,23,6,0.005461,31,6,0.009608,9,6,0.001963,
15,6,0.000208,29,6,-0.005643,25,6,-0.004366*60[CR][LF]
```

RTKOB

Format: Message ID = 62

Message byte count = 196 + (#res)*16

Field #	Data	Bytes	Format	Units	Offset
1 (header)	Sync	3	char		0
	Checksum	1	char		3
	Message ID	4	integer		4
	Message byte count	4	integer		8
2	GPS week number	4	integer	weeks	12
3	GPS time into the week	8	double	s	16
4	RTK status (see <i>Table D-10, Page 211</i>)	4	integer		24
5	Total number of matched satellites available to both receivers.	4	integer		28
6	Number of matched satellites above RTK mask angle	4	integer		32
7	Number of matched satellites above RTK mask angle with both L1 and L2 available	4	integer		36
8	Number of matched satellites in solution	4	integer		40
9	Dynamics mode (0=static, 1=kinematic)	4	integer		44
10	Searcher status (see <i>Table D-9, Page 211</i>).	4	integer		48
11	Number of possible lane combinations remaining	4	integer		52
12-20	Position covariance matrix	72	double	m ²	56
21-23	Baseline in ECEF x,y,z from float filter	24	double	m	128
24-26	Standard deviations of x,y,z from float filter	24	double	m	152
27	Reserved for future use	4	integer		176
28	Reserved for future use	8	double		180
29	Reference PRN	4	integer		188
30	Number of residual sets to follow	4	integer		192
31	PRN number	4	integer		196
32	Ambiguity type (see <i>Table D-8, Page 211</i>)	4	integer		
33	Residual	8	double	m	
34	Next PRN offset = 196 + (#res)*16				

Table D-8 Ambiguity Types

Ambiguity Type	Definition
0	L1 only floating
1	Wide lane fixed integer
2	Reserved
3	Narrow lane floating
4	Iono-free floating
5	Reserved
6	Narrow lane fixed integer
7	Iono-free fixed discrete
8	L1 only fixed integer
9	Reserved
10	Undefined type

Higher numbers are reserved for future use

Table D-9 Searcher Status

Searcher Status	Definition
0	No search requested
1	Searcher buffering measurements
2	Currently searching
3	Search decision made
4	Hand-off to L1 and L2 complete

Higher numbers are reserved for future use

Table D-10 RTK Status

RTK Status	Definition
1	Good narrowlane solution
2	Good widelane solution
4	Good L1/L2 converged float solution
8	Good L1/L2 unconverged float solution
16	Good L1 converged solution
32	Good L1 unconverged solution
64	Reserved for future use
128	Insufficient observations
256	Variance exceeds limit
512	Residuals exceed limit
1024	Delta position too large
2048	Negative variance
4096	Undefined
8192	RTK initialize

RVSA/B Receiver Status

This log conveys various status parameters of the receiver system. If the system is a multiple-GPSCard unit with a master card, certain parameters are repeated for each individual GPSCard. If the system is composed of only one GPSCard, then only the parameters for that unit are listed. Together, the RVSA/B and VERA/B logs supersede the RCSA/B logs.

Note that the number of satellite channels (the number of satellites the receiver is capable of tracking) is not necessarily the same as the number of signal channels. This is because one L1/L2 satellite channel requires two signal channels. Therefore the 12-channel MiLLennium GPSCard will report 24 signal channels in this field. This number represents the maximum number of channels reporting information in logs such as ETSA/B and RGEA/B/D.

RVSA

Structure:

\$RVSA	week	seconds	sat_chan	sig_chan	num	reserve
idle	status					
:						
idle	status					
*xx	[CR][LF]					

Field #	Field type	Data Description	Example
1	\$RVSA	Log header	\$RVSA
2	week	GPS week number	847
3	seconds	GPS seconds into the week.	318923.00
4	sat_chan	Number of satellite channels	12
5	sig_chan	Number of signal channels	24
6	num	Number of cards	1
7	reserve	Reserved field	
8	idle	First GPSCard: CPU idle time (percent)	16.00
9	status	First GPSCard: Self-test status (see <i>Table D-5, Page 198</i>)	000B00FF
...	...	Next GPSCard: CPU idle time & self-test status	
...	
...	...	Last GPSCard: CPU idle time & self-test status	
variable	*xx	Checksum	*42
variable	[CR][LF]	Sentence terminator	[CR][LF]

Example:

```
$RVSA,847,318923.00,12,24,1,,16.00,000B00FF*42[CR][LF]
```

RVSB

Format: Message ID = 56 Message byte count = 28 + (8 x number of cards)

Field #	Data	Bytes	Format	Units	Offset
1 (header)	Sync	3	char		0
	Checksum	1	char		3
	Message ID	4	integer		4
	Message byte count	4	integer		8
2	Week number	4	integer	weeks	12
3	Seconds of week	8	double	seconds	16
4	Number of satellite channels	1	char		24
5	Number of signal channels	1	char		25
6	Number of cards	1	char		26
7	Reserved	1	byte		27
8	CPU idle time, percent	4	float		28
9	Self-test status	4	integer		32
8 & 9 are repeated for each card	Next Card offset = 28 + (8 x card number)				

NOTE: For Field 9, self-test bits 2, 3, 4, 6, & 7 are set only once (when the GPSCard is first powered up). All other bits are set by internal test processes each time the RVSB log is output.

SATA/B Satellite Specific Data

This log provides satellite specific data for satellites actually being tracked. The record length is variable and depends on the number of satellites.

Each satellite being tracked has a reject code indicating whether it is used in the solution, or the reason for its rejection from the solution. The reject value of 0 indicates the observation is being used in the position solution. Values of 1 through 11 indicate the observation has been rejected for the reasons specified in *Table D-11*. A range reject code of 8 only occurs when operating in differential mode and an interruption of corrections has occurred or the DGPSTIMEOUT has been exceeded.

SATA

Structure:

\$SATA	week	seconds	sol status	# obs
prn	azimuth	elevation	residual	reject code
:				
prn	azimuth	elevation	residual	reject code
*xx	[CR][LF]			

Field #	Field type	Data Description	Example
1	\$SATA	Log header	\$SATA
2	week	GPS week number	637
3	seconds	GPS seconds into the week	513902.00
4	sol status	Solution status as listed in <i>Table D-1</i>	0
5	# obs	Number of satellite observations with information to follow:	7
6	prn	Satellite PRN number (1-32)	18
7	azimuth	Satellite azimuth from user position with respect to True North, in degrees	168.92
8	elevation	Satellite elevation from user position with respect to the horizon, in degrees	5.52
9	residual	Satellite range residual from position solution for each satellite, in metres	9.582
10	reject code	Indicates that the range is being used in the solution (code 0) or that it was rejected (code 1-11), as shown in <i>Table D-11</i>	0
...	...	Next PRN number, azimuth, elevation, residual, reject code	
...	
...	...	Last PRN number, azimuth, elevation, residual, reject code	
variable	*xx	Checksum	*1F
variable	[CR][LF]	Sentence terminator	[CR][LF]

Example:

```
$SATA,637,513902.00,0,7,18,168.92,5.52,9.582,0,6,308.12,55.48,0.737,0,
15,110.36,5.87,16.010,0,11,49.63,40.29,-0.391,0,
2,250.05,58.89,-12.153,0,16,258.55,8.19,-20.237,0,
19,118.10,49.46,-14.803,0*1F[CR][LF]
```

SATB

Format: Message ID =12 Message byte count = 32 + (obs*32)

Field #	Data	Bytes	Format	Units	Offset
1 (header)	Sync	3	char		0
	Checksum	1	char		3
	Message ID	4	integer		4
	Message byte count	4	integer		8
2	Week number	4	integer	weeks	12
3	Seconds of week	8	double	seconds	16
4	Solution status	4	integer		24
5	Number of observations (obs)	4	integer		28
6	PRN	4	integer		32
7	Azimuth	8	double	degrees	36
8	Elevation	8	double	degrees	44
9	Residual	8	double	metres	52
10	Reject Code	4	integer		60
11...	Next PRN offset = 32 + (obs*32) where obs varies from 0 to (obs-1)				

Table D-11 GPSCard Range Reject Codes

Value	Description
0	Observations are good
1	Bad satellite health is indicated by ephemeris data
2	Old ephemeris due to data not being updated during last 3 hours
3	Eccentric anomaly error during computation of the satellite's position
4	True anomaly error during computation of the satellite's position
5	Satellite coordinate error during computation of the satellite's position
6	Elevation error due to the satellite being below the cutoff angle
7	Misclosure too large due to excessive gap between estimated and actual positions
8	No differential correction is available for this particular satellite
9	Ephemeris data for this satellite has not yet been received
10	Invalid IODE due to mismatch between differential stations
11	Locked Out: satellite is excluded by user (LOCKOUT command)
12	Low Power: satellite rejected due to low signal/noise ratio
13	L2 measurements are not currently used in the filter



SBTA/B Satellite Broadcast Data: Raw Symbols

This message contains the satellite broadcast data in raw symbols before FEC decoding or any other processing. An individual message is sent for each PRN being tracked. For a given satellite, the message number increments by one each time a new message is generated. This data matches the RBTA/B data if the message numbers are equal. The data must be logged with the 'onnew' trigger activated to prevent loss of data.

SBTA

Structure:

\$SBTA	week	seconds	prn	cstatus	message #	# of symbols
raw symbols	*xx	[CR][LF]				

Field #	Field type	Data Description	Example
1	\$SBTA	Log header	\$SBTA
2	week	GPS week number	883
3	seconds	GPS seconds into the week	413908.000
4	prn	PRN of satellite from which data originated	120
5	cstatus	Channel Tracking Status	80812F14
6	message #	Message sequence number	119300
7	# of symbols	Number of symbols transmitted in the message. At present, always equals 256 symbols.	256
8	raw symbols	256 symbols compressed into 128 bytes, i.e. 4 bits/symbol. Hence, 256 hex characters are output. If FEC decoding is enabled, soft symbols are output with values ranging from E to 3 where 3's represent binary 1 and E's represent binary 0 output.	EE33EEEE3333E33EE33EEEE33 333E33EE33EEEE3333E33EE33E EEE33333EEEE3333EEE33E33E3 EE33EEEE33EEEE33EE3E3EEEEEE EEEEEEEE3333EEE33EEEE33E E33EE3E3EE3EE33EEE33E333EE 3333E3E3333E33E3333EEEE333 EE3E3333EE3EE3EE33EE3EE3EE 3E33E33E3EEEE33333E3333E33E3 E333E3E33333E3EEE3E3E
9	*xx	Checksum	*4C
10	[CR][LF]	Sentence terminator	[CR][LF]

SBTB

Format: Message ID = 53 Message byte count = 168

Field #	Data	Bytes	Format	Units	Offset
1 (header)	Sync	3	char		0
	Checksum	1	char		3
	Message ID	4	integer		4
	Message byte count	4	integer	bytes	8
2	Week number	4	integer	weeks	12
3	Seconds of week	8	double	seconds	16
4	PRN number	4	integer	1-999	24
5	Channel Status	4	integer	n/a	28
6	Message #	4	integer	n/a	32
7	# of Symbols	4	integer	n/a	36
8	Raw Symbols	128	char	n/a	40

SPHA/B Speed and Direction Over Ground

This log provides the actual speed and direction of motion of the GPSCard antenna over ground, at the time of measurement, and is updated up to 10 times per second. It should be noted that the GPSCard does not determine the direction a vessel, craft, or vehicle is pointed (heading), but rather the direction of motion of the GPS antenna relative to ground.

SPHA

Structure:

\$SPHA	week	seconds	hor spd	trk gnd
vert spd	sol status	*xx	[CR][LF]	

Field #	Field type	Data Description	Example
1	\$SPHA	Log header	\$SPHA
2	week	GPS week number	640
3	seconds	GPS seconds into the week	333111.00
4	hor spd	Horizontal speed over ground, in meters per second	0.438
5	trk gnd	Actual direction of motion over ground (track over ground) with respect to True North, in degrees	325.034
6	vert spd	Vertical speed, in metres per second, where positive values indicate increasing altitude (up) and negative values indicate decreasing altitude (down)	2.141
7	sol status	Solution status as listed in <i>Table D-1</i>	0
8	*xx	Checksum	*02
9	[CR][LF]	Sentence terminator	[CR][LF]

Example:

```
$SPHA,640,333111.00,0.438,325.034,2.141,0*02[CR][LF]
```

SPHB

Format: Message ID = 06 Message byte count = 52

Field #	Data	Bytes	Format	Units	Offset
1 (header)	Sync	3	char		0
	Checksum	1	char		3
	Message ID	4	integer		4
	Message byte count	4	integer		8
2	Week number	4	integer	weeks	12
3	Seconds of week	8	double	seconds	16
4	Horizontal speed	8	double	metres per second	24
5	Track over ground (TOG)	8	double	degrees	32
6	Vertical speed	8	double	metres per second	40
7	Solution status	4	integer		48



SVDA/B SV Position in ECEF XYZ Coordinates with Corrections

When combined with a RGEA/B/D log, this data set contains all of the decoded satellite information necessary to compute the solution: satellite coordinates (ECEF WGS84), satellite clock correction, ionospheric corrections (see the IONOMODEL command on *Page 105*), tropospheric corrections (Hopfield model), decoded differential correction used and range weight standard deviation. The corrections are to be added to the pseudoranges. Only those satellites that are healthy are reported here. Also see *Figure D-2, Page 187*.

SVDA

Structure:

```

$SVDA  week  seconds  rec clk err  # obs
prn  x  y  z  clk corr  ion corr  trop corr  diff corr  rng std
:
prn  x  y  z  clk corr  ion corr  trop corr  diff corr  rng std
*xx  [CR][LF]
    
```

Field #	Field type	Data Description	Example
1	\$SVDA	Log header	\$SVDA
2	week	GPS week number	766
3	seconds	GPS seconds into the week (receiver time, not corrected for clock error, CLOCKADJUST enabled)	143860.00
4	rec clk err	Solved receiver clock error (metres)	-4.062
5	# obs	Number of satellite observations to follow	7
6	prn	Satellite PRN number (1-32)	20
7	x	Satellite x coordinate (metres)	-15044774.225
8	y	Satellite y coordinate (metres)	-9666598.520
9	z	Satellite z coordinate (metres)	19499537.398
10	clk corr	Satellite clock correction (metres)	6676.013
11	ion corr	Ionospheric correction (metres)	-1.657
12	trop corr	Tropospheric correction (metres)	-2.662
13	diff corr	Decoded differential correction used (metres)	16.975
14	rng std	Range weight standard deviation (metres)	0.674
...	...	Next PRN number, x, y, z, clk corr, ion corr, trop corr, diff corr, mg std	
...	
...	...	Last PRN number, x, y, z, clk corr, ion corr, trop corr, diff corr, mg std	
variable	*xx	Checksum	*23
variable	[CR][LF]	Sentence terminator	[CR][LF]

Example:

```

$SVDA,766,143860.00,-4.062,7,
20,-15044774.225,-9666598.520,19499537.398,6676.013,-1.657,-2.662,16.975,0.674
5,-10683387.874,-21566845.644,11221810.349,18322.228,-1.747,-2.819,-8.864,0.790,
6,-20659074.698,-28381.667,16897664619,57962.693,-2.543,4.401,-37.490,1.203,
16,142876.148,-26411452.927,2795075.561,-22644.136,-2.733,-4.904,7.701,1.259,
24,-852160.876,-16138149.057,21257323.813,229594.682,-1.545,-2.451,32.178,0.420,
25,-12349609.643,11102877.199,20644151.935,-4313.339,-3.584,-8.579,
-42.813,1.370,
. . .
4,14209626.440,-9259502.647,20544348.215,12811.399,-2.675,-4.741,-10.778,1.239
*23[CR][LF]
    
```

SVDB

Format: Message ID = 36 Message byte count = 36 +(obs*68)

Field #	Data	Bytes	Format	Units	Offset
1 (header)	Sync	3	char		0
	Checksum	1	char		3
	Message ID	4	integer		4
	Message byte count	4	integer		8
2	Week number	4	integer	weeks	12
3	Time in seconds	8	double	seconds	16
4	Receiver clock error	8	double	metres	24
5	Number of observations to follow (obs)	4	integer		32
6	Satellite PRN number	4	integer		36
7	x coordinate of satellite	8	double	metres	40
8	y coordinate of satellite	8	double	metres	48
9	z coordinate of satellite	8	double	metres	56
10	Satellite clock correction	8	double	metres	64
11	Ionospheric correction	8	double	metres	72
12	Tropospheric correction	8	double	metres	80
13	Decoded differential correction used	8	double	metres	88
14	Range weight standard deviation	8	double	metres	96
15...	Next PRN offset = 36 + (obs*68) where obs varies from 0 to (obs-1)				

TM1A/B Time of 1PPS

This log provides the time of the GPSCard 1PPS, normally high, active low pulse (1 millisecond), where falling edge is reference, in GPS week number and seconds into the week. The TM1A/B log follows a 1PPS pulse. It also includes the receiver clock offset, the standard deviation of the receiver clock offset and clock model status. This log will output at a maximum rate of 1 Hz.

TM1A

Structure:

\$TM1A	week	seconds	offset	offset std
utc offset	cm status	*xx	[CR][LF]	

Field #	Field type	Data Description	Example
1	\$TM1A	Log header	\$TM1A
2	week	GPS week number	794
3	seconds	GPS seconds into the week at the epoch coincident with the 1PPS output strobe (receiver time)	414634.99999996 6
4	offset	Receiver clock offset, in seconds. A positive offset implies that the receiver clock is ahead of GPS Time. To derive GPS time, use the following formula: GPS time = receiver time - (offset)	-0.000000078
5	offset std	Standard deviation of receiver clock offset, in seconds	0.000000021
6	utc offset	This field represents the offset of GPS time from UTC time, computed using almanac parameters. To reconstruct UTC time, algebraically subtract this correction from field 3 above (GPS seconds). UTC time = GPS time + (utc offset)	-9.999999998
7	cm status	Receiver Clock Model Status where 0 is valid and values from -20 to -1 imply that the model is in the process of stabilization	0
8	*xx	Checksum	*57
9	[CR][LF]	Sentence terminator	[CR][LF]

Example:

```
$TM1A,794,414634.999999966,-0.000000078,0.000000021,-9.999999998,0*57[CR][LF]
```

TM1B

Format: Message ID = 03 Message byte count = 52

Field #	Data	Bytes	Format	Units	Offset
1 (header)	Sync	3	char		0
	Checksum	1	char		3
	Message ID	4	integer		4
	Message byte count	4	integer		8
2	Week number	4	integer	weeks	12
3	Seconds of week	8	double	seconds	16
4	Clock offset	8	double	seconds	24
5	Stddev clock offset	8	double	seconds	32
6	UTC offset	8	double	seconds	40
7	Clock model status	4	integer		48

VERA/B Receiver Hardware and Software Version Numbers

This log contains the current hardware type and software version number for the GPSCard. Together with the RVSA/B log, it supersedes the RCSA/B log.

VERA

Structure:

\$VERA week seconds version *xx [CR][LF]

Field #	Field type	Data Description	Example
1	\$VERA	Log header	\$VERA
2	week	GPS week number	853
3	seconds	GPS seconds into the week.	401364.50
4	version	GPSCard hardware type and software version number	OEM-3MILLENSTD CGL96170069 HW 3-1 SW 4.42/2.03 May 14/96
5	*xx	Checksum	*2B
6	[CR][LF]	Sentence terminator	[CR][LF]

Example:

```
$VERA,853,401364.50,OEM-3 MILLENSTD CGL96170069 HW 3-1 SW 4.42/2.03 May 14/
96*2B[CR][LF]
```

VERB

Format: Message ID = 58 Message byte count = 104

Field #	Data	Bytes	Format	Units	Offset
1 (header)	Sync	3	char		0
	Checksum	1	char		3
	Message ID	4	integer		4
	Message byte count	4	integer		8
2	Week number	4	integer	weeks	12
3	Time into week	8	double	s	16
4	Version numbers	80	char		24

VLHA/B Velocity, Latency, and Direction Over Ground

This log is similar to the SPHA/B message. As in the SPHA/B messages the actual speed and direction of the GPSCard antenna over ground is provided. The VLHA/B differs in that it provides a measure of the latency in the velocity time tag and a new velocity status word which gives the user more velocity quality information. The velocity status indicates varying degrees of velocity quality. To ensure healthy velocity, the position sol-status must also be checked. If the sol-status is non-zero, the velocity will likely be invalid. Also, it includes the age of the differential corrections used in the velocity computation. It should be noted that the GPSCard does not determine the direction a vessel, craft, or vehicle is pointed (heading), but rather the direction of motion of the GPS antenna relative to ground.

VLHA

Structure:

\$VLHA	week	seconds	latency	age	hor spd	trk gnd
vert spd	sol status	vel status	*xx	[CR][LF]		

Field #	Field type	Data Description	Example
1	\$VLHA	Log header	\$VLHA
2	week	GPS week number	640
3	seconds	GPS seconds into the week	333111.00
4	latency ¹	A measure of the latency in the velocity time tag in seconds. It should be subtracted from the time to give improved results.	0.250
5	age	Age of Differential GPS data in seconds	3.500
6	hor spd	Horizontal speed over ground, in metres per second	0.438
7	trk gnd	Actual direction of motion over ground (track over ground) with respect to True North, in degrees	325.034
8	vert spd	Vertical speed, in metres per second, where positive values indicate increasing altitude (up) and negative values indicate decreasing altitude (down)	2.141
9	sol status	Solution status as listed in <i>Table D-1</i>	0
10	vel status	Velocity status as listed in <i>Table D-12</i>	0
11	*xx	Checksum	*02
12	[CR][LF]	Sentence terminator	[CR][LF]

1 Velocity Latency

The velocity is computed using Doppler values derived from differences in consecutive carrier-phase measurements. As such, it is an average velocity based on the time difference between successive position computations and not an instantaneous velocity at the SPHA/B time tag. Under normal operation the position's coordinates are updated at a rate of two times per second. The velocity latency compared to this time tag will normally be 1/2 the time between position fixes. The default filter rate is 2 Hz, so this latency is typically 0.25 second, but if, for example, the POSA records were to be logged on time 0.2, then the velocity latency would be one half of 0.2, or 0.1 second. The latency can be reduced further by the user requesting the POSA/B, the SPHA/B, or the VLHA/B messages at rates higher than 2 Hz. For example, a rate of 10 Hz will reduce the velocity latency to 1/20 of a second. For integration purposes, the velocity latency should be applied to the record time tag.

Example:

```
$VLHA,640,333111.00,0.250,3.500,0.438,325.034,2.141,0,0*02[CR][LF]
```

VLHB

Format: Message ID = 34 Message byte count = 72

Field #	Data	Bytes	Format	Units	Offset
1 (header)	Sync	3	char		0
	Checksum	1	char		3
	Message ID	4	integer		4
	Message byte count	4	integer		8
2	Week number	4	integer	weeks	12
3	Seconds of week	8	double	seconds	16
4	Latency	8	double	metres per second	24
5	Age	8	double	seconds	32
6	Horizontal speed	8	double	metres per second	40
7	Track over ground (TOG)	8	double	degrees	48
8	Vertical speed	8	double	metres per second	56
9	Solution status	4	integer		64
10	Velocity status	4	integer		68

Table D-12 GPSCard Velocity Status

Value	Description
0	Velocity computed from differentially corrected carrier phase data
1	Velocity computed from differentially corrected Doppler data
2	Old velocity from differentially corrected phase or Doppler (higher latency)
3	Velocity from single point computations
4	Old velocity from single point computations (higher latency)
5	Invalid velocity

Higher values reserved for future use

WALA/B WAAS Almanac WAAS

Structure:

\$WALA	week	seconds	WAAS week	WAAS seconds
prn	data ID	health		
pos X	pos Y	pos Z		
vel X	vel Y	vel Z		

Field #	Field type	Data Description	Example
1	\$WALA	Log header	\$WALA
2	week	GPS week number	981
3	seconds	GPS seconds into the week	447490.88
4	WAAS week	WAAS week number	981
5	WAAS seconds	WAAS seconds into the week at time of application	447360
6	prn	WAAS GEO satellite PRN number	122
7	data ID	Version of WAAS signal specification, see <i>Table D-14</i>	0
8	health	Health and status of the WAAS GEO satellite, see <i>Table D-13</i>	0
9	pos X	Position x coordinate of WAAS GEO satellite at WAAS seconds (Field #5)	2.5789400E+007
10	pos Y	Position y coordinate of WAAS GEO satellite at WAAS seconds (Field #5)	-3.5479600E+007
11	pos Z	Position z coordinate of WAAS GEO satellite at WAAS seconds (Field #5)	2.60000000E+004
12	vel X	Velocity x coordinate of WAAS GEO satellite	0.00000000E+000
13	vel Y	Velocity y coordinate of WAAS GEO satellite	0.00000000E+000
14	vel Z	Velocity z coordinate of WAAS GEO satellite	0.00000000E+000
15	*xx	Checksum	*32
16	[CR][LF]	Sentence terminator	[CR] [LF]

*Example:

```
$WALA,981,447490.88,981,447360,122,0,0,2.57894000E+007,-3.5479600E+007,
2.60000000E+004,0.00000000E+000,0.00000000E+000,0.00000000E+000*32 [CR] [LF]
```

WALB

Format: Message ID = 81 Message byte count = 92

Field #	Data	Bytes	Format	Units	Offset
1 (header)	Sync	3	char		0
	Checksum	1	char		3
	Message ID	4	integer		4
	Message byte count	4	integer		8
2	Week number	4	ulong	weeks	12
3	Seconds of week	8	double	seconds	16
4	WAAS week number	4	integer	weeks	24
5	WAAS seconds of week	4	integer	seconds	28
6	WAAS satellite PRN number	4	integer		32
7	WAAS signal specification version	4	integer		36
8	WAAS satellite health	4	integer		40
9	Position x coordinate of WAAS satellite	8	double	meters	44
10	Position y coordinate of WAAS satellite	8	double	meters	52
11	Position z coordinate of WAAS satellite	8	double	meters	60
12	Velocity x coordinate of WAAS satellite	8	double	m/s	68
13	Velocity y coordinate of WAAS satellite	8	double	m/s	76
14	Velocity z coordinate of WAAS satellite	8	double	m/s	84

Table D-13 Health and Status Bits

Bit Number*	Description	Range Values
0	Ranging	0 = On 1 = Off
1	Corrections	0 = On 1 = Off
2	Broadcast integrity	0 = On 1 = Off
3	Reserved	-
4-7	Service Provider ID	-

*Note: Read the binary output from the Health field from right to left. The first bit to the right, the least significant bit, is bit 0 and so on to the left.

Table D-14 Data ID Type

Data ID	Type (Service Provider)
0	WAAS (Wide Area Augmentation System)
1	EGNOS (European Geostationary Navigation Overlay Service)
2	MSAS (Multi-Functional Transport Satellite (MTSAT) based Augmentation System)
3-15	Reserved



WEPA/B WAAS Ephemeris WAAS

The WEPA/B logs contain the WAAS satellite's latest computed position, velocity and acceleration in ECEF coordinates. See *Figure D-2 The WGS84 ECEF Coordinate System on Page 187* for a pictorial representation and definition of the ECEF coordinate system.

NOTE: These quantities are always referenced to the WGS-84 ellipsoid, regardless of the use of the DATUM or USERDATUM commands.

WEPA

Structure:

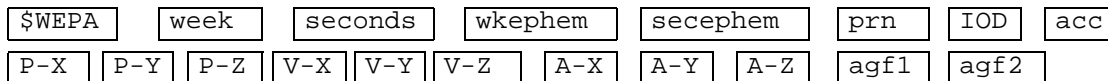

Field #	Field type	Data Description	Example
1	\$WEPA	Log header	\$WEPA
2	week	GPS week number	35
3	seconds	GPS time of week (s)	417865.00
4	wkephem	GPS week number of ephemeris data	35
5	secephem	GPS seconds into the week at time of ephemeris data.	417728
6	prn	PRN of WAAS satellite	122
7	IOD	Issue of Data (IOD) of WAAS ephemeris (0-256)	147
8	accuracy	Accuracy of satellite	15
9	P-x	Satellite position's X-coordinate (m)	2.4798730960000039E+007
10	P-y	Satellite position's Y-coordinate (m)	-3.4084460000000005E+007
11	P-z	Satellite position's Z-coordinate (m)	5.29800000000000053E+003
12	V-x	Satellite velocity vector along X-axis (m/s)	2.4256250000000005E+000
13	V-y	Satellite velocity vector along Y-axis (m/s)	2.5000000000000000E-003
14	V-z	Satellite velocity vector along Z-axis (m/s)	-1.4880000000000000E+000
15	A-x	Satellite acceleration vector along X-axis (m/s ²)	-1.2500000000000000E-004
16	A-y	Satellite acceleration vector along Y-axis (m/s ²)	-1.7500000000000000E-004
17	A-z	Satellite acceleration vector along Z-axis (m/s ²)	0.0000000000000000E+000
18	agf0	Clock corrections of WAAS satellite at time of ephemeris data	1.8626451492309570E-009
19	agf1	Clock corrections of WAAS satellite at time of ephemeris data	9.0949470177292823E-013
20	*xx	Checksum	*6D
21	[CR][LF]	Sentence terminator	[CR][LF]

Example:

```
$WEPA, 35, 417865.00, 35, 417728, 122, 147, 15, 2.4798730960000039E+007,
-3.4084460000000005E+007, 5.29800000000000053E+003,
2.4256250000000005E+000, 2.5000000000000000E-003,
-1.4880000000000000E+000, -1.2500000000000000E-004,
-1.7500000000000000E-004, 0.0000000000000000E+000,
1.8626451492309570E-009, 9.0949470177292823E-013*6D[CR][LF]
```

WEPB

Format: Message ID = 80 Message byte count = 128

Field #	Field Type	Bytes	Format	Units	Offset
1 (header)	Sync	3	char		0
	Checksum	1	char		3
	Message ID	4	integer		4
	Message byte count	4	integer		8
2	GPS week number	4	ulong	weeks	12
3	GPS time of week	8	double	seconds	16
4	GPS week number of ephemeris data	4	long	weeks	24
5	GPS seconds into the week at time of ephemeris data.	4	long	seconds	28
6	PRN of WAAS satellite	4	long		32
7	Issue of Data (IOD) of WAAS ephemeris	4	long		36
8	Accuracy of satellite	4	long		40
9	Satellite position's X-coordinate (m)	4	long	m	44
10	Satellite position's Y-coordinate (m)	8	double	m	48
11	Satellite position's Z-coordinate (m)	8	double	m	56
12	Satellite velocity vector along X-axis (m/s)	8	double	m/s	64
13	Satellite velocity vector along Y-axis (m/s)	8	double	m/s	72
14	Satellite velocity vector along Z-axis (m/s)	8	double	m/s	80
15	Satellite acceleration vector along X-axis (m/s ²)	8	double	m/s ²	88
16	Satellite acceleration vector along Y-axis (m/s ²)	8	double	m/s ²	96
17	Satellite acceleration vector along Z-axis (m/s ²)	8	double	m/s ²	104
18	Clock corrections of WAAS satellite at time of ephemeris data	8	double	seconds	112
19	Clock corrections of WAAS satellite at time of ephemeris data	8	double	seconds	120

WRCA/B Wide Band Range Correction (Grouped Format)

This message contains the wide band range correction data. A correction is generated for each PRN being tracked and these group together into a single log. Internally, the correction for each satellite is updated asynchronously at a 1 Hz rate. Therefore, logging this message at a rate higher than 1 Hz will result in duplicate data being output. Each range correction is statistically independent and is derived from the previous 1 second of data.

WRCA

Structure:

```

$WRCA  week  seconds  # obs
prn    ch-tr-status  tr-bandwidth  wide band correction
:
prn    ch-tr-status  tr-bandwidth  wide band correction
*xx    [CR][LF]

```

Field #	Field type	Data Description	Example
1	\$WRCA	Log header	\$WRCA
2	week	GPS week number	637
3	seconds	GPS seconds into the week	513902.00
4	# obs	Number of satellite observations with information to follow:	7
5	prn	Satellite PRN number	18
6	ch-tr-status	Channel Tracking Status: Hexadecimal number indicating phase lock, channel number and channel tracking state as shown in <i>Table D-7</i> .	E04
7	tr-bandwidth	DLL tracking loop bandwidth in Hz	0.050
8	wide band correction	Wide band range correction in metres	1.323
...	...	Next PRN number, ch-tr-status, tr-bandwidth, wide band correction	
...	
...	...	Last PRN number, ch-tr-status, tr-bandwidth, wide band correction	
variable	*xx	Checksum	*1F
variable	[CR][LF]	Sentence terminator	[CR][LF]

WRCB

Format: Message ID = 67 Message byte count = 28 + (obs*16)

Field #	Data	Bytes	Format	Units	Offset
1 (header)	Sync	3	char		0
	Checksum	1	char		3
	Message ID	4	integer		4
	Message byte count	4	integer	bytes	8
2	Week number	4	integer	weeks	12
3	Seconds of week	8	double	seconds	16
4	Number of observations (obs)	4	integer		24
5	PRN	4	integer		28
6	Channel tracking status	4	-	-	32
7	DLL tracking loop bandwidth	4	float	Hz	36
8	Wide Band Range Correction	4	float	metres	40
9...	Next PRN offset = 28 + (obs*16)				

WUTCA/B UTC Time Parameters WAAS

This log outputs UTC time parameters and two GLONASS specific fields.

WUTCA

Structure:

\$WUTCA	week	seconds	pct	plot	data-ref	wk #-utc	wk #-lset
d-time	lsop	day #-lset	ustand	glo-ind	reserved	*xx	[CR][LF]

Field #	Field type	Data Description	Example
1	\$WUTCA	Log header	\$WUTCA
2	week	GPS week number	35
3	seconds	GPS time of the week (s)	417865.00
4	pct	Polynomial constant term, seconds	-2.235174179077148E-008
5	p1ot	Polynomial 1st order term, seconds/second	-1.243449787580175E-014
6	data-ref	UTC data reference time, seconds	32768
7	wk #-utc	Week number of UTC reference, weeks	745
8	wk #-lset	Week number for leap sec effect time, weeks	755
9	d-time	Delta time due to leap sec, seconds	9
10	lsop	For use when leap sec on past, seconds	10
11	day #-lset	Day number for leap sec effect time, days	5
12	ustand	UTC standard, see <i>Table D-15 UTC Standard Identifier on Page 230</i>	2
13	glo-ind	Glonass indicator 0 = GLONASS time is not available 1 = GLONASS time is available	0
14	reserved	Reserved for future use	
15	*xx	Checksum	*24
16	[CR][LF]	Sentence terminator	[CR][LF]

Example:

```
$WUTCA, 35, 417865.00, -2.235174179077148E-008, -1.243449787580175E-014,
32768, 745, 755, 9, 10, 5, 2, 0, 0*24 [CR][LF]
```

WUTCB

Message ID = 82

Message byte count = 82

Field #	Field Type	Bytes	Format	Units	Offset
1 (header)	Sync	3	char		0
	Checksum	1	char		3
	Message ID	4	integer		4
	Message byte count	4	integer		8
2	GPS week number	4	ulong	weeks	12
3	GPS time of the week	8	double	seconds	16
4	Polynomial constant term	8	double	seconds	24
5	Polynomial 1st order term	8	double	seconds/second	32
6	UTC data reference time	4	integer	seconds	40
7	Week number UTC reference	4	integer	weeks	44
8	Week number for leap sec effect time	4	integer	weeks	48
9	Delta time due to leap sec	4	integer	seconds	52
10	For use when leap sec on past	4	integer	seconds	56
11	Day number for leap sec effect time	4	integer	days	60
12	UTC standard, see the table below	4	ulong		64
13	GLONASS indicator 0 = GLONASS time is not available 1 = GLONASS time is available	4	ulong		68
14	Reserved for future use	10	uchar		72

Table D-15 UTC Standard Identifier

UTC Identifier	UTC Standard
0	UTC as operated by the Communications Research Laboratory (CRL), Tokyo, Japan
1	UTC as operated by the National Institute of Standards and Technology (NIST)
2	UTC as operated by the U.S. Naval Observatory (USNO)
3	UTC as operated by the International Bureau of Weights and Measures (BIPM)
4	UTC as operated by the European Laboratory (to be determined)
5 to 6	Reserved for future definition
7	UTC not provided

E COMPARISON OF RT-2 AND RT-20

E.1 RT-2 & RT-20 PERFORMANCE

RT-2 and RT-20 are real-time kinematic software products developed by NovAtel. They can only be used in conjunction with NovAtel GPS receivers. A quick comparison of RT-2 and RT-20 is shown in *Table E-1*:

Table E-1 Comparison of RT-2 and RT-20

	RT-2	RT-20
GPS Frequencies Utilized	L1 & L2	L1
Nominal Accuracy	2 cm (CEP)	20 cm (CEP)
Lane Searching	Wide lane and narrow lane	None

NovAtel’s RTK software algorithms utilize both carrier and code phase measurements; thus, the solutions are robust, reliable, accurate and rapid. While both RT-20 and RT-2 operate along similar principles, RT-2 achieves its extra accuracy and precision due to its being able to utilize dual-frequency measurements. Dual-frequency GPS receivers have two main advantages over their single-frequency counterparts when running RTK software:

1. resolution of cycle ambiguity is possible due to the use of wide lane searching
2. longer baselines are possible due to the removal of ionospheric errors

Depending on the transmitting and receiving receivers, various levels of accuracy can be obtained. Please refer to the particular accuracy as shown in *Table E-2*.

Table E-2 RTK Messages Vs. Accuracy

Transmitting (Reference)	Receiving (Remote)	Accuracy Expected
GPSCard transmitting RTCA (i.e. RTCAOBS and RTCAREF)	RT-2 receiver	2 centimetre CEP
	RT-20 receiver	20 centimetre CEP
GPSCard transmitting RTCM type 3 and 59	RT-2 receiver	20 centimetre CEP
	RT-20 receiver	20 centimetre CEP
GPSCard transmitting RTCM or RTCA type 1	RT-2 receiver	1 metre SEP
	RT-20 receiver	1 metre SEP
Transmitting RTCM type 18 and 19 with type 3	RT-2 receiver	2 centimetre CEP
	RT-20 receiver	20 centimetre CEP
Transmitting CMR (i.e. CMROBS and CMRREF)	RT-2 receiver	2 centimetre CEP
	RT-20 receiver	20 centimetre CEP

RT-2 Performance

The RT-2 software provides the accuracies shown in *Table E-3 & Figure E-1* (static mode) and *Table E-4 & Figure E-2* (kinematic mode) for “typical” multipath, ionospheric, tropospheric, and ephemeris errors, where “typical” is described as follows:

- A typical multipath environment would provide no carrier-phase double-difference multipath errors greater than 2 cm or pseudorange double-difference multipath errors greater than 2 m on satellites at 11° elevation or greater. For environments where there is greater multipath, please consult NovAtel Customer Service.
- Typical unmodeled ionospheric, tropospheric and ephemeris errors must be within 2σ of their average values, at a given elevation angle and baseline length. It is assumed that the tropospheric correction is computed with standard atmospheric parameters. All performance specifications assume that at least 6 satellites above the mask angle (varies between 11 and 14 degrees) are being tracked on both L1 and L2.

In *Tables E-3* and *E-4*, accuracy values refer to horizontal RMS error, and are based on matched positions. There are no data delays for a matched log and therefore no need to add anything. The level of position accuracy at any time will be reflected in the standard deviations output with the position.

Table E-3 RT-2 Performance: Static Mode

Baseline length	Time since L2 lock-on with at least 6 satellites above mask angle	Horizontal accuracy at the stated time	Runs meeting the stated accuracy at the stated time
< 10 km	70 seconds + 1.5 sec/km	2 cm + 0.5 ppm	75.0%
< 10 km	5 minutes	1 cm + 1 ppm	75.0%
< 15 km	4 minutes	5 cm	66.7%
< 25 km	7 minutes	7 cm	66.7%
< 35 km	10 minutes	35 cm	66.7%
< 35 km	30 minutes	25 cm	66.7%

Table E-4 RT-2 Performance: Kinematic Mode

Baseline length	Time since L2 lock-on with at least 6 satellites above mask angle	Horizontal accuracy at the stated time	Runs meeting the stated accuracy at the stated time
< 10 km	120 seconds + 1.5 sec/km	2 cm + 0.5 ppm	75.0%
< 15 km	8 minutes	8 cm	66.7%
< 25 km	14 minutes	10 cm	66.7%
< 35 km	20 minutes	40 cm	66.7%
< 35 km	60 minutes	25 cm	66.7%

PRTK logs contain some error due to predictions from base station observations. The expected error of a PRTK log will be that of the corresponding RTK log plus the appropriate error from *Table E-5*.

Table E-5 RT-2 Degradation With Respect To Data Delay ^①

Data Delay (sec)	Distance (km)	Accuracy (CEP)
0 - 2	1	+1 cm/sec
2 - 7	1	+2 cm/sec
7 - 30	1	+5 cm/sec
>30	1	single point or pseudorange differential positioning ^②

^① Mode = Static or Kinematic

^② After 30 seconds reverts to pseudorange positioning (single point or differential depending on messages previously received from the base station).

See *Section A.3, Page 65* for an overview of GPS positioning.

Figure E-1 Typical RT-2 Horizontal Convergence - Static Mode

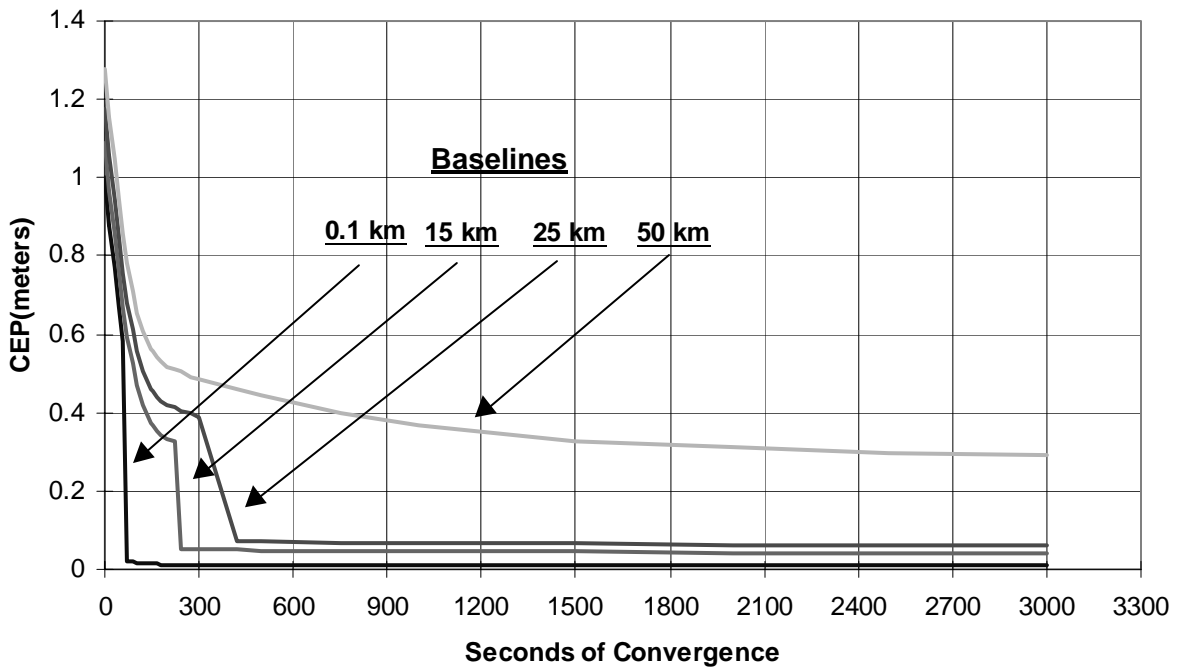
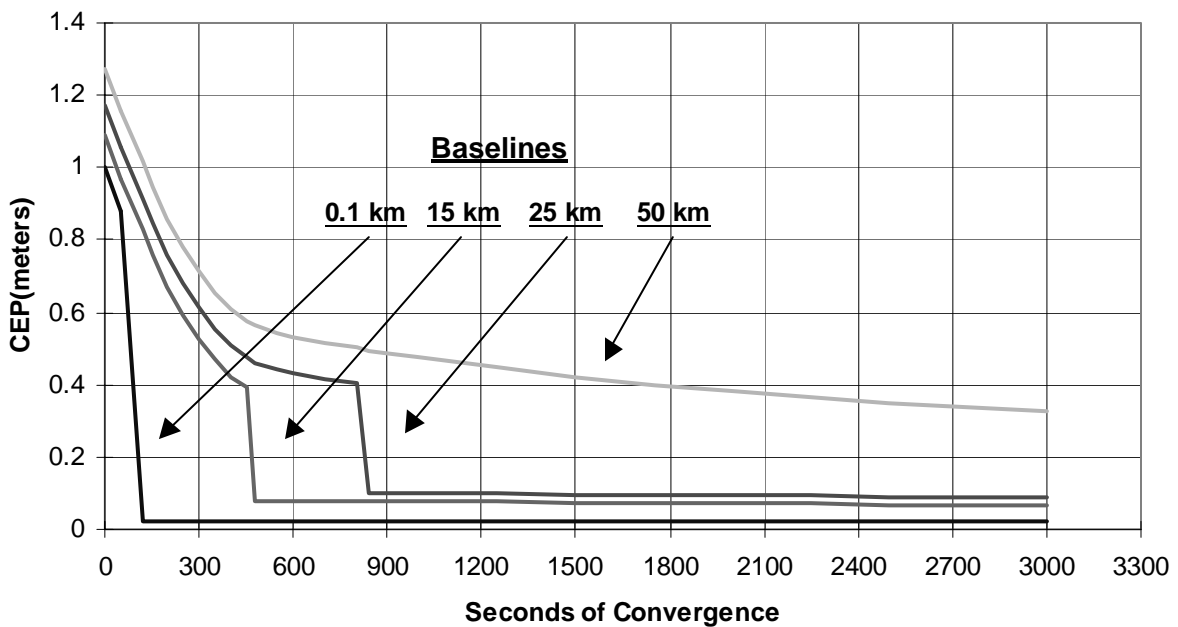

Figure E-2 Typical RT-2 Horizontal Convergence - Kinematic Mode



For baselines under 30 km long, the RT-2 solution shows two pronounced steps in accuracy convergence; these correspond to the single-point solution switching to the floating ambiguity solution which in turn switches to the narrow lane solution. If you were monitoring this using NovAtel's *GPSolution* program, the convergence sequence might look something like what is shown in *Figure E-3*.

Figure E-4 shows the performance of the RT-2 system running RTCM59 corrections at 1/2 Hz rate.

Figure E-3 RT-2 Accuracy Convergence

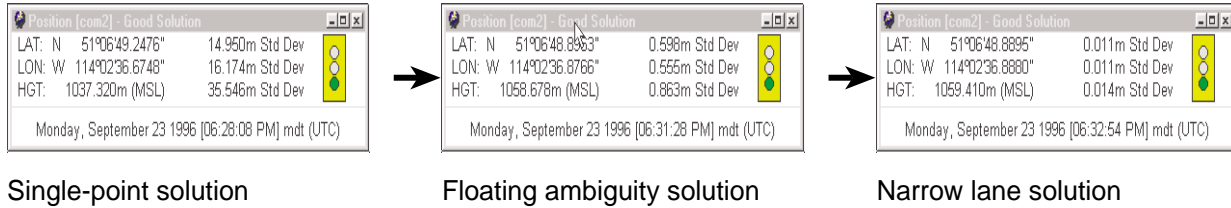
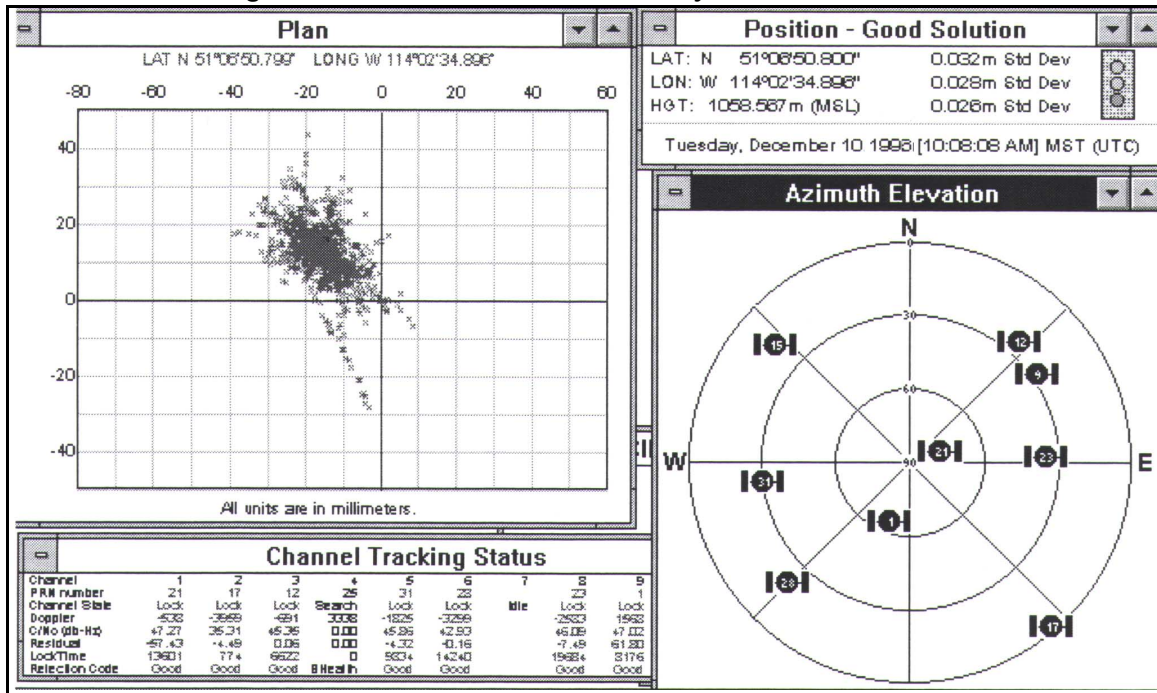

Figure E-4 Illustration of RT-2 Steady State Performance



RT-20 Performance

As shown in *Table E-6*, *Figure E-5* and *Figure E-6* the RT-20 system provides nominal 20 cm accuracy (CEP) after 3 minutes of continuous lock in static mode. After an additional period of continuous tracking (from 10 to 20 minutes), the system reaches steady state and position accuracies in the order of 3 to 4 cm are typical. The time to steady state is about 3 times longer in kinematic mode.

RT-20 double-difference accuracies are based on PDOP < 2 and continuous tracking of at least 5 satellites (6 preferred) at elevations of at least 11.5°.

All accuracy values refer to horizontal RMS error, and are based on low-latency positions. The level of position accuracy at any time will be reflected in the standard deviations output with the position.

Table E-6 RT-20 Performance

Tracking Time (sec)	Mode ¹	Data Delay (sec)	Distance (km)	Accuracy (CEP)
1 - 180	Static	0	1	100 to 25 cm
180 - 3000	Static	0	1	25 to 5 cm
> 3000	Static	0	1	5 cm or less ²
1 - 600	Kinematic	0	1	100 to 25 cm
600 - 3000	Kinematic	0	1	25 to 5 cm
> 3000	Kinematic	0	1	5 cm or less ²
	Either	0 - 2	1	+1 cm/sec
	Either	2 - 7	1	+2 cm/sec
	Either	7 - 30	1	+5 cm/sec
	Either	> 30	1	pseudorange or single point ³
	Either	0	0 - 10	+0.5 cm/km
	Either	0	10 - 20	+0.75 cm/km
	Either	0	20 - 50	+1.0 cm/km

- 1 Mode = Static or Kinematic (during initial ambiguity resolution)
- 2 The accuracy specifications refer to the PRTKA/B logs which include about 3 cm extrapolation error. RTKA/B logs are more accurate but have increased latency associated with them.
- 3 After 30 seconds reverts to pseudorange positioning (single point or differential depending on messages previously received from the base station).

Figure E-5 Typical RT-20 Convergence - Static Mode

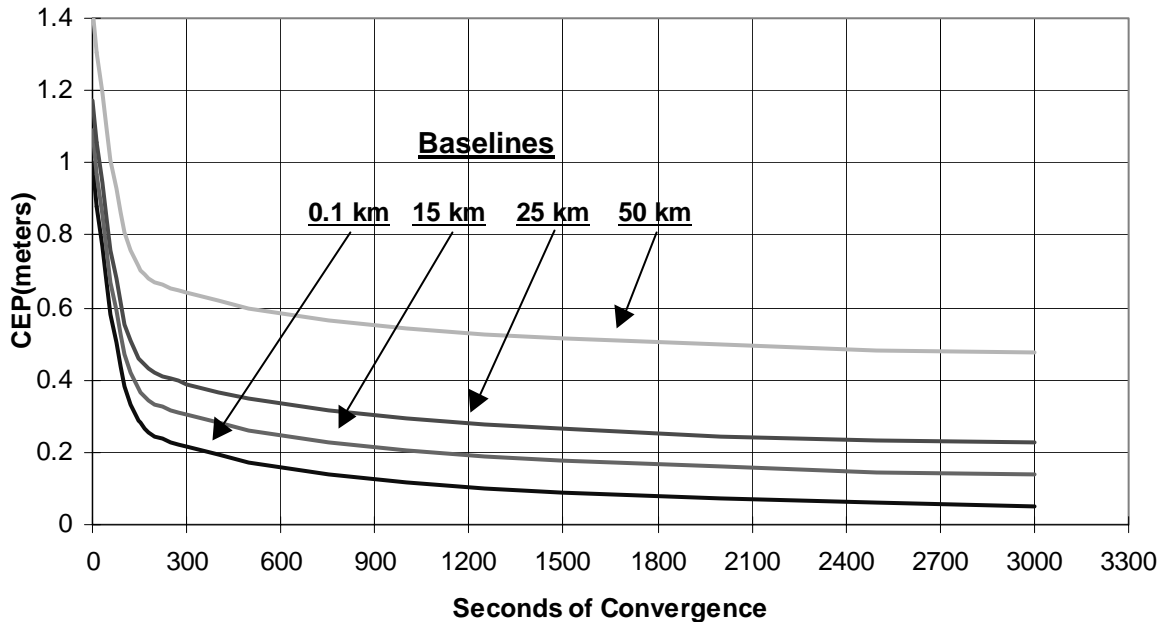

Figure E-6 Typical RT-20 Convergence - Kinematic Mode

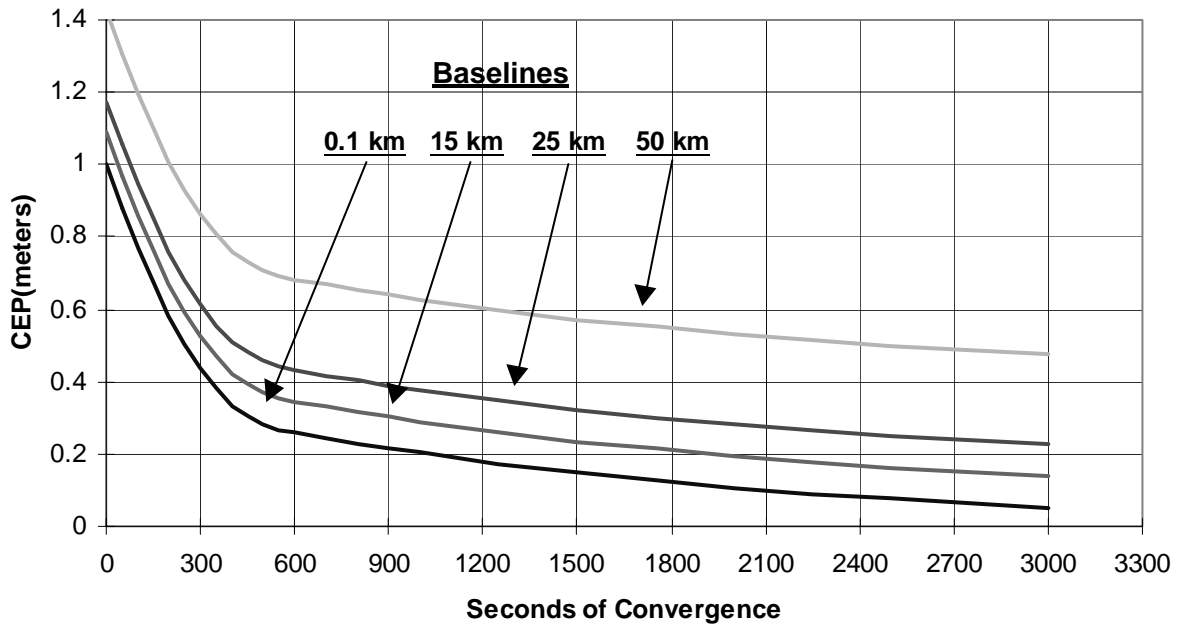
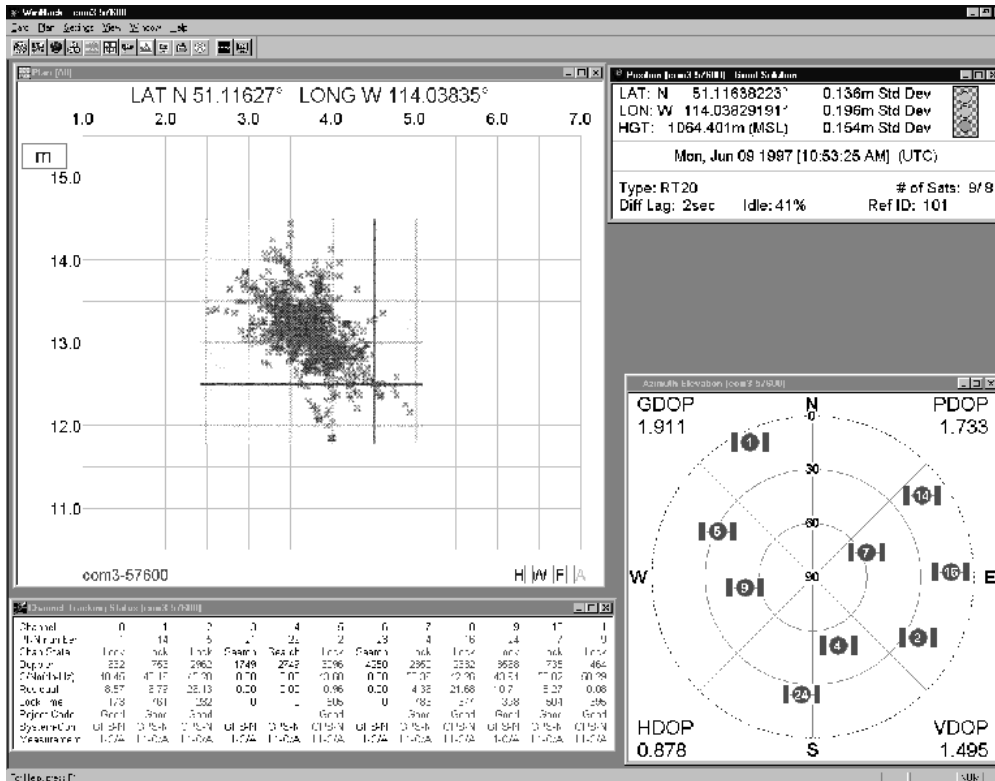

Figure E-7 shows the performance of the RT-20 system running with RTCM59 corrections received at a 1/2 Hz rate.

Figure E-7 RT-20 Steady State Performance



E.2 PERFORMANCE CONSIDERATIONS

When referring to the “performance” of RTK software, two factors are introduced:

1. *Baseline length*: the position estimate becomes less precise as the baseline length increases. Note that the baseline length is the distance between the *phase centres* of the two antennas. Identifying the exact position of your antenna’s phase centre is essential; this information is typically supplied by the antenna’s manufacturer or vendor.

The RTK software automatically makes the transition between short and longer baselines, but the best results are obtained for baselines less than 10 km. The following are factors which are related to baseline length:

- ephemeris errors - these produce typical position errors of 0.75 cm per 10 km of baseline length.
- ionospheric effects - the dominant error for single-frequency GPS receivers on baselines exceeding 10 km. Differential ionospheric effects reach their peak at dusk and dawn, being at a minimum during hours of darkness. Ionospheric effects can be estimated and removed on dual-frequency GPS receivers, greatly increasing the permissible baseline length, but at the cost of introducing additional “noise” to the solution. Therefore, this type of compensation is only used in cases where the ionospheric error is much larger than the noise and multipath error.
- tropospheric effects - these produce typical position errors of approximately 1 cm per 10 km of baseline length. This error increases if there is a significant height difference between the reference and remote stations, as well as if there are significantly different weather conditions between the two sites.

A related issue is that of multipath interference, the dominant error on short differential baselines. Generally, multipath can be reduced by choosing the antenna’s location with care, and by the use of a choke-ring antenna ground plane, see *Appendix B, Page 75*.

2. *Convergence time*: the position estimate becomes more accurate and more precise with time. However, convergence time is dependent upon baseline length: while good results are available after a minute or so for short baselines, the time required increases with baseline length. Convergence time is also affected by the number of satellites which can be used in the solution: the more satellites, the faster the convergence.

Performance Degradation

The performance will degrade if satellites are lost at the remote or if breaks occur in the differential correction transmission link. The degradations related to these situations are described in the following paragraphs.

Provided lock is maintained on at least 4 SVs and steady state has been achieved, the only degradation will be the result of a decrease in the geometrical strength of the observed satellite constellation. If steady state has not been achieved, then the length of time to ambiguity resolution under only 4-satellite coverage will be increased significantly.

REMOTE TRACKING LOSS

If less than 4 satellites are maintained, then the RTK filter can not produce a position. When this occurs, the POSA/B and P20A/B logs will be generated with differential (if RTCM Type 1 messages are transmitted with the Type 59 messages) or single point pseudorange solutions if possible. When the satellites are reacquired, the RTK initialization process described below occurs (see *Figure E-8, Page 238*).

DIFFERENTIAL LINK BREAKDOWN

1. Provided the system is in steady state, and the loss of observation data is for less than 30 seconds, the RTK positions will degrade according to the divergence of the reference observation extrapolation filters. This causes a decrease in accuracy of about an order of magnitude per 10 seconds without a reference station observation, and this degradation is reflected in the standard deviations of the low latency logs. Once the data link has been re-established, the accuracy will return to normal after several samples have been received.
2. If the loss of differential corrections lasts longer than 30 seconds, the RTK filter is reset and all ambiguity and reference model information is lost. The timeout threshold for RTK differential corrections is 30 seconds, but for Type 1 pseudorange corrections, the timeout is 60 seconds. Therefore, when the RT-20 can no longer function because of this timeout, the pseudorange filter can produce differential positions for an additional 30 seconds (provided RTCM Type 1 messages were transmitted along with the Type 59 messages) before the system reverts to single point positioning. Furthermore, once the link is re-established, the pseudorange filter produces an immediate differential position while the RTK filter takes an additional 14 seconds to generate its positions. The reference models require 7 reference observations before they are declared usable, and this will take 14 seconds, based on a 1/2 Hz differential correction rate. The reference model must be healthy before solutions are logged to the low latency logs, so there is a delay in the use of real time carrier positioning to the user once the link has been re-established. The RTK logs (RTCA/B, RTKA/B AND BSLA/B) use matched observations only (no extrapolated observations), and these will be available after three reference observations are received, but will have about 1.5 seconds latency associated with them.

Figure E-8 RT-20 Re-initialization Process

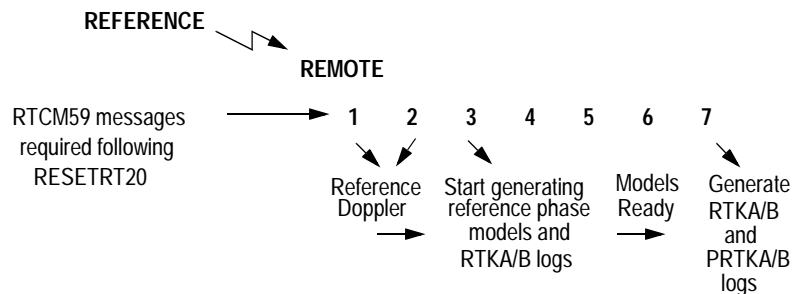

The RTK system is based on a time-matched double difference observation filter. This means that observations at the remote site have to be buffered while the reference station observation is encoded, transmitted, and decoded. Only two seconds of remote observations are saved, so the reference station observation transmission process has to take less than 2 seconds if any time matches are to be made. In addition, only remote observations on whole second boundaries are retained (e.g. measurements made at 3.0, 4.0 or 5.0 seconds of the week are retained, but not measurements made at 3.5, 4.1 or 5.25 seconds), so monitor observations must also be sent on whole seconds if time matches are to be made. The following shows the correct and incorrect way to send corrections:

Correct. Corrections should be sent like this:

```
LOG COM2 RTCM59 ONTIME 2.0 0.0
```

Incorrect. Do not attempt to send corrections like this:

```
LOG COM2 RTCM59 ONTIME 2.0 0.5
```

F**STANDARDS AND REFERENCES****RTCM STANDARDS REFERENCE**

For detailed specifications of RTCM, refer to RTCM SC104 Version 2.1 of "RTCM Recommended Standards For Differential NAVSTAR GPS Service", January 3, 1994

Radio Technical Commission for Maritime Services
655 15th Street NW, Suite 300
Washington, D.C. 20005 U.S.A.

Telephone: 202-639-40061 Fax: 202-347-8540

Website: <http://www.navcen.uscg.mil/dgps/dgeninfo>

RTCA STANDARDS REFERENCE

For copies of the Minimum Aviation System Performance Standards DGNSS Instrument Approach System: Special Category-I (SCAT-I), contact:

RTCA, Incorporated
1140 Connecticut Avenue N.W., Suite 1020
Washington, D.C. 20036-4001 U.S.A.

Telephone: 202-833-9339 Fax: 202-833-9434

Website: <http://www.rtca.org>

GPS SPS SIGNAL SPECIFICATION REFERENCE

For copies of the Interface Control Document (ICD)-GPS-200, contact:

ARINC Research Corporation
2551 Riva Road
Annapolis, MD 21401-7465 U.S.A.

Telephone: 410-266-4000 Fax: 410-266-4049

Website: <http://www.arinc.com>

NMEA REFERENCE

National Marine Electronics Association, NMEA 0183 Standard for Interfacing Marine Electronic Devices, Version 2.00, January 1, 1992

NMEA Executive Director
P.O. Box 50040
Mobile, Alabama 36605 U.S.A.

Telephone: 252-638-2626 Fax: 252-638-4885

Website: <http://www.nmea.org>

GEODETTIC SURVEY OF CANADA

Geodetic Survey of Canada
615 Boothe Street
Ottawa, Ontario, Canada
K1A 0E9

Telephone: 613-995-4410 Fax: 613-995-3215

Website: <http://www.geod.emr.ca>

U.S. NATIONAL GEODETTIC SURVEY

NGS Information Services
1315 East-West Highway
Station 9244
Silver Springs, MD 20910-3282 U.S.A.

Telephone: 301-713-2692 Fax: 301-713-4172

Website: <http://www.ngs.noaa.gov>

NOTE: Website addresses, postal addresses and telephone numbers may be subject to change; however, they are believed to be accurate at the time of publication.

G GEODETIC DATUMS

The following tables contain the internal ellipsoid parameters and transformation parameters used in the GPSCard. The values contained in these tables were derived from the following DMA technical reports:

1. TR 8350.2 Department of Defence World Geodetic System 1984 and Relationships with Local Geodetic Systems - Revised March 1, 1988.
2. TR 8350.2B Supplement to Department of Defence World Geodetic System 1984 Technical Report - Part II - Parameters, Formulas, and Graphics for the Practical Application of WGS84 - December 1, 1987.

Table G-1 Reference Ellipsoid Constants

ELLIPSOID	ID CODE	a (metres)	1/f	f
Airy 1830	AW	6377563.396	299.3249647	0.00334085064038
Modified Airy	AM	6377340.189	299.3249647	0.00334085064038
Australian National	AN	6378160.0	298.25	0.00335289186924
Bessel 1841	BR	6377397.155	299.1528128	0.00334277318217
Clarke 1866	CC	6378206.4	294.9786982	0.00339007530409
Clarke 1880	CD	6378249.145	293.465	0.00340756137870
Everest (India 1830)	EA	6377276.345	300.8017	0.00332444929666
Everest (Brunei & E.Malaysia)	EB	6377298.556	300.8017	0.00332444929666
Everest (W.Malaysia & Singapore)	ED	6377304.063	300.8017	0.00332444929666
Geodetic Reference System 1980	RF	6378137.0	298.257222101	0.00335281068118
Helmert 1906	HE	6378200.0	298.30	0.00335232986926
Hough 1960	HO	6378270.0	297.00	0.00336700336700
International 1924	IN	6378388.0	297.00	0.00336700336700
South American 1969	SA	6378160.0	298.25	0.00335289186924
World Geodetic System 1972	WD	6378135.0	298.26	0.00335277945417
World Geodetic System 1984	WE	6378137.0	298.257223563	0.00335281066475

Table G-2 Transformation Parameters (Local Geodetic to WGS84)

GPSCard Datum ID number	NAME	DX	DY	DZ	DATUM DESCRIPTION	ELLIPSOID
1	ADIND	-162	-12	206	Adindan (Ethiopia, Mali, Senegal & Sudan)	Clarke 1880
2	ARC50	-143	-90	-294	ARC 1950 (SW & SE Africa)	Clarke 1880
3	ARC60	-160	-8	-300	ARC 1960 (Kenya, Tanzania)	Clarke 1880
4	AGD66	-133	-48	148	Australian Geodetic Datum 1966	Australian National
5	AGD84	-134	-48	149	Australian Geodetic Datum 1984	Australian National
6	BUKIT	-384	664	-48	Bukit Rimpah (Indonesia)	Bessel 1841
7	ASTRO	-104	-129	239	Camp Area Astro (Antarctica)	International 1924
8	CHATM	175	-38	113	Chatum 1971 (New Zealand)	International 1924
9	CARTH	-263	6	431	Carthage (Tunisia)	Clarke 1880
10	CAPE	-136	-108	-292	CAPE (South Africa)	Clarke 1880
11	DJAKA	-377	681	-50	Djakarta (Indonesia)	Bessel 1841
12	EGYPT	-130	110	-13	Old Egyptian	Helmert 1906
13	ED50	-87	-98	-121	European 1950	International 1924
14	ED79	-86	-98	-119	European 1979	International 1924
15	GUNSG	-403	684	41	G. Segara (Kalimantan - Indonesia)	Bessel 1841
16	GEO49	84	-22	209	Geodetic Datum 1949 (New Zealand)	International 1924

Table G-2 Transformation Parameters (Local Geodetic to WGS84)

17	GRB36	375	-111	431	Great Britain 1936 (Ordinance Survey)	Airy 1830
18	GUAM	-100	-248	259	Guam 1963 (Guam Island)	Clarke 1866
19	HAWAII	89	-279	-183	Hawaiian Hawaii (Old)	International 1924
20	KAUAI	45	-290	-172	Hawaiian Kauai (Old)	International 1924
21	MAUI	65	-290	-190	Hawaiian Maui (Old)	International 1924
22	OAHU	56	-284	-181	Hawaiian Oahu (Old)	International 1924
23	HERAT	-333	-222	114	Herat North (Afghanistan)	International 1924
24	HJORS	-73	46	-86	Hjorsey 1955 (Iceland)	International 1924
25	HONGK	-156	-271	-189	Hong Kong 1963	International 1924
26	HUTZU	-634	-549	-201	Hu-Tzu-Shan (Taiwan)	International 1924
27	INDIA	289	734	257	Indian (India, Nepal, Bangladesh)	Everest (EA)
28	IRE65	506	-122	611	Ireland 1965	Modified Airy
29	KERTA	-11	851	5	Kertau 1948 (West Malaysia and Singapore)	Everest (ED)
30	KANDA	-97	787	86	Kandawala (Sri Lanka)	Everest (EA)
31	LIBER	-90	40	88	Liberia 1964	Clarke 1880
32	LUZON	-133	-771	-51	Luzon (Philippines excluding Mindanao Is.)	Clarke 1866
33	MINDA	-133	-70	-72	Mindanao Island	Clarke 1866
34	MERCH	31	146	47	Merchich (Morocco)	Clarke 1880
35	NAHR	-231	-196	482	Nahrwan (Saudi Arabia)	Clarke 1880
36	NAD83	0	0	0	N. American 1983 (Includes Areas 37-42)	GRS-80
37	CANADA	-10	158	187	N. American Canada 1927	Clarke 1866
38	ALASKA	-5	135	172	N. American Alaska 1927	Clarke 1866
39	NAD27	-8	160	176	N. American Conus 1927	Clarke 1866
40	CARIBB	-7	152	178	N. American Caribbean	Clarke 1866
41	MEXICO	-12	130	190	N. American Mexico	Clarke 1866
42	CAMER	0	125	194	N. American Central America	Clarke 1866
43	MINNA	-92	-93	122	Nigeria (Minna)	Clarke 1880
44	OMAN	-346	-1	224	Oman	Clarke 1880
45	PUERTO	11	72	-101	Puerto Rica and Virgin Islands	Clarke 1866
46	QORNO	164	138	-189	Qornoq (South Greenland)	International 1924
47	ROME	-255	-65	9	Rome 1940 Sardinia Island	International 1924
48	CHUA	-134	229	-29	South American Chua Astro (Paraguay)	International 1924
49	SAM56	-288	175	-376	South American (Provisional 1956)	International 1924
50	SAM69	-57	1	-41	South American 1969	S. American 1969
51	CAMPO	-148	136	90	S. American Campo Inchauspe (Argentina)	International 1924
52	SACOR	-206	172	-6	South American Corrego Alegre (Brazil)	International 1924
53	YACAR	-155	171	37	South American Yacare (Uruguay)	International 1924
54	TANAN	-189	-242	-91	Tananarive Observatory 1925 (Madagascar)	International 1924
55	TIMBA	-689	691	-46	Timbalai (Brunei and East Malaysia) 1948	Everest (EB)
56	TOKYO	-128	481	664	Tokyo (Japan, Korea and Okinawa)	Bessel 1841
57	TRIST	-632	438	-609	Tristan Astro 1968 (Tristan du Cunha)	International 1924
58	VITI	51	391	-36	Viti Levu 1916 (Fiji Islands)	Clarke 1880
59	WAK60	101	52	-39	Wake-Eniwetok (Marshall Islands)	Hough 1960
60	WGS72	0	0	4.5	World Geodetic System - 72	WGS72
61	WGS84	0	0	0	World Geodetic System - 84	WGS84
62	ZANDE	-265	120	-358	Zanderidj (Surinam)	International 1924
63	USER	0	0	0	User Defined Datum Defaults	User *

Notes:

- * Default user datum is WGS84.
- * Also see the *DATUM* and *USERDATUM* commands in *Chapter 2* and *Appendix C*.
- * The GPSCard *DATUM* command sets the Datum value based on the name entered as listed in the "NAME" column in Table G-2 (e.g., NAD83).
- * These GPSCard logs report Datum used according to the "GPSCard Datum ID" column: POSA/B, PRTKA/B, RTKA/B, and MKPA/B.

H
SOME COMMON UNIT CONVERSIONS

Section *H.1* to *H.4* list commonly used equivalents between the SI (Système Internationale) units of weights and measures used in the metric system, and those used in the imperial system. A complete list of hexadecimal values with their binary equivalents is given in Section *H.5* while an example of the conversion from GPS time of week to calendar day is shown in Section *H.6*.

H.1 DISTANCE

1 meter (m) = 100 centimeters (cm) = 1000 millimeters (mm)

1 kilometer (km) = 1000 meters (m)

1 nautical mile = 1852 meters

1 international foot = 0.3048 meter

1 statute mile = 1609 meters

1 US survey foot = 0.3048006096 meter

H.2 VOLUME

1 liter (l) = 1000 cubic centimeters (cc)

1 gallon (Imperial) = 4.546 liters

1 gallon (US) = 3.785 liters

H.3 TEMPERATURE

degrees Celsius = $(5/9) \times [(degrees\ Fahrenheit) - 32]$

degrees Fahrenheit = $[(9/5) \times (degrees\ Celsius)] + 32$

H.4 WEIGHT

1 kilogram (kg) = 1000 grams

1 pound = 0.4536 kilogram (kg)

H.5 HEXADECIMAL AND BINARY EQUIVALENTS

Hexadecimal	Binary
0	0000
1	0001
2	0010
3	0011
4	0100
5	0101
6	0110
7	0111
8	1000
9	1001
A	1010
B	1011
C	1100
D	1101
E	1110
F	1111



H.6 GPS TIME OF WEEK TO CALENDAR DAY (EXAMPLE)

511200 seconds	Day	$511200 / 86400$ seconds per day	=	5.916666667 days
	Hour	$.916666667 \times 86400 / 3600$ seconds per hour	=	22.0000 hours
	Minute	$.000 \times 3600 / 60$ seconds per minute	=	0.000 minutes
	Second	$.000 \times 60$	=	0.00 seconds

Day 5 (Thursday) + 22 hours, 0 minutes, 0 seconds into Friday.

H.6.1 Calendar Date to GPS Time (e.g. 13:30 hours, January 28, 2005)

Days from January 6, 1980 to January 28, 2005 = 6 years x 365 days /year = 9125 days

Add one day for each leap year (a year which is divisible by 4 but not by 100 unless it is divisible by 400;

every 100 years a leap year is skipped) 7 days

Days into 2005 (28th is not finished) 27 days

Total days 9159 days

Deduct 5 days: Jan. 1 through 5, 1980 9154 days

GPS Week: 9154×86400 seconds per day = 790905600 seconds/ 604800 sec per week = **785**

Seconds into week 6th day: $13.5 \text{ hrs} \times 3600 \text{ sec/hr}$ **48600** seconds

GPS time of week: **Week 1307, 48600 second**

I

INFORMATION MESSAGES

TYPE 1 INFORMATION MESSAGES

To date, the only Type 1 messages are the !ERRA and the !MSGGA logs.

!ERRA

```
!ERRA type severity error string opt. description *xx [CR][LF]
```

Field #	Field type	Data Description
1	!ERRA	Log header
2	type	Log type, numbered 0 - 999 (see <i>Table I-1</i> below)
3	severity	Only one is defined to date: severity_fatal (number = 0); causes reset
4	error string	Error message (see <i>Table I-1</i>)
5	opt. description	Optional description
6	*xx	Checksum
7	[CR][LF]	Sentence terminator

Example:

```
!ERRA,1,0,Authorization Code Invalid,*22[CR][LF]
```

Table I-1 Type 1 !ERRA Types

Log type	Error String
0	Unknown ERRA Type
1	Authorization Code Invalid
2	No Authorization Code Found
3	Invalid Expiry In Authorization Code
4	Unable To Read ESN
5	Reserved For Future Use
6	Card Has Stopped Unexpectedly
7+	Reserved For Future Use

!MSGGA

```
!MSGGA type message opt. description *xx [CR][LF]
```

Field #	Field type	Data Description
1	!MSGGA	Log header
2	type	Log type, numbered from 1000 (see <i>Table I-2</i> , Page 245)
3	message	Message (see <i>Table I-2</i>)
4	opt. description	Optional description
5	*xx	Checksum
6	[CR][LF]	Sentence terminator

Example:

```
!MSGGA,1001,Authorization Code Is Time Limited, Model 3951R Expires on  
960901*6C[CR][LF]
```

Table I-2 Type 1 !MSGA Types

Log type	Message String
1000	Unknown MSGA Type
1001	Authorization Code Is Time Limited
1002+	Reserved For Future Use

TYPE 2 INFORMATION MESSAGES

The following is a list of information messages which are generated by the Command Interpreter in response to a user's input. This list is not necessarily complete, but it is the most accurate one available at the time of publication. It is intended to be a trouble-shooting tool.

Error Message	Meaning
All Ok	No errors to report.
Argument Must Be Hexadecimal (0-9,A-F) Pairs	An argument which is not hexadecimal was entered.
Argument Must Be Numeric	An argument which is not numeric was entered.
Authorization Changes Not Available On This Card	An attempt has been made to change the Authorization Code on a card which is not an OEM card.
Authorization Code Entered Incorrectly	The checksum is incorrect for the Authorization Code. The Authorization Code was most likely entered incorrectly.
Authorization Code Is Invalid	The existing Authorization Code is invalid. Please contact NovAtel GPS customer service for a new Authorization Code.
Can't Change Authorization Code	The existing Authorization Code cannot be changed. Please contact NovAtel GPS customer service for assistance.
Clock Model not set TM1A rejected	The clock model status in a \$TM1A command is invalid. The \$TM1A command is rejected when the clock model has not been set.
CLOCK_ADJUST Command Not Available On This Model	The CLOCKADJUST command is not available on this model.
Complete Almanac not received yet - try again later	The almanac cannot be saved because a complete almanac has not yet been received. A SAVEALMA command should be performed at a later time when a complete almanac has been received.
Data Too Large To Save To NVM	The configuration data being saved is too large.
Differential Corrections Not Available On This Model	This model does not have the ability to send or receive differential corrections.
EXTERNALCLOCK Command Not Available On This Model	The EXTERNALCLOCK command is not available on this model.
FREQUENCY_OUT Command Not Available On This Model	The FREQUENCY_OUT command is not available on this model.
FROM port name too LONG	The FROM port name in a SETNAV command is too long.
Invalid \$ALMA CheckSum	The checksum of a \$ALMA command is invalid.
Invalid \$DCSA CheckSum	The checksum of a \$DCSA command is invalid.
Invalid \$DEBUG Options	An invalid option was entered in the \$DEBUG command.
Invalid \$IONA CheckSum	The checksum of a \$IONA command is invalid.
Invalid \$PXYA CheckSum	The checksum of a \$PXYA command is invalid.
Invalid \$REPA CheckSum	The checksum of a \$REPA command is invalid.
Invalid \$RTCA CheckSum/CRC	The CRC of a \$RTCA command is invalid.
Invalid \$RTCM CheckSum	The checksum of a \$RTCA command is invalid.
Invalid \$TM1A CheckSum	The checksum of a \$TM1A command is invalid.
Invalid \$UTCA CheckSum	The checksum of a \$UTCA command is invalid.
Invalid \$VXYA CheckSum	The checksum of a \$VXYA command is invalid.
Invalid ADJUSTCLOCK Option	An invalid CLOCKADJUST switch has been entered.
Invalid Baudrate	The bit rate in a COMn command is invalid.
Invalid Carrier Smoothing Constant	The carrier smoothing constant of the CSMOOTH command is invalid.

Invalid Channel Number	An invalid channel number has been entered in a command such as ASSIGN.
Invalid Coarse Modulus Field	The coarsemod argument of the FREQUENCY_OUT command is invalid.
Invalid Command CRC	The received command has an invalid checksum.
Invalid Command Name	An invalid command name has been received.
Invalid Command Option	One or more arguments of a command are invalid.
Invalid Coordinates	Invalid coordinates received in a command such as \$PVCA, \$PXYA, etc.
Invalid Datatype	The data type in an ACCEPT command is invalid.
Invalid Datum Offset	The datum offset in a USERDATUM command is invalid.
Invalid DATUM Option	An option in a DATUM command is invalid.
Invalid Datum Rotation	The datum rotation angle in a USERDATUM command is invalid.
Invalid Degree Field	An invalid degree field has been entered in a command such as FIX POSITION or SETNAV.
Invalid DGPS time-out value	An invalid timeout value was entered in the DGPSTIMEOUT command.
Invalid Doppler	An invalid Doppler has been entered in an ASSIGN command.
Invalid Doppler Window	An invalid Doppler window has been entered in an ASSIGN command.
Invalid DTR choice	An invalid option was entered in the COMn_DTR command.
Invalid DTR Toggle Option	The active option in the COMn_DTR command is invalid.
Invalid DTR Toggle Setup Time (0-1000)	The lead time option in the COMn_DTR command is invalid.
Invalid DTR Toggle Terminate Time (0-1000)	The tail time option in the COMn_DTR command is invalid.
Invalid DYNAMICS Option	The option in a DYNAMICS command is invalid.
Invalid Echo Option	The echo option in a COMn command is invalid.
Invalid Elevation Cutoff Angle	The elevation cutoff angle in an ECUTOFF command is invalid.
Invalid ERRMSG Flag	The option (on/off) specified in a MESSAGE command is invalid.
Invalid ERRMSG Port	The port specified in a MESSAGE command is invalid.
Invalid EXTERNALCLOCK Option	An invalid external clock was entered in the EXTERNALCLOCK command.
Invalid EXTERNALCLOCK USER Argument(s)	An invalid argument was entered in the EXTERNALCLOCK command.
Invalid Fine Modulus Field	The finemod argument of the FREQUENCY_OUT command is invalid.
Invalid FIX Option	An option other than height, position or velocity was specified in a FIX command.
Invalid Flattening	The flattening in a USERDATUM command is invalid.
Invalid Handshake Option	The handshake option in a COMn command is invalid.
Invalid HEALTH Override	An invalid health has been entered in a SETHEALTH or FIX command.
Invalid Height	The height in a FIX HEIGHT command is invalid.
Invalid Logger Datatype	An invalid log has been specified in a LOG/UNLOG command.
Invalid Logger Offset	An invalid offset has been specified in a LOG command.
Invalid Logger Period	An invalid period has been specified in a LOG command.
Invalid Logger Port Option	An invalid port number has been specified in a LOG/UNLOG command.
Invalid Logger Trigger	An invalid trigger has been specified in a LOG command.
Invalid Magnetic Variation	The magnetic variation in a MAGVAR command is invalid.
Invalid Number of \$ALMA Arguments	The number of arguments in a \$ALMA command is invalid.
Invalid Number of \$DCSA Arguments	The number of arguments in a \$DCSA command is invalid.
Invalid Number of \$IONA Arguments	The number of arguments in a \$IONA command is invalid.
Invalid Number of \$PXYA Arguments	The number of arguments in a \$PXYA command is invalid.
Invalid Number of \$REPA Arguments	The number of arguments in a \$REPA command is invalid.
Invalid Number of \$TM1A Arguments	The number of arguments in a \$TM1A command is invalid.
Invalid Number of \$UTCA Arguments	The number of arguments in a \$UTCA command is invalid.
Invalid Number of \$VXYA Arguments	The number of arguments in a \$VXYA command is invalid.
Invalid Number of Arguments	A command has been received which has an invalid number of arguments.
Invalid Number of Databits	The number of data bits in a COMn command is invalid.
Invalid Number of StopBits	The number of stop bits in a COMn command is invalid.

Invalid Parity Option	The parity in a COMn command is invalid.
Invalid Port	The port in a SEND command is invalid.
Invalid Port number	The port number in an ACCEPT command is invalid.
Invalid PPS Modulus Field	The ppsmod argument of the FREQUENCY_OUT command is invalid.
Invalid RINEX Option	An option of a RINEX command is invalid.
Invalid RTCA option	An invalid RTCA rule has been entered.
Invalid RTCA station Name (XXXXX)	The RTCA station name in a FIX POSITION message is invalid.
Invalid RTCM Bit Rule	An invalid RTCM rule has been entered.
Invalid RTCM station Name (0..1023)	The RTCM station name in a FIX POSITION message is invalid.
Invalid RTCM16T string length - maximum 90	The RTCM16T string exceeds 90 characters.
Invalid RTS choice	An invalid option was entered in the COMn_RTS command.
Invalid RTS Toggle Option	The active option in the COMn_RTS command is invalid.
Invalid RTS Toggle Setup Time (0-1000)	The lead time option in the COMn_RTS command is invalid.
Invalid RTS Toggle Terminate Time (0-1000)	The tail time option in the COMn_RTS command is invalid.
Invalid Satellite Number	An invalid satellite number has been entered in an ASSIGN, SETHEALTH, LOCKOUT or UNLOCKOUT command.
Invalid Scaling	The scale value in a USERDATUM command is invalid.
Invalid Seconds Into Week in TM1A	The time in a \$TM1A command is invalid.
Invalid SemiMajor Axis	The semi-major axis in a USERDATUM command is invalid.
Invalid Standard Deviation Limit (0.1-100 m)	A standard deviation in a POSSE command is invalid.
Invalid Symbol Period 1,2,4,5,10,20	The symbol period is invalid for an ASSIGN on a pseudolite channel.
Invalid Time Limit (0.1-100 hours)	The averaging time in a POSAVE command is invalid.
Invalid Token	This error should never occur. If it does, please contact NovAtel GPS customer service.
Invalid Track Offset	The track offset in the SETNAV command is invalid.
Invalid Velocity	An invalid velocity has been received, either in a FIX VELOCITY command, or in a command such as \$PVCA, \$PVCB.
Invalid Week Number in TM1A	The week in a \$TM1A command is invalid.
MET Command Not Available On This Model	The MET command is not available on this model.
Model Invalid	The Authorization Code has an invalid Model. Please contact NovAtel GPS customer service for assistance.
NVM Error - Unable To Save	The SAVE operation did not complete successfully.
RINEX string too LONG	Indicates that the entered RINEX command is too long.
RT20 Logs Not Available On This Model	This model does not have the ability to send or receive RT20 differential corrections.
RTCM9 Logs Not Available On This Model	This model does not have the ability to send or receive RTCM9 logs.
SAVE Command Not Available On This Model	A SAVE operation was attempted which is not available on this model.
Save Complete	The SAVE operation completed successfully.
SETCLOCK disabled TM1A rejected	The \$TM1A command is rejected because the user has not enabled clock synchronization using the SETCLOCK command.
Standard Deviation not allowed with small time limits	In a POSAVE command, a standard deviation cannot be entered with a small time. Enter a larger averaging time if standard deviations are desired.
TO Portname too LONG	The TO port name in a SETNAV command is too long.
User Defined DATUM Not Set	This error should not occur. By default the user defined DATUM is set to WGS84. If you get this error message, please contact NovAtel GPS customer service.
Valid Option but Missing Process	This message indicates an error in the software. A command option is valid but software cannot process it

J LISTING OF TABLES

This section is provided for ease of reference. The tables reproduced are as follows:

1-1	GPSCard Pseudorange Differential Initialization Summary
1-2	Latency - Induced Extrapolation Error
2-1	Commands Table
2-2	GPSCard Command Summary Chart
3-1	Logs Table
3-2	GPSCard Log Summary
4-1	Positioning Modes
C-1	Antenna LNA Power Configuration
C-2	Default Values of Process Noise Elements
C-3	VARF Range
D-1	GPSCard Solution Status
D-2	Position Type
D-3	RTK Status For Position Type 3 (RT-20)
D-4	RTK Status For Position Type 4 (RT-2)
D-5	Receiver Self-Test Status Codes
D-6	Range Record Formats (RGED only)
D-7	Channel Tracking Status
D-8	Ambiguity Types
D-9	Searcher Status
D-10	RTK Status
D-11	GPSCard Range Reject Codes
D-12	GPSCard Velocity Status
E-1	Comparison of RT-2 and RT-20
E-2	RTK Messages Vs. Accuracy
E-3	RT-2 Performance - Static Mode
E-4	RT-2 Performance - Kinematic Mode
E-5	RT-20 Performance

Table 1-1 GPSCard Pseudorange Differential Initialization Summary

Reference Station	Remote Station
<p>Required: FIX POSITION <i>lat lon hgt id (health)</i> LOG <i>port DATATYPE</i> ontime 5</p> <p>Recommended Options: LOG <i>DATATYPES</i> (binary): RTCMB RTCAB RTCM RTCA</p> <p>LOG <i>DATATYPES</i> (<i>ascii</i>): RTCMA RTCAA</p> <p>Related Commands/Logs: RTCMRULE DATUM</p>	<p>Required: ACCEPT <i>port DATATYPE</i></p> <p>Recommended Options: ACCEPT <i>DATATYPES</i> (binary): RTCM RTCA</p> <p>ACCEPT <i>COMMANDS</i> (<i>ascii</i>): RTCMA RTCAA</p> <p>Related Commands/Logs: RTCMRULE DATUM POSA/B VLHA/B CDSA/B GPGGA</p>
<p>Example 1: fix position 51.3455323 -114.2895345 1201.123 555 0 log com 1 RTCM ontime 2</p> <p>Example 2: fix position 51.3455323 -114.2895345 1201.123 555 0 log com2 rtca ontime 2</p>	<p>Example 1: accept com2 rtcm log com1 posa ontime 1</p> <p>Example 2: accept com2 commands log com1 posa ontime 0.2 log com1 vlha ontime 0.2</p>
<p>Note: <i>Italicized</i> entries indicate user definable.</p>	

Table 1-2 Latency-Induced Extrapolation Error

Time since last reference station observation	Typical extrapolation error (CEP)
0-2 seconds	1 cm/sec
2-7 seconds	2 cm/sec
7-30 seconds	5 cm/sec

Table 2-1 Commands By Function Table

COMMUNICATIONS, CONTROL AND STATUS	
Commands	Descriptions
ANTENNAPOWER	Power to the low-noise amplifier of an active antenna
COMn	COMn port configuration control
COMn_DTR	DTR handshaking control
COMn_RTS	RTS handshaking control
DIFF_PROTOCOL ¹	Differential Protocol Control
FREQUENCY_OUT	Variable frequency output (programmable)
LOG	Logging control
MESSAGES	Disable error reporting from command interpreter
RINEX	Configure the user defined fields in the file header
RTCMRULE	Sets up RTCM bit rule
RTCM16T	Enters an ASCII message
SEND	Sends ASCII message to COM port
SENDHEX	Sends non-printable characters
SETL1OFFSET ¹	Add an offset to the L1 pseudorange to compensate for signal delays

¹ Intended for advanced users of GPS only

GENERAL RECEIVER CONTROL AND STATUS	
Commands	Descriptions
\$ALMA	Download almanac data file
CRESET	Reset receiver to factory default
DYNAMICS	Set correlator tracking bandwidth
HELP	On-line command help
RESET	Performs a hardware reset (OEM only)
SAVEALMA	Saves the latest almanac in NVM
SAVECONFIG	Saves current configuration (OEM only)
\$TM1A	Injects receiver time of 1PPS
VERSION	Software/hardware information

POSITION, PARAMETERS, AND SOLUTION FILTERING CONTROL	
Commands	Descriptions
CSMOOTH ¹	Sets amount of carrier smoothing
DATUM	Choose a DATUM name type
ECUTOFF	Satellite elevation cut-off for solutions
FIX HEIGHT	Constrains to fixed height (2D mode)
FIX POSITION	Constrains to fixed lat, lon, height
FRESET	Clears all data which is stored in NVM
\$IONA	Download ionospheric correction data
IONOMODEL	What ionospheric correction to use (MiLLennium with the WAAS option)
LOCKOUT	Deweights a satellite in solutions
\$PVAA ¹	Position, velocity and acceleration in ECEF coordinates
RTKMODE	Setup the RTK mode
UNDULATION	Ellipsoid-geoid separation
USERDATUM	User-customized datum
WAASCORRECTION	Controls handling of WAAS corrections.

¹ Intended for advanced users of GPS only.

SATELLITE TRACKING AND CHANNEL CONTROL	
Commands	Descriptions
\$ALMA	Download almanac data file
ASSIGN	Satellite channel assignment
CONFIG	Switches the channel configuration of the GPSCard
DYNAMICS	Sets correlator tracking bandwidth
FIX VELOCITY	Aids high velocity reacquisition
RESETHEALTH	Reset PRN health
SETHEALTH	Overrides broadcast satellite health

WAYPOINT NAVIGATION	
Commands	Descriptions
MAGVAR	Magnetic variation correction
SETNAV	Waypoint input

DIFFERENTIAL REFERENCE STATION	
Commands	Descriptions
DGPSTIMEOUT	Sets ephemeris delay
FIX POSITION	Constrain to fixed (reference)
LOG	Selects required differential-output log
POSAVE	Implements position averaging for reference station
RTCMRULE	Selects RTCM bit rule
SETDGPSID	Set reference station ID

DIFFERENTIAL REMOTE STATION	
Commands	Descriptions
ACCEPT	Accepts RTCM1, RTCA or RTCAB differential inputs
\$ALMA	Input almanac data
DGPSTIMEOUT	Set maximum age of differential data accepted
RESET	Performs a hardware reset
\$RTCA	RTCA differential correction input (ASCII)
\$RTCM	RTCM differential correction input (ASCII)
RTCMRULE	Selects RTCM bit rule
SETDGPSID	Select differential reference station ID to receive

CLOCK INFORMATION, STATUS, AND TIME	
Commands	Descriptions
CLOCKADJUST	Enable clock modelling & 1PPS adjust
DIFF_PROTOCOL ¹	Differential protocol control
EXTERNALCLOCK	Sets default parameters of an optional external oscillator
EXTERNALCLOCK FREQUENCY	Sets clock rate
SETTIMESYNC ¹	Enable or disable time synchronization
\$UTCA	Download UTC data

1 Intended for advanced users of GPS only

Table 2-2 GPSCard Command Summary

Command	Description	Syntax
\$ALMA	Injects almanac	(follows NovAtel ASCII log format)
\$IONA	Injects ionospheric refraction corrections	(follows NovAtel ASCII log format)
\$PVAA	Injects latest computed position, velocity and acceleration	(follows NovAtel ASCII log format)
\$REPA	Injects raw GPS ephemeris data	(follows NovAtel ASCII log format)
\$RTCA	Injects RTCA format DGPS corrections in ASCII (Type 1)	(follows NovAtel ASCII log format)
\$RTCM	Injects RTCM format differential corrections in ASCII (Type 1)	(follows NovAtel ASCII log format)
\$TM1A	Injects receiver time of 1 PPS	(follows NovAtel ASCII log format)
\$UTCA	Injects UTC information	(follows NovAtel ASCII log format)
ACCEPT	Port input control (set command interpreter)	accept <i>port,option</i>
ANTENNAPOWER	Power to the low-noise amplifier of an active antenna	antennapower <i>flag</i>
ASSIGN	Assign a prn to a channel #	assign <i>channel,prn,doppler, search window</i>
UNASSIGN	Un-assign a channel	unassign <i>channel</i>
UNASSIGNALL	Un-assign all channels	unassignall
CLOCKADJUST	Disable clock steering mechanism	clockadjust <i>switch</i>
COMn	Initialize Serial Port (1 or 2)	comn <i>bps,parity,databits,stopbits, handshake,echo</i>
COMn_DTR	Programmable DTR lead/tail time	comn_dtr <i>control,active,lead,tail</i>
COMn_RTS	Programmable RTS lead/tail time	comn_rts <i>control,active,lead,tail</i>
CONFIG	Switches the channel configuration of the GPSCard	config <i>cfgtype</i>
CRESET	Configuration reset to factory default	creset
CSMOOTH	Sets carrier smoothing	csmooth <i>L1 time [L2 time]</i>
DATUM	Choose a DATUM name type	datum <i>option</i>
USERDATUM	User defined DATUM	userdatum <i>semi-major,flattening,dx,dy,dz, rx,ry,rz, scale</i>
DGPSTIMEOUT	Sets maximum age of differential data to be accepted and ephemeris delay	dgpstimeout <i>value value</i>
DIFF_PROTOCOL	Differential correction message encoding and decoding for implementation in the GPS card firmware	diff_protocol <i>type key</i> or diff_protocol <i>disable</i> or diff_protocol
DYNAMICS	Set receiver dynamics	dynamics <i>option [user_dynamics]</i>
ECUTOFF	Set elevation cutoff angle	ecutoff <i>angle</i>
EXTERNALCLOCK	Sets default parameters of an optional external oscillator	externalclock <i>option</i>
EXTERNALCLOCK FREQUENCY	Sets clock rate	external frequency <i>clock rate</i>
FIX HEIGHT	Sets height for 2D navigation	fix height <i>height [auto]</i>
FIX POSITION	Set antenna coordinates for reference station	fix position <i>lat,lon,height [station id] [health]</i>
FIX VELOCITY	Accepts INS xyz (ECEF) input to aid in high velocity reacquisition of SVs	fix velocity <i>vx,vy,vz</i>
UNFIX	Remove all receiver FIX constraints	unfix
FREQUENCY_OUT	Variable frequency output (programmable)	frequency_out <i>n,k</i>
FRESET	Clears all data which is stored in non-volatile memory	freset
HELP or ?	On-line command help	help <i>option</i> or ? <i>option</i>
IONOMODEL	Influences what ionospheric corrections the card uses	ionomodel <i>keyword</i>
LOCKOUT	Lock out satellite	lockout <i>prn</i>
UNLOCKOUT	Restore satellite	unlockout <i>prn</i>
UNLOCKOUTALL	Restore all satellites	unlockoutall
LOG	Choose data logging type	log <i>[port],datatype,[trigger],[period],[offset],[hold]</i>
UNLOG	Disable a data log	unlog <i>[port],data type</i>
UNLOGALL	Disable all data logs	unlogall <i>[port]</i>
MAGVAR	Set magnetic variation correction	magvar <i>value</i>
MESSAGES	Disable error reporting from command interpreter	messages <i>port,option</i>
POSAVE	Implements position averaging for reference station	posave <i>maxtime, maxhorstd, maxverstd</i>
RESET	Performs a hardware reset (OEM only)	reset

RINEX	Configure the user defined fields in the file headers	<i>rinex cfgtype</i>
RTCM16T	Enter an ASCII text message to be sent out in the RTCM data stream	<i>rtcm16t ascii message</i>
RTCMRULE	Set variations of the RTCM bit rule	<i>rtcmrule rule</i>
RTKMODE	Set up the RTK mode	<i>rtkmode argument, data range</i>
SAVEALMA	Save the latest almanac in non-volatile memory	<i>savealma option</i>
SAVECONFIG	Save current configuration in non-volatile memory (OEM only)	<i>saveconfig</i>
SEND	Send an ASCII message to any of the communications ports	<i>send port ascii-message</i>
SENDHEX	Sends non-printable characters in hexadecimal pairs	<i>sendhex port data</i>
SETDGPSID	Enter in a reference station ID	<i>setdgpsid option</i>
SETHEALTH	Override PRN health	<i>sethealth prn,health</i>
RESETHEALTH	Reset PRN health	<i>resethealth prn</i>
RESETHEALTHALL	Reset all PRN health	<i>resethealthall</i>
SETL1OFFSET	Add an offset to the L1 pseudorange to compensate for signal delays	<i>setL1offset distance</i>
SETNAV	Set a destination waypoint	<i>setnav from lat,from lon,to lat, to lon,track offset, from port,to port</i>
SETTIMESYNC	Enable or disable time synchronization	<i>settimesync flag</i>
UNDULATION	Choose undulation	<i>undulation separation</i>
VERSION	Current software and hardware information	<i>version</i>
WAASCORRECTION	Dictates how the card handles WAAS/EGNOS corrections	<i>waascorrection keyword [prn] [mode]</i>

Table 3-1 Logs By Function Table

COMMUNICATIONS, CONTROL AND STATUS	
Logs	Descriptions
CDSA/B	COM port communications status
COM1A/B	Log data from COM1
COM2A/B	Log data from COM2
COMnA/B	Pass-through data logs
RCSA/B	Receiver self-test status
RTCM16T	NovAtel ASCII format special message
RTCM16	RTCM format special message

GENERAL RECEIVER CONTROL AND STATUS	
Logs	Descriptions
PVAA/B	Receiver's latest computed position, velocity and acceleration in ECEF coordinates
RCCA	Receiver configuration status
RCSA/B	Version and self-test status
RVSA/B	Receiver status
VERA/B	Receiver hardware and software version numbers

POSITION, PARAMETERS, AND SOLUTION FILTERING CONTROL	
Logs	Descriptions
DOPA/B	DOP of SVs currently tracking
GGAB	GPS fix data
GPGGA	NMEA, position data
GPGLL	NMEA, position data
GPGRS	NMEA, range residuals
GPGSA	NMEA, DOP information
GPGST	NMEA, measurement noise statistics
MKPA/B	Position at time of mark
POSA/B	Position data
PRTKA/B	Computed position
PVAA/B	Computed position, velocity and acceleration in ECEF coordinates
PXYA/B	Position (Cartesian x,y,z coordinates)
RTKA/B	Computed position
SPHA/B	Speed and direction over ground

SATELLITE TRACKING AND CHANNEL CONTROL	
Logs	Descriptions
ALMA/B	Current decoded almanac data
DOPA/B	DOP of SVs currently tracking
ETSA/B	Provides channel tracking status information for each of the GPSCard parallel channels
GPALM	NMEA, almanac data
GPGSA	NMEA, SV DOP information
GPGSV	NMEA, satellite-in-view information
RALA/B	Raw almanac
RASA/B	Raw GPS almanac set
RGEA/B/D	Satellite range measurements
SATA/B	Satellite specific information
SBTA/B	Satellite broadcast data (raw symbols)
SVDA/B	SV position (ECEF xyz)
WALA/B	WAAS almanac
WRCA/B	Wide band range correction data (grouped format)

WAYPOINT NAVIGATION	
Logs	Descriptions
GPRMB	NMEA, waypoint status
GPRMC	NMEA, navigation information
GPVTG	NMEA, track made good and speed
GPZTG	NMEA, time to destination
MKPA/B	Position at time of mark input
NAVA/B	Navigation waypoint status
POSA/B	Position data
SPHA/B	Speed and course over ground
VLHA/B	Velocity, latency & direction over ground

DIFFERENTIAL REFERENCE STATION	
Logs	Descriptions
ALMA/B	Current almanac information
CDSA/B	COM port data transmission status
CMR	Pseudorange and carrier phase data
PAVA/B	Parameters being used in the position averaging process
RGEA/B/D	Channel range measurements
RPSA/B	Reference station position and health
RTCAA/B	Transmits RTCA differential corrections in NovAtel ASCII or Binary
RTCM1	Transmits RTCM SC104 standard corrections
RTCM3	Reference position
RTCM1819	Uncorrected carrier phase and pseudorange measurements
RTCM22	Extended reference station parameters
RTCM59	NovAtel format RT-20 observation data
RTCMA/B	Transmits RTCM information in NovAtel ASCII/binary
SATA/B	Satellite specific information

DIFFERENTIAL REMOTE STATION	
Logs	Descriptions
CDSA/B	Communication and differential decode status
GPGGA	NMEA, position fix data
GGAB	NovAtel binary version of GPGGA
POSA/B	Position information
PRTKA/B	Computed Position – best available
RTKA/B	Computed Position – Time Matched
RTKOA/B	RTK Output
SATA/B	Satellite specific information
SVDA/B	SV position in ECEF XYZ with corrections
VLHA/B	Velocity, latency & direction over ground

POST PROCESSING DATA	
Logs	Descriptions
BSLA/B	Most recent matched baseline expressed in ECEF coords.
CLKA/B	Receiver clock offset information
REPA/B	Raw ephemeris information
RGEA/B/D	Satellite and ranging information
SATA/B	Satellite specific information
SVDA/B	SV position in ECEF XYZ with corrections
WEPA/B	WAAS ephemeris information



CLOCK INFORMATION, STATUS, AND TIME	
Logs	Descriptions
CLKA/B	Receiver clock offset information
CLMA/B ¹	Current clock-model matrices of the GPSCard
GPZDA	NMEA, UTC time and date
GPZTG	NMEA, UTC and time to waypoint
MKTA/B	Time of mark input
TM1A/B	Time of 1PPS
WUTCA/B	WAAS, UTC parameters

¹ Intended for advanced users of GPS only.

NAVIGATION DATA	
Logs	Descriptions
FRMA/B	Framed raw navigation data
RALA/B	Raw almanac and health data
RASA/B	Raw almanac set
RBTA/B	Satellite broadcast data in raw bits
REPA/B	Raw ephemeris data

Table 3-2 GPSCard Log Summary

Syntax: **log port,datatype,[trigger],[period],[offset],[hold]**

NovAtel Format Logs			
Datatype	Description	Datatype	Description
ALMA/B	Decoded Almanac	RCCA	Receiver Configuration
BSLA/B	Baseline Measurement	RCSA	Receiver Status
CDSA/B	Communication and Differential Decode Status	REPA/B	Raw Ephemeris
CLKA/B	Receiver Clock Offset Data	RGEA/B/D	Channel Range Measurements
CLMA/B	Receiver Clock Model	RPSA/B	Reference Station Position and Health
COM1A/B	Log data from COM1	RTCAA/B	RTCA format Differential Corrections with NovAtel headers
COM2A/B	Log data from COM2	RTKA/B	Computed Position - Time Matched
DOPA/B	Dilution of Precision	RTKOA/B	RTK Solution Parameters
ETSA/B	Extended Tracking Status	RTCMA/B	RTCM Type 1 Differential Corrections with NovAtel headers
FRMA/B	Framed Raw Navigation Data	RTCM16I	Special Message
GGAB	Global Position System Fix Data - Binary Format	RVSA/B	Receiver Status
MKPA/B	Mark Position	SATA/B	Satellite Specific Data
MKTA/B	Time of Mark Input	SBTA/B	Satellite Broadcast Data (Raw Symbols)
NAVA/B	Navigation Data	SPHA/B	Speed and Direction Over Ground
PAVA/B	Positioning Averaging Status	SVDA/B	SV Position in ECEF XYZ Coordinates with Corrections
POSA/B	Computed Position	TMTA/B	Time of 1PPS
PRTKA/B	Computed Position	VERA/B	Receiver Hardware and Software Version Numbers
PVAA/B	XYZ Position, Velocity and Acceleration	VLHA/B	Velocity, Latency, and Direction over Ground
PXYA/B	Computed Cartesian Coordinate Position	WALA/B	WAAS Almanac
RALA/B	Raw Almanac	WEPA/B	WAAS Ephemeris
RASA/B	Raw GPS Almanac Set	WRCA/B	Wide Band Range Correction (Grouped)
RBTA/B	Satellite Broadcast Data: Raw Bits	WUTCA/B	WAAS, UTC Time Parameters
NMEA Format Logs			
GPALM	Almanac Data	GPGSV	GPS Satellites in View
GPGGA	Global Position System Fix Data	GPRMB	Generic Navigation Information
GPGLL	Geographic Position - lat/lon	GPRMC	GPS Specific Information
GPGRS	GPS Range Residuals for Each Satellite	GPVTG	Track Made Good and Ground Speed
GPGSA	GPS DOP and Active Satellites	GPZDA	UTC Time and Date
GPGST	Pseudorange Measurement Noise Statistics	GPZTG	UTC & Time to Destination Waypoint
RTCA Format			
RTCA	RTCA Differential Corrections: Type 1 and Type 7		
RTCM Format			
RTCM1	Type 1 Differential GPS Corrections		
RTCM3	Type 3 Reference Station Parameters		
RTCM9	Type 9 Partial Satellite Set Differential Corrections		
RTCM16	Type 16 Special Message		
RTCM1819	Type 18 and Type 19 Uncorrected Carrier Phase and Pseudorange Corrections		
RTCM22	Type 22 Extended Reference Station Parameters		
RTCM59	Type 59N-0 NovAtel Proprietary Message: RT20 Differential Observations		

Note A/B/D:

- A refers to GPSCard output logs in ASCII format.
- B refers to GPSCard output logs in Binary format.
- D refers to GPSCard output logs in compressed binary format.

Table 4-1 Positioning Modes

	Reference station: L1 RTCM Type 59N	Reference station: L1 RTCA Type 7	Reference station: L1 & L2 RTCM Type 59N	Reference station: L1 & L2 RTCA Type 7
Remote station: L1	RT-20	RT-20	RT-20	RT-20
Remote station: L1 & L2	RT-20	RT-20	RT-20	RT-2

Table C-1 Antenna LNA Power Configuration

	P301: plug connects pins 1&2	P301: plug connects pins 2&3	P301: no plug
ANTENNAPOWER = ON	internal power connected to LNA	no external effect	no external effect
ANTENNAPOWER = OFF	internal power cut off from LNA	no external effect	no external effect

Table C-2 Default Values of Process Noise Elements

Timing Standard	h_0	h_{-1}	h_{-2}
VCTCXO	1.0 e-21	1.0 e-20	2.0 e-20
OCXO	2.51 e-26	2.51 e-23	2.51 e-22
rubidium	1.0 e-23	1.0 e-22	1.3 e-26
cesium	2.0 e-20	7.0 e-23	4.0 e-29
user (min / max)	$1.0 \text{ e-}31 \leq h_0 \leq 1.0 \text{ e-}18$	$1.0 \text{ e-}31 \leq h_{-1} \leq 1.0 \text{ e-}18$	$1.0 \text{ e-}31 \leq h_{-2} \leq 1.0 \text{ e-}18$

Table C-3 VARF Range (Software Version 4.42 or higher)

n	k	p	VARF (Hz)
1	1	1	0 (Minimum)
1024	65 536	65 536	0.004 652 065
1	65 536	65 536	0.004 656 612
1	4000	5000	1
2	4	8	312 500
1	2	2	5 000 000 (Maximum)

Table D-1 GPSCard Solution Status

Value	Description
0	Solution computed
1	Insufficient observations
2	No convergence
3	Singular $A^T P A$ Matrix
4	Covariance trace exceeds maximum (trace > 1000 m)
5	Test distance exceeded (maximum of 3 rejections if distance > 10 km)
6	Not yet converged from cold start
7	Height or velocity limit exceeded. (In accordance with COCOM export licensing restrictions)

Higher numbers are reserved for future use

Table D-2 Position Type

Type	Definition
0	No position
1	Single point position
2	Differential pseudorange position
3	RT-20 position
4	RT-2 position
5	WAAS position solution

Higher numbers are reserved for future use

Table D-3 RTK Status for Position Type 3 (RT-20)

Status	Definition
0	Floating ambiguity solution (converged)
1	Floating ambiguity solution (not yet converged)
2	Modelling reference phase
3	Insufficient observations
4	Variance exceeds limit
5	Residuals too big
6	Delta position too big
7	Negative variance
8	RTK position not computed

Higher numbers are reserved for future use

Table D-4 RTK Status for Position Type 4 (RT-2)

Status	Definition
0	Narrow lane solution
1	Wide lane derived solution
2	Floating ambiguity solution (converged)
3	Floating ambiguity solution (not yet converged)
4	Modeling reference phase
5	Insufficient observations
6	Variance exceeds limit
7	Residuals too big
8	Delta position too big
9	Negative variance
10	RTK position not computed
11	Narrow lane solution - high standard deviation ^a
12	Widelane solution - high standard deviation ^b

c

- a. > 30 cm 3-D standard deviation
- b. > 50 cm 3-D standard deviation
- c. Higher numbers are reserved for future use



Table D-5 Receiver Self-Test Status Codes

N7	N 6				N 5				N 4				N 3				N 2				N 1				N 0				Bit	Description	Range Values	Hex Value
27	26	25	24	23	22	21	20	19	18	17	16	15	14	13	12	11	10	9	8	7	6	5	4	3	2	1	0					
																												1sb = 0	ANTENNA	1=good, 0=bad	00000001	
																												1	L1 PLL	1=good, 0=bad	00000002	
																												2	RAM	1=good, 0=bad	00000004	
																												3	ROM	1=good, 0=bad	00000008	
																												4	DSP	1=good, 0=bad	00000010	
																												5	L1 AGC	1=good, 0=bad	00000020	
																												6	COM1	1=good, 0=bad	00000040	
																												7	COM2	1=good, 0=bad	00000080	
																												8	WEEK	1=not set, 0=set	00001000	
																												9	NO COARSETIME	1=not set, 0=set	00002000	
																												10	NO FINE TIME	1=not set, 0=set	00004000	
																												11	L1 JAMMER	1=present, 0=normal	00008000	
																												12	BUFFER COM1	1=overrun, 0=normal	00010000	
																												13	BUFFER COM2	1=overrun, 0=normal	00020000	
																												14	BUFFER CONSOLE	1=overrun, 0=normal	00040000	
																												15	CRU OVERLOAD	1=overload, 0=normal	00080000	
																												16	ALMANAC SAVED IN NVM	1=yes, 0=no	00100000	
																												17	L2 AGC	1=good, 0=bad	00200000	
																												18	L2 JAMMER	1=present, 0=normal	00400000	
																												19	L2 PLL	1=good, 0=bad	00800000	
																												20	OCD PLL	1=good, 0=bad	01000000	
																												21	SAVED ALMA NEEDS UPDATE	1=yes, 0=no	02000000	
																												22	ALMANAC INVALID	1=invalid, 0=valid	04000000	
																												23	POSITION SOLUTION INVALID	1=invalid, 0=valid	08000000	
																												24	POSITION FIXED	1=yes, 0=no	01000000	
																												25	CLOCK MODEL INVALID	1=invalid, 0=valid	02000000	
																												26	CLOCK STEERING DISABLED	1=disabled, 0=enabled	04000000	
																												27	RESERVED			
																												28-31	RESERVED			

Notes on Table D-5:

1. **Bit 3:** On OEM GPSCards, “ROM” includes all forms of non-volatile memory.
2. **Bits 12-15:** Flag is reset to 0 five minutes after the last overrun/overload condition has occurred.

Table D-6 Range Record Format (RGED only)

Data	Bit(s) from first to last	Length (bits)	Format	Scale Factor	
PRN	1A, 1B	0..5	6	integer	1
C/No	2	6..10	5	integer	(20+n) dB-Hz
Lock time	3	11.31	21	integer	1/32 s
ADR	4	32..63	32	integer 2's comp.	1/256 cycles
Doppler frequency		68..95	28	integer 2's comp.	1/256 Hz
Pseudorange		64..67 msn; 96..127 lsw	36	integer 2's comp.	1/128 m
StdDev - ADR		128..131	4	integer	(n+1) / 512 cyc
StdDev - pseudorange		132..135	4		see ⁵
Channel Tracking status ⁶		136..159	24	integer	see Table D-7, Page 203

Notes on Table D-6:

- 1A Only PRNs 1 - 63 are reported correctly (Note: while there are only 32 PRNs in the basic GPS scheme, situations exist which require the use of additional PRNs)
- 1B The prn offsets for WAAS have been mapped to the same range as GPS, i.e. 1 - 19, while the prn offsets for GLONASS are 1 - 29.
- 2 C/No is constrained to a value between 20 - 51 dB-Hz. Thus, if it is reported that C/No = 20 dB-Hz, the actual value could be less. Likewise, if it is reported that C/No = 51 dB-Hz, the true value could be greater.
- 3 Lock time rolls over after 2,097,151 seconds.
- 4 ADR (Accumulated Doppler Range) is calculated as follows:

$$ADR_ROLLS = (-RGED_PSR / WAVELENGTH - RGED_ADR) / MAX_VALUE$$

Round to the closest integer

IF (ADR_ROLLS ≤ -0.5)

$$ADR_ROLLS = ADR_ROLLS - 0.5$$

ELSE

$$ADR_ROLLS = ADR_ROLLS + 0.5$$

At this point integerise ADR_ROLLS

$$CORRECTED_ADR = RGED_ADR - (MAX_VALUE * ADR_ROLLS)$$

where:

ADR has units of cycles

WAVELENGTH = 0.1902936727984 for L1

WAVELENGTH = 0.2442102134246 for L2

MAX_VALUE = 8388608



5

Code	RGED
0	0.000 to 0.050
1	0.051 to 0.075
2	0.076 to 0.113
3	0.114 to 0.169
4	0.170 to 0.253
5	0.254 to 0.380
6	0.381 to 0.570
7	0.571 to 0.854
8	0.855 to 1.281
9	1.282 to 2.375
10	2.376 to 4.750
11	4.751 to 9.500
12	9.501 to 19.000
13	19.001 to 38.000
14	38.001 to 76.000
15	76.001 to 152.000

6 Only bits 0 - 23 are represented in the RGED log

Table D-7 Channel Tracking Status

N 7 N 6 N 5 N 4 N 3 N 2 N 1 N 0 <<< Nibble Number												Bit	Description	Range Values	Hex.
												lsb = 0			1
												1	Tracking state	0 - 11 See below	2
												2			4
												3			8
												4			10
												5	SV channel number	0 - n (0 = first, n = last) (n depends on GPSCard)	20
												6			40
												7			80
												8			100
												9	Phase lock flag	1 = Lock, 0 = Not locked	200
												10	Parity known flag	1 = Known, 0 = Not known	400
												11	Code locked flag	1 = Lock, 0 = Not locked	800
												12			1000
												13	Correlator spacing	0 - 7 See below	2000
												14			4000
												15	Satellite system	0=GPS 3=Pseudolite 1=GLONASS 4-7 Reserved 2=WAAS	8000
												16			10000
												17			20000
												18	Reserved		40000
												19	Grouping *	1 = Grouped, 0 = Not grouped	80000
												20	Frequency	1 = L2, 0 = L1	100000
												21	Code type	0 = C/A 2 = P-codeless 1 = P 3 = Reserved	200000
												22			400000
												23	Forward error correction	1 = FEC enabled, 0 = no FEC	800000
												24	Reserved		
												25			
												26			
												27			
												28			
												29			
												30	External range	1 = Ext. range, 0 = Int. range	
31	Channel assignment	1 = Forced, 0 = Automatic													

* Grouped: A channel has an associated channel (L1/L2 pairs in MiLLennium and L1/L1 pairs in Beeline)

Table D-7 is referenced by the ETSA/B, and RGEA/B/D logs.

Table D-7, Bits 0 - 3: Channel Tracking State

State	Description	State	Description
0	L1 Idle	6	L1 Steering
1	L1 Sky search	7	L1 Frequency-lock loop
2	L1 Wide frequency band pull-in	8	L2 Idle
3	L1 Narrow frequency band pull-in	9	L2 P-code alignment
4	L1 Phase-lock loop	10	L2 Search
5	L1 Re-acquisition	11	L2 Phase-lock loop

Higher numbers are reserved for future use

Table D-7, Bits 12-14: Correlator Spacing

State	Description
0	Unknown: this only appears in versions of software previous to x.45, which didn't use this field
1	Standard correlator: spacing = 1 chip
2	Narrow Correlator tracking technology: spacing < 1 chip

Higher numbers are reserved for future use

Table D-8 Ambiguity Types

Ambiguity Type	Definition
0	L1 only floating
1	Wide lane fixed integer
2	Reserved
3	Narrow lane floating
4	Iono-free floating
5	Reserved
6	Narrow lane fixed integer
7	Iono-free fixed discrete
8	L1 only fixed integer
9	Reserved
10	Undefined type

Higher numbers are reserved for future use

Table D-9 Searcher Status

Searcher Status	Definition
0	No search requested
1	Searcher buffering measurements
2	Currently searching
3	Search decision made
4	Hand-off to L1 and L2 complete

Higher numbers are reserved for future use

Table D-10 RTK Status

RTK Status	Definition
1	Good narrowlane solution
2	Good widelane solution
4	Good L1/L2 converged float solution
8	Good L1/L2 unconverged float solution
16	Good L1 converged solution
32	Good L1 unconverged solution
64	Reserved for future use
128	Insufficient observations
256	Variance exceeds limit
512	Residuals exceed limit
1024	Delta position too large
2048	Negative variance
4096	Undefined
8192	RTK initialize

Higher numbers are reserved for future use

Table D-11 GPSCard Range Reject Codes

Value	Description
0	Observations are good
1	Bad satellite health is indicated by ephemeris data
2	Old ephemeris due to data not being updated during last 3 hours
3	Eccentric anomaly error during computation of the satellite's position
4	True anomaly error during computation of the satellite's position
5	Satellite coordinate error during computation of the satellite's position
6	Elevation error due to the satellite being below the cutoff angle
7	Misclosure too large due to excessive gap between estimated and actual positions
8	No differential correction is available for this particular satellite
9	Ephemeris data for this satellite has not yet been received
10	Invalid IODE due to mismatch between differential stations
11	Locked Out: satellite is excluded by user (LOCKOUT command)
12	Low Power: satellite rejected due to low signal/noise ratio
13	L2 measurements are not currently used in the filter

Higher numbers are reserved for future use

Table D-12 GPSCard Velocity Status

Value	Description
0	Velocity computed from differentially corrected carrier phase data
1	Velocity computed from differentially corrected Doppler data
2	Old velocity from differentially corrected phase or Doppler (higher latency)
3	Velocity from single point computations
4	Old velocity from single point computations (higher latency)
5	Invalid velocity

Higher numbers are reserved for future use

Table E-1 Comparison of RT-2 and RT-20

	RT-2	RT-20
GPS Frequencies Utilized	L1 & L2	L1
Nominal Accuracy	2 cm (CEP)	20 cm (CEP)
Lane Searching	Wide lane and narrow lane	None

Table E-2 RTK Messages Vs. Accuracy

Transmitting (Reference)	Receiving (Remote)	Accuracy Expected
GPSCard transmitting RTCA (i.e. RTCAOBS and RTCAREF)	RT-2 receiver	2 centimetre CEP
	RT-20 receiver	20 centimetre CEP
GPSCard transmitting RTCM type 3 and 59	RT-2 receiver	20 centimetre CEP
	RT-20 receiver	20 centimetre CEP
GPSCard transmitting RTCM or RTCA type 1	RT-2 receiver	1 metre SEP
	RT-20 receiver	1 metre SEP
Transmitting RTCM type 18 and 19 with type 3	RT-2 receiver	2 centimetre CEP
	RT-20 receiver	20 centimetre CEP
Transmitting CMR (i.e. CMROBS and CMRREF)	RT-2 receiver	2 centimetre CEP
	RT-20 receiver	20 centimetre CEP

Table E-3 RT-2 Performance: Static Mode

Baseline length	Time since L2 lock-on with at least 6 satellites above mask angle	Horizontal accuracy at the stated time	Runs meeting the stated accuracy at the stated time
< 10 km	70 seconds + 1.5 sec/km	2 cm + 0.5 ppm	75.0%
< 10 km	5 minutes	1 cm + 1 ppm	75.0%
< 15 km	4 minutes	5 cm	66.7%
< 25 km	7 minutes	7 cm	66.7%
< 35 km	10 minutes	35 cm	66.7%
< 35 km	30 minutes	25 cm	66.7%

Table E-4 RT-2 Performance: Kinematic Mode

Baseline length	Time since L2 lock-on with at least 6 satellites above mask angle	Horizontal accuracy at the stated time	Runs meeting the stated accuracy at the stated time
< 10 km	120 seconds + 1.5 sec/km	2 cm + 0.5 ppm	75.0%
< 15 km	8 minutes	8 cm	66.7%
< 25 km	14 minutes	10 cm	66.7%
< 35 km	20 minutes	40 cm	66.7%
< 35 km	60 minutes	25 cm	66.7%

Table E-5 RT-2 Degradation With Respect To Data Delay ¹

Data Delay (sec)	Distance (km)	Accuracy (CEP)
0 - 2	1	+1 cm/sec
2 - 7	1	+2 cm/sec
7 - 30	1	+5 cm/sec
> 30	1	pseudorange or single point ³

Table E-6 RT-20 Performance

Tracking Time (sec)	Mode ¹	Data Delay (sec)	Distance (km)	Accuracy (CEP)
1 - 180	Static	0	1	100 to 25 cm
180 - 3000	Static	0	1	25 to 5 cm
> 3000	Static	0	1	5 cm or less ²
1 - 600	Kinematic	0	1	100 to 25 cm
600 - 3000	Kinematic	0	1	25 to 5 cm
> 3000	Kinematic	0	1	5 cm or less ²
	Either	0 - 2	1	+1 cm/sec
	Either	2 - 7	1	+2 cm/sec
	Either	7 - 30	1	+5 cm/sec
	Either	> 30	1	pseudorange or single point ³

¹ Mode = Static or Kinematic

² The accuracy specifications refer to the PRTKA/B logs which include about 3 cm extrapolation error. RTKA/B logs are more accurate but have increased latency associated with them.

³ After 30 seconds reverts to pseudorange positioning (single point or differential depending on messages previously received from the base station).

K**GPS GLOSSARY OF TERMS**

ASCII	A 7-bit wide serial code describing numbers, upper and lower case characters, special and non-printing characters. Typically used for textual data.
Acquisition	The process of locking onto a satellite's C/A code and P code. A receiver acquires all available satellites when it is first powered up, then acquires additional satellites as they become available and continues tracking them until they become unavailable.
Address Field	For sentences in the NMEA standard, the fixed length field following the beginning sentence delimiter "\$" (HEX 24). For NMEA approved sentences, composed of a two character talker identifier and a three character sentence formatter. For proprietary sentences, composed of the character "P" (HEX 50) followed by a three character manufacturer identification code.
Almanac	A set of orbit parameters that allows calculation of approximate GPS satellite positions and velocities. The almanac is used by a GPS receiver to determine satellite visibility and as an aid during acquisition of GPS satellite signals.
Almanac Data	A set of data which is downloaded from each satellite over the course of 12.5 minutes. It contains orbital parameter approximations for all satellites, GPS to universal standard time (UTC) conversion parameters, and single-frequency ionospheric model parameters.
Anti-Spoofing	Denial of the P-code by the Control Segment is called Anti-Spoofing. It is normally replaced by encrypted Y-code, [see <i>P-Code</i> and <i>Y-Code</i>]
Attenuation	Reduction of signal strength
Azimuth	The horizontal direction of a celestial point from a terrestrial point, expressed as the angular distance from 000° (reference) clockwise through 360°. The reference point is generally True North, but may be Magnetic North, or Relative (ship's head).
Bearing	The horizontal direction of one terrestrial point from another terrestrial point, expressed as the angular distance from a reference direction, usually measured from 000° at the reference direction clockwise through 360°. The reference point may be True North, Magnetic North, or Relative (ship's head).
Carrier	The steady transmitted RF signal whose amplitude, frequency, or phase may be modulated to carry information.
Carrier Phase Ambiguity	The number of integer carrier phase cycles between the user and the satellite at the start of tracking. (Sometimes ambiguity for short)
Carrier Phase Measurements	These are "accumulated doppler range" (ADR) measurements. They contain the instantaneous phase of the signal (modulo 1 cycle) plus some arbitrary number of integer cycles. Once the receiver is tracking the satellite, the integer number of cycles correctly accumulates the change in range seen by the receiver. When a "lock break" occurs, this accumulated value can jump an arbitrary integer number of cycles (this is called a cycle slip).
Checksum	By NMEA standard, a validity check performed on the data contained in the sentences, calculated by the talker, appended to the message, then recalculated by the listener for comparison to determine if the message was received correctly. Required for some sentences, optional for all others.
Circular Error Probable (CEP)	Circular error probable; the radius of a circle such that 50% of a set of events occur inside the boundary.
Coarse Acquisition (C/A) Code	A pseudorandom string of bits that is used primarily by commercial GPS receivers to determine the range to the transmitting GPS satellite. The 1023 chip C/A code repeats every 1 ms giving a code chip length of 300 m which, is very easy to lock onto.

Communication Protocol	A method established for message transfer between a talker and a listener which includes the message format and the sequence in which the messages are to be transferred. Also includes the signalling requirements such as bit rate, stop bits, parity, and bits per character.
Control Segment	The Master Control Station and the globally dispersed Reference Stations used to manage the GPS satellites, determine their precise orbital parameters, and synchronize their clocks.
Coordinated Time (UTC)	This time system uses the second-defined true angular rotation of the Earth Universal measured as if the Earth rotated about its Conventional Terrestrial Pole. However, UTC is adjusted only in increments of one second. The time zone of UTC is that of Greenwich Mean Time (GMT).
Course	The horizontal direction in which a vessel is to be steered or is being steered; the direction of travel through the air or water. Expressed as angular distance from reference North (either true, magnetic, compass, or grid), usually 000° (north), clockwise through 360°. Strictly, the term applies to direction through the air or water, not the direction intended to be made good over the ground [see <i>Track</i>]. Differs from heading.
Course Made Good (CMG)	The single resultant direction from a given point of departure to a subsequent position; the direction of the net movement from one point to the other. This often varies from the track caused by inaccuracies in steering, currents, cross-winds, etc. This term is often considered to be synonymous with Track Made Good, however, Course Made Good is the more correct term.
Course Over Ground (COG)	The actual path of a vessel with respect to the Earth (a misnomer in that courses are directions steered or intended to be steered through the water with respect to a reference meridian); this will not be a straight line if the vessel's heading yaws back and forth across the course.
Cross Track Error (XTE)	The distance from the vessel's present position to the closest point on a great Circle line connecting the current waypoint coordinates. If a track offset has been specified in the GPSCard SETNAV command, the cross track error will be relative to the offset track great circle line.
Cycle Slip	When the carrier phase measurement jumps by an arbitrary number of integer cycles. It is generally caused by a break in the signal tracking due to shading or some similar occurrence.
Dead Reckoning (DR)	The process of determining a vessel's approximate position by applying from its last known position a vector or a series of consecutive vectors representing the run that has since been made, using only the courses being steered, and the distance run as determined by log, engine rpm, or calculations from speed measurements.
Destination	The immediate geographic point of interest to which a vessel is navigating. It may be the next waypoint along a route of waypoints or the final destination of a voyage.
Differential GPS (DGPS)	A technique to improve GPS accuracy that uses pseudorange errors at a known location to improve the measurements made by other GPS receivers within the same general geographic area.

Dilution of Precision (DOP)	A numerical value expressing the confidence factor of the position solution based on current satellite geometry. The lower the value, the greater the confidence in the solution. DOP can be expressed in the following forms. GDOP - uncertainty of all parameters (latitude, longitude, height, clock offset) PDOP - uncertainty of 3D parameters (latitude, longitude, height) HTDOP - uncertainty of 2D and time parameters (latitude, longitude, time) HDOP - uncertainty of 2D parameters (latitude, longitude) VDOP - uncertainty of height parameter TDOP - uncertainty of clock offset parameter
Doppler	The change in frequency of sound, light or other wave caused by movement of its source relative to the observer.
Doppler Aiding	A signal processing strategy, which uses a measured Doppler shift to help a receiver smoothly track the GPS signal, to allow more precise velocity and position measurement.
Double-Difference	A mathematical technique comparing observations by differencing between receiver channels and then between the reference and rover receivers.
Double-Difference Carrier Phase Ambiguity	Carrier phase ambiguities which are differenced between receiver channels and between the reference and rover receivers. They are estimated when a double-difference mechanism is used for carrier phase positioning. (Sometimes double-difference ambiguity or ambiguity, for short)
Earth-Centred Earth-Fixed (ECEF)	This is a coordinate-ordinate system which has the X-coordinate in the earth's equatorial plane pointing to the Greenwich prime meridian, the Z-axis pointing to the north pole, and the Y-axis in the equatorial plane 90° from the X-axis with an orientation which forms a right-handed XYZ system.
Elevation	The angle from the horizon to the observed position of a satellite.
Ellipsoid	A smooth mathematical surface which represents the earth's shape and very closely approximates the geoid. It is used as a reference surface for geodetic surveys, refer to the RTKA/B log on <i>Page 207</i> .
Ellipsoidal Height	Height above a defined ellipsoid approximating the surface of the earth.
Ephemeris	A set of satellite orbit parameters that are used by a GPS receiver to calculate precise GPS satellite positions and velocities. The ephemeris is used in the determination of the navigation solution and is updated periodically by the satellite to maintain the accuracy of GPS receivers.
Ephemeris Data	The data downlinked by a GPS satellite describing its own orbital position with respect to time.
Epoch	Strictly a specific point in time. Typically when an observation is made.
Field	A character or string of characters immediately preceded by a field delimiter.
Fixed Ambiguity Estimates	Carrier phase ambiguity estimates which are set to a given number and held constant. Usually they are set to integers or values derived from linear combinations of integers.
Fixed Discrete Ambiguity Estimates	Carrier phase ambiguities which are set to values which are members of a predetermined set of discrete possibilities, and then held constant.
Fixed Field	A field in which the number of characters is fixed. For data fields, such fields are shown in the sentence definitions with no decimal point. Other fields which fall into this category are the address field and the checksum field (if present).
Fixed Integer	Carrier phase ambiguities which are set to integer values and then held

Ambiguity Estimates	constant.
Flash ROM	Programmable read-only memory.
Floating Ambiguity Estimates	Ambiguity estimates which are not held to a constant value, but are allowed to gradually converge to the correct solution.
Geometric Dilution of Precision (GDOP)	[See <i>DOP</i>]
Geoid	The shape of the earth if it were considered as a sea level surface extended continuously through the continents. The geoid is an equipotential surface coincident with mean sea level to which at every point the plumb line (direction in which gravity acts) is perpendicular. The geoid, affected by local gravity disturbances, has an irregular shape.
Geodetic Datum	The reference ellipsoid surface that defines the coordinate system.
Geostationary	A satellite orbit along the equator that results in a constant fixed position over a particular reference point on the earth's surface. (GPS satellites are not geostationary.)
Global Positioning System (GPS)	Full name is NAVSTAR Global Positioning System. A space-based radio Positioning system which provides suitably equipped users with accurate position, velocity and time data. GPS provides this data free of direct user charge worldwide, continuously, and under all weather conditions. The GPS constellation consists of 24 orbiting satellites, four equally spaced around each of six different orbital planes. The system is being developed by the Department of Defence under U.S. Air Force management.
Great Circle	The shortest distance between any two points along the surface of a sphere or ellipsoid, and therefore the shortest navigation distance between any two points on the Earth. Also called Geodesic Line.
Handshaking	Predetermined hardware or software activity designed to establish or maintain two machines or programs in synchronization. Handshaking concerns the exchange of messages or packets of data between two systems with limited buffers. Hardware handshaking uses voltage levels or pulses in wires to carry the handshaking signals. Software handshaking uses data units (e.g. ASCII characters) carried by some underlying communication medium.
Horizontal Dilution of Precision (HDOP)	[See <i>DOP</i>]
Horizontal and Time Dilution of Precision (HTDOP)	[See <i>DOP</i>]
Heading	The direction in which a vessel points or heads at any instant, expressed in degrees 000° clockwise through 360° and may be referenced to True North, Magnetic North, or Grid North. The heading of a vessel is also called the ship's head. Heading is a constantly changing value as the vessel oscillates or yaws across the course due to the effects of the air or sea, cross currents, and steering errors.
Integer Ambiguity Estimates	Carrier phase ambiguity estimates which are only allowed to take on integer values.
Iono-Free Carrier Phase Observation	A linear combination of L1 and L2 carrier phase measurements which provides an estimate of the carrier phase observation on one frequency with the effects of the ionosphere removed. It provides a different ambiguity value (non-integer) than a simple measurement on that frequency.
Kinematic	The user's GPS antenna is moving. In GPS, this term is typically used with precise carrier phase positioning, and the term dynamic is used with pseudorange positioning.

L1 Frequency	The 1575.42 MHz GPS carrier frequency which contains the course acquisition (C/A) code, as well as encrypted P-code, and navigation messages used by commercial GPS receivers.
L2 Frequency	The 1227.60 MHz. secondary GPS carrier frequency, containing only encrypted P-code, used primarily to calculate signal delays caused by the ionosphere.
Lane	A particular discrete ambiguity value on one carrier phase range measurement or double difference carrier phase observation. The type of measurement is not specified (L1, L2, L1-L2, iono-free)
Local Observation Set	An observation set, as described below, taken by the receiver on which the software is operating as opposed to an observation taken at another receiver (the reference station) and transmitted through a radio link.
Local Tangent Plane	A coordinate system based on a plane tangent to the ellipsoid's surface at the user's location. The three coordinates are east, north and up. Latitude, longitude and height positions operate in this coordinate system.
Low-latency Solution	A position solution which is based on a prediction. A model (based on previous reference station observations) is used to estimate what the observations will be at a given time epoch. These estimated reference station observations are combined with actual measurements taken at the remote station to provide a position solution.
Magnetic Bearing	Bearing relative to magnetic north; compass bearing corrected for deviation.
Magnetic Heading	Heading relative to magnetic north.
Magnetic Variation	The angle between the magnetic and geographic meridians at any place, expressed in degrees and minutes east or west to indicate the direction of magnetic north from true north.
Mask Angle	The minimum GPS satellite elevation angle permitted by a particular receiver design. Satellites below this angle will not be used in position solution.
Matched Observation Set Pair	Observations from both the reference station and the local receiver which have been matched by time epoch, contain the same satellites, and are corrected for any known offsets.
Measurement Error Variance	The square of the standard deviation of a measurement quantity. The standard deviation is representative of the error typically expected in a measured value of that quantity.
Measurement Time Epoch	The point in time at which a GPSCard takes a measurement.
Multipath Errors	GPS positioning errors caused by the interaction of the GPS satellite signal and its reflections.
Non-Volatile Memory	A type of memory device that retains data in the absence of a power supply.
Null Field	By NMEA standard, indicates that data is not available for the field. Indicated by two ASCII commas, i.e., ",," (HEX 2C2C), or, for the last data field in a sentence, one comma followed by either the checksum delimiter "*" (HEX 2A) or the sentence delimiters <CR><LF> (HEX 0D0A). [Note: the ASCII Null character (HEX 00) is <u>not</u> to be used for null fields.]
Obscuration	Term used to describe periods of time when a GPS receiver's line-of-sight to GPS satellites is blocked by natural or man-made objects.
Observation	Any measurement. The two observations used in NovAtel's RTK algorithms are the pseudorange measurement and the carrier phase measurement.

Observation Set	A set of GPSCard measurements taken at a given time which includes one time for all measurements, and the following for each satellite tracked: PRN number, pseudorange or carrier phase or both, lock time count, signal strength, and tracking status. Either L1 only or L1 and L2 measurements are included in the set. The observation set is assumed to contain information indicating how many satellites it contains and which ones have L1-only and which ones have L1/L2 pairs.
Origin Waypoint	The starting point of the present navigation leg, expressed in latitude and longitude.
Parallel Receiver	A receiver that monitors four or more satellites simultaneously with independent channels.
Parity	The even or odd quality of the number of ones or zeroes in a binary code. Parity is often used to determine the integrity of data especially after transmission.
Perigee	The point in a body's orbit at which it is nearest the earth.
P-Code	Precise code or protected code. A pseudorandom string of bits that is used by GPS receivers to determine the range to the transmitting GPS satellite. P-code is replaced by an encrypted Y-code when Anti-Spoofing is active. Y-code is intended to be available only to authorized (primarily military) users. [See <i>Anti-Spoofing</i> , <i>C/A Code</i> and <i>Y-Code</i>]
PDOP	Position Dilution of Precision [See <i>DOP</i>]
Precise Positioning Service (PPS)	The GPS positioning, velocity, and time service which is available on a continuous, worldwide basis to users authorized by the U.S. Department of Defence (typically using P-Code).
PRN Number	A number assigned by the GPS system designers to a given set of pseudorandom codes. Typically, a particular satellite will keep its PRN (and hence its code assignment) indefinitely, or at least for a long period of time. It is commonly used as a way to label a particular satellite.
Pseudolite	An Earth-based transmitter designed to mimic a satellite. May be used to transmit differential corrections.
Pseudorange	The calculated range from the GPS receiver to the satellite determined by taking the difference between the measured satellite transmit time and the receiver time of measurement, and multiplying by the speed of light. Contains several sources of error.
Pseudorange Measurements	Measurements made using one of the pseudorandom codes on the GPS signals. They provide an unambiguous measure of the range to the satellite including the effect of the satellite and user clock biases.
Receiver Channels	A GPS receiver specification which indicates the number of independent hardware signal processing channels included in the receiver design.
Reference Satellite	In a double difference implementation, measurements are differenced between different satellites on one receiver in order to cancel the correlated errors. Usually one satellite is chosen as the "reference", and all others are differenced with it.
Reference Station	The GPS receiver which is acting as the stationary reference. It has a known position and transmits messages for the rover receiver to use to calculate its position.
Relative Bearing	Bearing relative to heading or to the vessel.
Remote/ Rover Receiver	The GPS receiver which does not know its position and needs to receive measurements from a reference station to calculate differential GPS positions. (The terms remote and rover are interchangeable.)
Residual	In the context of measurement, the residual is the misclosure between the calculated measurements, using the position solution and actual measurements.

Root Mean Square (RMS)	A probability level of 68%.
Route	A planned course of travel, usually composed of more than one navigation leg.
RT-20	NovAtel's Double Differencing Technology for real-time kinematic (RTK) carrier phase floating ambiguity resolution.
Radio Technical Commission for Aeronautics (RTCA)	An organization which developed and defined a message format for differential positioning. See <i>Appendix F Standards and References on Page 239</i> for further information.
Radio Technical Commission for Maritime Services (RTCM)	An organization which developed and defined the SC-104 message format for differential positioning. See <i>Appendix F Standards and References on Page 239</i> for further information.
Real-Time Kinematic (RTK)	A type of differential positioning based on observations of carrier phase. In this document it is also used with reference to RT-2 and RT-20.
Selected Waypoint	The waypoint currently selected to be the point toward which the vessel is travelling. Also called "to" waypoint, destination or destination waypoint.
Selective Availability (SA)	The method used by the United States Department of Defence to control access to the full accuracy achievable by civilian GPS equipment (generally by introducing timing and ephemeris errors).
Sequential Receiver	A GPS receiver in which the number of satellite signals to be tracked exceeds the number of available hardware channels. Sequential receivers periodically reassign hardware channels to particular satellite signals in a predetermined sequence.
Spherical Error Probable (SEP)	The radius of a sphere, centred at the user's true location, that contains 50 percent of the individual three-dimensional position measurements made using a particular navigation system.
Spheroid	Sometimes known as ellipsoid; a perfect mathematical figure which very closely approximates the geoid. Used as a surface of reference for geodetic surveys.
Standard Positioning Service (SPS)	A positioning service made available by the United States Department of Defence which is available to all GPS civilian users on a continuous, worldwide basis (typically using C/A Code).
Space Vehicle ID (SV)	Sometimes used as SVID. A unique number assigned to each satellite for identification purposes. The 'space vehicle' is a GPS satellite.
TDOP	Time Dilution of Precision [See <i>DOP</i>]
Three-Dimensional Coverage	The number of hours-per-day when four or more satellites are available with acceptable positioning geometry. Four visible satellites are required to determine location and altitude.
Three-Dimensional (3D) Navigation	Navigation mode in which altitude and horizontal position are determined from satellite range measurements.
Time-To-First-Fix (TTFF)	The actual time required by a GPS receiver to achieve a position solution. This specification will vary with the operating state of the receiver, the length of time since the last position fix, the location of the last fix, and the specific receiver design.
Track	A planned or intended horizontal path of travel with respect to the Earth rather than the air or water. The track is expressed in degrees from 000° clockwise through 360° (true, magnetic, or grid).
Track Made Good	The single resultant direction from a point of departure to a point of arrival or subsequent position at any given time; may be considered synonymous with Course Made Good.

True Bearing	Bearing relative to true north; compass bearing corrected for compass error.
True Heading	Heading relative to true north.
Two-Dimensional Coverage	The number of hours-per-day with three or more satellites visible. Three visible satellites can be used to determine location if the GPS receiver is designed to accept an external altitude input.
Two-Dimensional (2D) Navigation	Navigation mode in which a fixed value of altitude is used for one or more position calculations while horizontal (2D) position can vary freely based on satellite range measurements.
Undulation	The distance of the geoid above (positive) or below (negative) the mathematical reference ellipsoid (spheroid). Also known as geoidal separation, geoidal undulation, geoidal height.
Update Rate	The GPS receiver specification which indicates the <u>solution rate</u> provided by the receiver when operating normally.
UTC	[See <i>Coordinated Universal Time</i>]
VDOP	Vertical Dilution of Precision [See <i>DOP</i>]
Variable Field	By NMEA standards, a data field which may or may not contain a decimal point and which may vary in precision following the decimal point depending on the requirements and the accuracy of the measuring device.
World Geodetic System 1984 (WGS84)	An ellipsoid designed to fit the shape of the entire Earth as well as possible with a single ellipsoid. It is often used as a reference on a worldwide basis, while other ellipsoids are used locally to provide a better fit to the Earth in a local region. GPS uses the centre of the WGS-84 ellipsoid as the centre of the GPS ECEF reference frame.
Waypoint	A reference point on a track.
Wide Lane	A particular integer ambiguity value on one carrier phase range measurement or double difference carrier phase observation when the difference of the L1 and L2 measurements is used. It is a carrier phase observable formed by subtracting L2 from L1 carrier phase data: $\Phi' = \Phi_1 - \Phi_2$. The corresponding wavelength is 86.2 cm
Y-Code	An encrypted form of P-Code. Satellites transmit Y-Code in replace of P-Code when Anti-Spoofing is in effect. [See <i>P-Code</i> and <i>Anti-Spoofing</i>]

L**GPS GLOSSARY OF ACRONYMS**

1PPS	One Pulse Per Second
2D	Two Dimensional
3D	Three Dimensional
A/D	Analog-to-Digital
ADR	Accumulated Doppler Range
AGC	Automatic Gain Control
AS	Anti-Spoofing
ASCII	American Standard Code for Information Interchange
AVL	Automated Vehicle Locations
BIH	Bureau l'International de l'Heure
BIST	Built-In-Self-Test
BPS	Bits per Second
C/A Code	Coarse/Acquisition Code
CEP	Circular Error Probable
CMR	Compact Measurement Record
CoCom	Coordinating Committee on Multilateral Export Controls
CPU	Central Processing Unit
CR	Carriage Return
CRC	Cyclic Redundancy Check
CTP	Conventional Terrestrial Pole
CTS	Conventional Terrestrial System or Clear To Send
dB	Decibel
DCD	Data Carrier Detected
DCE	Data Communications Equipment (Modem)
DGNSS	Differential Global Navigation Satellite System
DGPS	Differential Global Positioning System
DLL	Delay Lock Loop
DOP	Dilution Of Precision
DRAM	Dynamic Random Access Memory
DSP	Digital Signal Processor
DSR	Data Set Ready
DTE	Data Terminal Equipment
DTR	Data Terminal Ready
ECEF	Earth-Centred-Earth-Fixed
EGNOS	European Geo-Stationary Navigation System
ESN	Electronic Serial Number
ESD	Electrostatic Discharge
FEC	Forward Error Correction
FR	Factory Reset
FTS	Frequency and Time Standard
GDOP	Geometric Dilution Of Precision
GLONASS	Global Navigation Satellite System
GMT	Greenwich Mean Time
GND	Ground
GPS	Global Positioning System
HDOP	Horizontal Dilution Of Precision
HTDOP	Horizontal position and Time Dilution Of Precision
IC	Integrated Circuit
IF	Intermediate Frequency
IGRF	International Geometric Reference Field
I/O	Input/Output
INS	Inertial Navigation System
IODE	Issue of Data (Ephemeris)
IRQ	Interrupt Request
LAAS	Local Area Augmentation System
LF	Line Feed

LHCP	Left Hand Circular Polarization
LNA	Low Noise Amplifier
LO	Local Oscillator
LSB	Least significant bit
MET	Multipath Elimination Technology
MEDLL	Multipath Estimation Delay Lock Loop
MKI	Mark Input
MSAS	MTSAT Satellite Based Augmentation System
MSB	Most significant bit
MSL	Mean sea level
MSR	Measure Output
MTSAT	Multi-Functional Transport Satellite
N/C	Not Connected
NAVSTAR	NAVigation Satellite Timing And Ranging (synonymous with GPS)
NCO	Numerically Controlled Oscillator
NMEA	National Marine Electronics Association
OEXO	Oven Controlled Crystal Oscillator
OEM	Original Equipment Manufacturer
PC	Personal Computer
P Code	Precise Code
PDOP	Position Dilution Of Precision
PLL	Phase Lock Loop
PPS	Precise Positioning Service or Pulse Per Second
PRN	PseudoRandom Noise number
PV	Position Valid
RAM	Random Access Memory
RF	Radio Frequency
RHCP	Right Hand Circular Polarization
ROM	Read Only Memory
RTCA	Radio Technical Commission for Aviation Services
RTCM	Radio Technical Commission for Maritime Services
RTK	Real Time Kinematic
RTS	Request To Send
RXD	Received Data
SA	Selective Availability
SCAT-I	Special Category I
SEP	Spherical Error Probable
SNR	Signal-to-Noise Ratio
SPS	Standard Positioning Service
SV	Space Vehicle
SVN	Space Vehicle Number
TCXO	Temperature Compensated Crystal Oscillator
TDOP	Time Dilution Of Precision
TTF	Time-To-First-Fix
TXD	Transmitted Data
UART	Universal Asynchronous Receiver Transmitter
USB	Universal Serial Bus
UDRE	User Differential Range Error
UTC	Coordinated Universal Time
VARF	Variable Frequency
VDOP	Vertical Dilution of Precision
WAAS	Wide Area Augmentation System
WGS	World Geodetic System
XTE	Crosstrack Error

Index

1PPS, 34, 85, 130, 220
2D, 99, 165, 269, 274
3D, 165, 269, 273

A

acceleration, 31, 33, 183, 226–227
accept, 23, 81–82
accessories, 18
accumulated doppler, 56
accuracy
 differential positioning, 268
 ephemeris, 269
 selective availability, 273
acquisition, 84, 267, 271, 275
almanac
 data, 31–32, 64, 138, 161, 189, 267, 274
 parameters, 138
 raw, 188–189
 save, 31, 200
 status, 195
 tables, 32
ambiguity, 274
 carrier-phase, 73–74, 267
 estimates, 270
 floating solution, 145
 half cycle, 195
 multipath, 76
 RTK, 119–120, 231, 234, 237
antenna
 altitude, 160, 162
 bit description, 199
 cable, 199
 design, 76–77
 dynamics, 20
 motion, 59, 84
 position, 119, 173, 200
 power, 83
 site, 69, 76
anti-spoofing (AS), 267, 275
ARINC, contact information, 239
ascii, 271
 accept, 81
 data, 32, 43, 123
 hexadecimal, 52
 intermix data, 48
 log structure, 44, 107
 RINEX, 58
 RTCM, 51
 structure, 36
 text message, 54, 115
assign, 84, 131

azimuth, 167, 214, 267

B

baseline, 143
bearing, 77, 108, 175, 267, 271
binary
 conversion, 48
 data, 43
 differential corrections, 81
 example, 199
 header, 48, 53
 log structure, 107
 raw information, 188
 RTCA, 46
 RTCM, 51
 structure, 36
 subframes, 33, 194
 types, 37
bit rate, 18
broadcast
 almanac data, 161
 carrier-phase, 73
 control segment, 64
 differential corrections, 16
 ephemeris, 69
 health, 126
 navigation, 57, 204
 pseudorange corrections, 68
 raw almanac, 188
 RINEX, 60, 114
 RTCM, 54, 56
buffer overload, 36

C

C/A code, 64, 68, 76–77, 79, 273
carrier
 smoothing, 90
 to noise density ratio (C/No), 157, 167, 196, 201
carrier-phase
 algorithms, 73
 ambiguities, 267
 differential positioning, 67
 error estimate, 195
 fix position, 100
 jump, 199
 mode, 53, 56
 multipath, 76
 range measurements, 196
 wide lane, 274
cartesian coordinate position, 185

- channels, 269, 272–273
 - L1/L2, 212
 - number of, 193, 212
 - phase lock, 196
 - range measurements, 195
 - reacquisition, 33
 - status, 84, 157, 193, 196, 203, 228
 - unassign, 131
 - chatter, 32, 45
 - checksum, 25, 34, 193, 267, 269, 271
 - header, 47
 - log structure, 36
 - RINEX, 58
 - RTCM, 52
 - terminator, 51
 - clock
 - adjust, 85, 199
 - bias, 66, 74, 272
 - cesium or rubidium, 97
 - channel range measurements, 195
 - data, 64
 - dither, 96
 - drift, 54, 85, 149
 - error, 38, 84
 - external, 54, 97
 - matrices, 151
 - offset, 38, 68–69, 100, 149, 155, 174, 220, 269
 - parameters, 57, 60, 96
 - pass-through record, 43
 - satellite, 218
 - set, 34
 - status, 149, 220
 - synchronization, 130
 - CMR, 18–19, 46, 57
 - accept, 81–82
 - status, 146–147
 - COM
 - buffers, 200
 - port, 32, 34, 47–48, 52, 81, 86, 107, 123
 - command interpreter, 245
 - communications port, 48, 51–53, 123
 - configuration
 - antenna power, 83
 - channel, 88
 - differential, 72
 - factory default, 112
 - log, 50, 54
 - quick start, 13
 - receiver, 34, 36, 192
 - reset, 89, 103, 112
 - satellite, 188
 - signal delays, 127
 - status, 15
 - constellation, 63, 155, 237, 270
 - control segment, 63–64, 69, 126
 - conversion, 65, 196, 242, 267
 - coordinated universal time (UTC), 229, 268
 - almanac data, 31, 138, 140, 188, 229
 - NMEA, 160, 162, 166, 171–172
 - offset, 39, 174, 220
 - parameters, 32–33
 - RINEX, 57, 60
 - course over ground, 268
 - CPU, 36, 193, 200
 - cross track, 168, 175, 268
 - Customer Service, 10–11
- ## D
- data
 - link, 16, 18–19
 - status, 163
 - datum, 270
 - cartesian coordinate position, 185
 - choice, 100, 132, 135, 178, 183, 185, 226
 - command, 91
 - computed position, 180
 - ID, 173, 180
 - navigation, 128, 175
 - tables, 240
 - default, 13
 - delay, 21, 79, 92
 - deweight, 106, 155
 - differential corrections, 71, 272
 - accept, 81
 - accuracy, 71
 - age, 185, 222
 - dgps delay, 92
 - disable, 99
 - dual station, 73, 123
 - fix position, 100, 160
 - lag, 185
 - log trigger, 15, 35
 - message formats, 48, 51–52, 54
 - outages, 181
 - position averaging, 111
 - RTK, 34, 238
 - single point averaging, 70
 - special data input, 31
 - station ID, 125
 - dilution of precision (DOP), 269–270, 275
 - log, 155–156
 - NMEA, 160, 162, 164–165
 - positioning, 67
 - quick start, 16
 - RTK, 234
 - direction
 - of motion, 217
 - over ground, 222
 - distance
 - conversion, 242
 - to destination waypoint, 175
 - DOP, *see* dilution of precision
 - Doppler, 269, 275

- accumulated, 56, 196, 202
- frequency, 84
- instantaneous, 196
- jump, 199
- offset, 84
- velocity, 222

double differencing, 80, 273

E

earth-centered earth-fixed (ECEF), 119, 143, 183, 205, 218, 226, 269

- differential corrections data, 33
- fix, 101
- message formats, 53

elevation

- cut-off, 90, 95, 131
- highest, 74
- multipath, 77
- RTK, 118, 232, 234
- satellite, 167, 214

ellipsoid, 20, 270, 273–274

- choice, 183, 226
- customized, 135
- datum, 135
- navigation, 128
- rectangular coordinates, 53
- reference, 178
- RTK, 119
- tables, 240
- time matched position, 207
- undulation, 132
- WGS 84, 33

ephemeris

- change in, 52
- corrected, 63–64
- data, 21, 64, 189
- delay, 47, 92
- errors, 69, 71, 237, 273
- raw data, 33
- time of (TOE), 194
- updated, 56

errors

- checksum, 25
- clock, 85, 96
- CPU, 200
- cross track, 168
- ephemeris, 237
- extrapolation, 18
- fix position, 100
- ionospheric, 231
- messages, 44, 81, 110
- multipath, 76, 195, 271
- pseudorange, 268
- relative positioning, 66
- steering, 270

external oscillator, 34, 96–98

F

factory default, 24, 89, 103, 112

first in first out (FIFO), 86

flag

- antenna motion, 59, 83
- buffer, 199–200
- constellation, 152
- CPU, 200
- ellipsoid, 119
- handshaking protocol, 146
- new site occupation, 62
- occupation, 62
- parity, 195
- status, 38, 181, 184
- time synchronization, 130

frequency

- carrier-phase, 73–74
- Doppler, 84, 157, 196–197, 201, 269
- dual, 46, 49
- external clock, 96, 98
- ground planes, 78
- L-band, 64
- lock, 203
- output pulse, 102
- period, 35
- RTK, 231, 237
- single, 57
- single point averaging, 70

G

Gauss-Markov process, 151

GDOP, *see* dilution of precision

GEO, WAAS, 30–31, 105, 224

geodetic datum, 91, 240, 270

Geodetic Survey of Canada, contact information, 239

geographic coordinates, 180

geoid, 269, 273–274

- antenna altitude, 160, 162
- fix height, 99
- relationship to undulation, 178
- separation, 160, 180
- undulation, 132, 173

Global Positioning System (GPS), overview, 63

GLONASS, 229

GPS time, 38–39, 45, 57, 60

- adjust, 85
- conversion, 243
- errors, 69
- fix position, 100
- offset, 149

GPSAntenna, 13

GPSolution software, 14

graphical interface, 13

great circle, 128, 268, 270

ground plane, 76, 78, 237

H

hardware reset, 112
 HDOP, *see* dilution of precision
 heading, 217, 222, 268, 270
 health

- almanac, 138
- log, 21
- raw almanac, 188
- reference station, 205, 238
- reset, 113
- satellite, 57, 60, 100, 131, 218
- set, 126
- station, 20
- SV, 161
- velocity, 222

 height

- at time of mark, 173
- between stations, 237
- computed position, 180
- dilution of precision, 269
- ellipsoidal, 20, 119
- fix, 73, 99–100
- illustration, 65
- multipath, 77
- parameter, 178

 help, 24, 104
 hexadecimal, 124
 high power jamming, 199–200
 HTDOP, *see* dilution of precision

I

I/O, 13
 idle time, 193, 200
 Inertial Navigation System (INS), 101, 183
 information messages, 244–247
 initialization, 16, 19
 installation, 13
 International Geomagnetic Reference Field (IGRF), 108
 ionospheric

- configuration data, 188
- corrections, 32, 218
- data, 31, 138
- delays, 57, 60, 71
- errors, 231
- parameters, 32

J

jamming signal, 199–200

K

kinematic, 270

- convergence, 236
- logs, 21, 37
- multipath, 79

RINEX observation event, 59
 RTK, 120
 solutions, 73
 versus static, 67

L

latched time, 173
 latency, 271

- carrier-phase, 74
- in velocity time tag, 222
- log, 37
- position, 21
- positioning, 68, 181
- reducing, 54
- reference station, 238
- RTK, 234
- time matched, 207

 latitude and longitude, 269, 272

- fix, 73, 100, 160, 162
- navigation, 169
- overview, 63
- positioning, 163, 173, 180, 207
- RTK, 119

 L-band frequency, 64
 LED, 13
 license, 10
 listing of tables, 248–255, 257–265
 LNA, *see* low noise amplifier
 lockout satellite, 106
 locktime, 90, 196
 low noise amplifier (LNA), 83, 199

M

magnetic variation, 108–109, 169, 175, 271
 mask angle, 143–144, 181–182, 207, 232, 271
 master control station, 64, 268
 matched baseline, 143
 mean sea level, 270, 276

- antenna altitude, 162
- computed position, 180
- fix height, 20, 99
- overview, 63–65
- RTK, 119

 messages

- information, 244–247
- log, 110

 misclosure, 272
 modem, 43, 46, 110, 154
 monitor station, *see* reference station
 mount, 13
 multipath, 75–80

- errors, 195, 237
- reduction, 68
- RTK, 232

N

Narrow Correlator tracking technology, 68, 79

navigation

- 2D, 274
- accuracy, 54
- calculations, 128
- data, 169
- ephemeris, 269
- fix velocity, 101
- illustration, 177
- information, 168
- message, 57, 60
- overview, 63
- parameters, 175, 177
- path, 128
- progress, 128, 175
- RINEX, 114, 204
- satellite system, 275
- satellites, 165
- set, 128
- standards, 48, 206

NAVSTAR satellites, 63, 270, 276

NMEA standard format, 14, 35, 38, 239

noise

- antenna, 83
- carrier smoothing, 90
- carrier-phase, 74
- clock offset, 151
- interference, 68
- multipath, 79
- number, 276
- oscillators, 96–97
- reduction, 68
- RTK, 237
- statistics, 39, 166
- thermal, 195

non-printable characters, 124

non-volatile memory (NVM), 25, 32, 58, 103, 199–200, 271

note, 15, 18, 22, 25, 32–34, 52

NovAtel Inc., 10

NVM, *see* non-volatile memory

O

offset

- antenna, 73
- clock, 68, 96, 100, 149, 155
- Doppler, 84
- L1, 127
- log, 107
- parameters, 15, 35
- pseudorange, 73
- time, 39
- track, 128

operation, quick start, 13

orbit period, 63

oscillators, 13, 34, 69, 85, 96–98, 149, 276

output pulse, 102

P

P code, 267

pass-through logs, 43–45, 81, 110, 154

PDOP, *see* dilution of precision (DOP)

phase lock, 76, 84, 196

pitch, 77

polarity, 75

poor reception, 77

ports

- COM, 32, 34, 47–48, 52, 81, 86, 107, 123, 200
- communication, 48, 52–53, 123

position

- averaging, 111
- constraints, 133
- fix, 162–163
- satellite, 226
- status, 23
- time matched, 207
- type, 145
- unfix, 133

processing

- channel range measurements, 195
- channels, 272
- Doppler aiding, 269
- equipment, 64
- extra, 51
- modes, 81
- post-mission, 67
- priority, 200
- real-time, 65, 67
- synchronized data, 157

propagation

- delays, 69
- multipath, 77, 80
- paths, 75

pseudorange, 272

- carrier smoothing, 90
- differential corrections, 23, 51, 54, 181, 232
- errors, 66, 69, 195
- fix height, 99
- fix position, 100
- jump, 199
- L1 offset, 127
- measurements, 57, 60, 73
- message formats, 56
- multipath, 73, 76
- Narrow Correlator tracking technology, 79
- noise statistics, 166
- positioning, 67
- solution, 37

pulse, 275–276

- length of, 34
- mark input, 173–174
- time of, 220

Q

quick start, 13

R

radio frequency (RF), 75, 78, 199, 267

RAM, 199

range

- corrections, 228
- reject codes, 215

raw

- almanac, 161, 188–189
- framed navigation data, 159

reacquisition, 33, 84, 101, 183

real-time

- carrier-phase, 73
- multipath, 70
- positioning, 66
- processing, 65, 67
- RT-20, 273
- RTK, 231

receiver status, 36, 121, 193–200, 212

receiver-independent exchange format (RINEX), 204

redirect data, 43, 154

reference station

- baseline, 143
- carrier smoothing, 90
- carrier-phase, 74
- data link, 123
- dgps delay, 92
- fix, 99–100
- health, 205, 238
- ID, 125
- link, 207
- multipath, 76
- observation, 181
- overview, 73
- parameters, 268
- position averaging, 111
- RTK, 117, 120
- single point averaging, 70

references and standards, 239

reject code, 214

remote station, 271

- accuracy, 66
- baseline, 143
- carrier smoothing, 90
- carrier-phase, 74
- data link, 123
- differential positioning, 71
- fix, 100
- overview, 73
- pseudorange corrections, 68
- RTK, 117–118, 120

reset

- configuration, 89
- hardware, 112

health, 113

non-volatile memory, 103

residual, 272

residual, satellite data, 164, 214

RF, *see* radio frequency

RMS, *see* root mean square

roll, 77

root mean square (RMS), 166, 234, 273

rover station, *see* remote station

RTCA, 14, 19–20, 22, 35, 46–48, 273

accept, 81–82

contact information, 239

dgps delay, 92

logs, 206

station ID, 125

status, 146

RTCM, 14, 19, 22, 35, 46, 52–53

accept, 82

bit rule, 116

contact information, 239

logs, 206

station ID, 125

status, 146

RTK

comparison, 231–238

link, 238

status, 145

S

satellite

active, 165

almanac, 32, 138, 267

assign, 84

channels, 103, 195, 212

clock dither, 96

configuration, 188

coordinates, 218, 226

corrections, 228

data, 214

dilution of precision, 16, 155

elevation cut-off, 118

fix position, 100

health, 57, 60, 113, 126, 131, 218

ID, 52, 54

in view, 167

lockout, 106

loss of lock, 77, 101

multipath, 75

number of, 56

observation information, 19

orbit arrangement, 63

range residuals, 164

raw ephemeris, 194

reacquisition, 183, 237

receiver time, 199

record, 46

- reference station, 49
 - reset, 90
 - RTK, 120, 234
 - system, 47, 206
 - tracking, 34
 - unlock, 133
 - segment
 - (space, control and user), 63–64
 - control, 267–268
 - segment (space, control and user), 63
 - self-test, 13, 36, 196, 275
 - send
 - ascii data, 123
 - non-printable characters, 124
 - set
 - health, 126
 - L1 offset, 127
 - single point
 - averaging, 70
 - positioning, 23
 - smoothing, 90
 - software
 - licence, 10
 - updates or upgrades, 11
 - version, 136, 221
 - solution type, 144
 - space
 - memory buffer, 36
 - segment, 63
 - separator, 24
 - three-dimensional, 66, 185
 - vehicle channel, 84
 - vehicle number (SVN), 63
 - special command data, 31
 - speed, 268, 272
 - data, 169
 - light, 68
 - logging, 36
 - navigation, 175
 - over ground, 169–170, 217, 222
 - relative to ground, 170
 - standards and references, 239
 - station ID, 20, 49, 100, 125, 205
 - status
 - clock, 220
 - position, 23
 - receiver, 31, 36, 193
 - subframes, 33, 138, 188, 194
- T**
- tables, listing of, 248–265
 - tag
 - external events, 45
 - time, 57, 59, 62
 - TCXO, *see* oscillators
 - TDOP, *see* dilution of precision
 - terminal emulator, 32
 - time
 - fix, 162
 - GPS, 38, 45, 57, 60
 - latched, 173
 - matched, 207
 - of pulse, 220
 - synchronization, 130
 - tag, 43, 57, 59, 62, 143, 205, 222
 - tip, 34
 - track
 - made good, 169–170, 268, 273
 - offset, 128
 - over ground, 217, 222
 - tracking
 - assign, 84
 - automatic, 131
 - carrier smoothing, 90
 - cycle slip, 268
 - loops, 73, 183, 195, 200
 - loss, 237
 - number, 155, 212
 - RTK performance, 234
 - satellites, 32, 34, 267
 - status, 157, 195–196, 203, 228, 272
 - transformation parameters, 240
 - triangulation, 76
 - trigger, 14–15, 25, 35, 43, 107
 - trilateration, 76
 - tropospheric, 218
 - true north, 108, 166, 175, 267, 271, 274
- U**
- U.S. National Geodetic Survey, contact information, 239
 - undulation, 274
 - at time of mark, 173
 - computed position, 180
 - estimate, 20
 - illustration, 132
 - relationship to geoid, 178
 - RTK, 119
 - time matched position, 207
 - update or upgrade software, 11
 - user
 - datum, 175
 - segment, 63–64
 - UTC, *see* coordinated universal time
- V**
- VCTCXO, *see* oscillators
 - VDOP, *see* dilution of precision
 - velocity, 269, 272
 - accurate, 64
 - computation, 222, 226
 - data, 23, 63
 - fix, 101
 - health, 222

- high dynamics, 33
- latency, 222
- navigation, 175
- overview, 63
- quality, 222
- satellite, 226
- status, 183, 223
- version, 136, 221

W

WAAS

- almanac, 224–225
- commands, 31
- concept, 30
- corrections, 137
- framed raw navigation data, 159
- GPSCard, 31
- ionospheric model, 105
- logs, 43
- waypoint, 268, 273–274
 - destination, 168, 172
 - ID, 172
 - navigation, 128, 175

WGS-84, 274

- cartesian coordinate position, 185
- computed position, 180
- customized ellipsoid, 135
- datum choice, 91, 100
- illustration, 187
- rectangular coordinates, 33
- reference station, 53
- set navigation, 128
- single point averaging, 70
- SV position, 218, 226
- undulation, 132

Y

- Y code, 267

